



BMR 350

600 W digital quarter brick DC/DC IBC

The BMR350 is a new generation of high-power digital DC/DC converter. The impressive performance of this converter includes an efficiency reaching 98% at 49V V_{in} at full load.

The BMR350 is a non-isolated quarter brick, and has a low building height of only 13.2 mm. The converter delivers a fully regulated 12.12 V. The BMR350 delivers a continuous power level of 600 W.

This converter is designed for through-hole mounting using wave solder or pin-in-paste production, and incorporates a novel design of baseplate, which optimizes thermal performance while minimizing height.



Key features

- High efficiency with 98%
- Non-isolated
- 12.12 V fully regulated
- Event data recorder (black-box)
- Screwed baseplate
- Monotonic start-up
- Output over voltage protection
- Over temperature protection
- Output short-circuit protection
- Remote control
- PMBus configuration
- Remote sense function
- Halogen free

Soldering methods

- Reflow soldering Pin-in-paste
- Wave soldering
- Manual soldering

Key electrical information

Parameter	Values
Input range	40-60 V
Output voltage	12.12 V
Output current	50 A
Output power	600 W

Mechanical

58.4 x 36.8 x 13.3 mm / 2.30 x 1.45 x 0.52 in

Application areas

- Datacom applications

Product options

The table below describes the different product options.

Example: BMR350		2	3	20	/802	H	Definitions
Product family	BMR350						
Pin length options		2					0 = 5.33 mm / 0.21 in 2 = 3.69 mm / 0.15 in 3 = 4.57 mm / 0.18 in 4 = 2.79 mm / 0.11 in
Baseplate / HS option			3				3 = baseplate
Other hardware options				20			20 = 600W with 7-pin digital header and sense pin
Configuration code					/802		/802=12.12 V _{out} sense function config. for 40-60 V _{in}
Packaging options						H	E = soft tray, dry pack (PIP reflow soldering) H = hard tray, dry pack (PIP reflow soldering) blank = foam tray (no dry pack, wave soldering)

For more information, please refer to Part 3 [Mechanical information](#).

If you do not find the variant you are looking for, please contact us at [Flex Power Modules](#).

Order number examples

Part number	V _{in}	Outputs	Configuration
BMR350 2320/802H	40-60 V	12.12V / 50A/ 600 W	3.69 mm pins / 7-pin digital header / base plate / sense / dry pack, hard tray

Part 1: Electrical specifications

Absolute maximum ratings

Stress in excess of our defined *absolute maximum ratings* may cause permanent damage to the converter. Absolute maximum ratings, also referred to as *non-destructive limits*, are normally tested with one parameter at a time exceeding the limits in the electrical specification.

Characteristics	min	typ	max	Unit
Operating temperature (T_{P1})	-40		+125	°C
Storage temperature	-55		+125	°C
Input voltage (V_{in})	-0.5		+65	V
Input voltage transient (100 ms)			+80	V
Isolation voltage (input to output)			0	V
Isolation voltage (baseplate to output)			0	V
Remote control pin voltage	-0.3		5	V

Reliability

Failure rate (λ) and mean time between failures ($MTBF = 1/\lambda$) are calculated based on *Telcordia SR-332 Issue 4: Method 1, Case 3, (80% of I_{out_TDP} , $T_{P1}=40^{\circ}\text{C}$, Airflow=200 LFM)*.

	Mean	90% confidence level	Unit
Steady-state failure rate (λ)	132	161	nfailures/h
Standard deviation (σ)	22.4		nfailures/h
MTBF	7.57	6.22	MHr

Typical application diagram

Capacitor values are defined in the Electrical Specification tables. The EMI filter is defined in the [EMC Part 2](#).

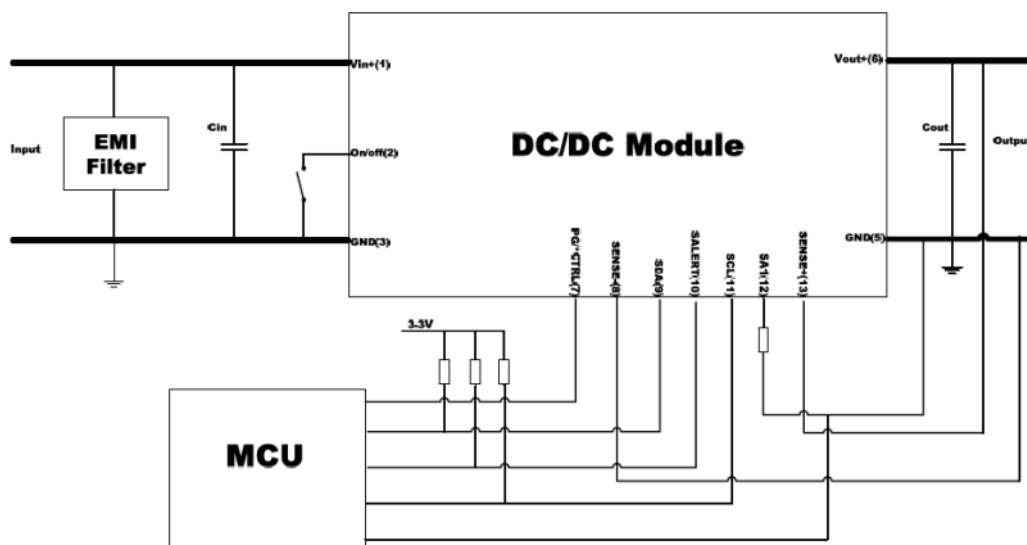

Electrical specifications for BMR350 X320/802**12.12V, 50A \leq 600W**

Min and Max values are valid for: $T_{P1} = -30$ to $+90^{\circ}\text{C}$, $V_{in} = 40\text{V}$ to 60V , unless otherwise specified under conditions. Typical values given at: $T_{P1} = +25^{\circ}\text{C}$, $V_{in} = 49\text{V}$, max P_{out_TDP} , unless otherwise specified under conditions, see Note 1.

Additional external $C_{in} = 470 \mu\text{F}$, $C_{out} = 4.7\text{mF}$

Characteristic	conditions	minimum	typical	maximum	unit
Key features					
Efficiency (η)	80% of P_{out_TDP} $V_{in} = 49 \text{ V}$		98.1		%
	100% of P_{out_TDP} $V_{in} = 49 \text{ V}$		98.0		%
P_{out_TDP} thermal design power (TDP)	See Note 1			600	W
Power dissipation	100% of P_{out_TDP}		11.9		W
Switching frequency (f_s)	0-100 % of P_{out_TDP}		150		kHz
Recommend capacitive load		1000		8000	μF
Input characteristics					
Input voltage range (V_{in})		40		60	V
Input idling power	$P_{out} = 0 \text{ W}$		4.1		W
Input standby power	(turned off with RC)		560		mW
Input OVP			85		V
Internal input capacitance			90		μF
Recommended external input capacitance		220			μF

Note 1: Continuous power (thermal design power (TDP)) is $\leq 600 \text{ W}$ depending on thermal conditions.

Electrical specifications for BMR350 X320/802**12.12V, 50A \leq 600W**

Min and Max values are valid for: $T_{P1} = -30$ to $+90^{\circ}\text{C}$, $V_{in} = 40\text{V}$ to 60V , unless otherwise specified under conditions. Typical values given at: $T_{P1} = +25^{\circ}\text{C}$, $V_{in} = 49\text{V}$, max P_{out_TDP} , unless otherwise specified under conditions, see Note 1.

Additional external $C_{in} = 470 \mu\text{F}$, $C_{out} = 4.7\text{mF}$

Characteristic	conditions	minimum	typical	maximum	unit
Output characteristics					
Output voltage initial setting and accuracy	$P_{out} = \text{half load}$	12	12.12	12.3	V
Output voltage tolerance band	0 – 100% of max P_{out_TDP} $V_{in} = 40\text{-}60\text{ V}$	11.7		12.4	V
Output adjust range	0-100% of max P_{out_TDP}	8		13.2	V
Idling voltage	$P_{out} = 0\text{ W}$, 48 V	12		12.4	V
Line regulation	$V_{in} = 40 - 60\text{ V}$ 0 – 100% of max P_{out_TDP}		3	10	mV
Load regulation	0 - 100% of max P_{out_TDP}		90		mV
Output current (I_{out})	$V_{in} = 40 - 60\text{ V}$	0		50	A
Load transient voltage deviation	Load step 0-100-0% of max P_{out_TDP} $di/dt = 2.5\text{ A}/\mu\text{s}$. See Note 2		± 350		mV
Load transient recovery time			200		μs
Output ripple & noise	max P_{out_TDP} See Note 3		50		mV _{p-p}

Note 1: continuous power (thermal design power (TDP)) is $\leq 600\text{ W}$ depending on thermal conditions.

Note 2: C_{out} is 4.7mF

Note 3: See Technical Reference doc: Design considerations

Electrical specifications for BMR350 X320/802**12.12V, 50A \leq 600W**

Characteristic	conditions	minimum	typical	maximum	unit
On/off control					
Turn-off input voltage	Decreasing input voltage	34	35	36	V
Turn-on input voltage	Increasing input voltage	36	37	38	V
Ramp-up time (from 0–100% of V_{out})			10		ms
Start-up time (from V_{in} connection to 90% of V_{out})			40		ms
RC start-up time			26		ms
Logic high: trigger level			1.4		V
Logic low: trigger level			1.3		V
Logic low: response time		0.1	0.2	0.3	ms
Sink current		0.4			mA
Protection features					
Current limit threshold (OCP)	$T_{P1} < \max T_{P1}$		65		A
Output current limit (OCP) response time and type	Hiccup* 3 + latch		1000		ms
Output overvoltage protection (OVP)			15.6		V
Output overvoltage protection (OVP) response time and type	Disabled until fault cleared		70		μ s
Over temperature protection (OTP)	See note 1		130		$^{\circ}$ C
Over temperature protection (OTP) type	Disabled until fault cleared				ms

Note 1: Please attach thermocouple on NTC resistor to test OTP function, the hot spot (P1) temperature is just for reference.

Electrical specifications for BMR350 X320/802**12.12V, 50A \leq 600W**

In the table below all PMBus are written in capital letters.

T_{P1} = -30 to +90°C, V_{in} = 40V to 60V, unless otherwise specified under conditions.

Typical values given at: T_{P1} = +25 °C, V_{in} = 49V, max P_{out_TDP} , unless otherwise specified under conditions

Command	Conditions	minimum	typical	maximum	Unit
Monitoring accuracy					
Input voltage READ_VIN			±125		mV
Output voltage READ_VOUT			±40		mV
Output current READ_IOUT	$T_{P1} = 25\text{ °C}$, $V_O = 12.12\text{V}$		±0.5		A
	$T_{P1} = -20-120\text{ °C}$, $V_O = 12.12\text{V}$		±2.5		A
Duty cycle READ_DUTY_CYCLE	No tolerance, Read value is the actual value applied by PWM controller				
Temperature READ_TEMPERATURE_1	Temperature sensor, -20-120 °C		±5		°C

For more detailed information please refer to Technical Reference Document: PMBus commands.

This product is supported by the [Flex Power Designer tool](#).

Part 1: Electrical specifications

Electrical specifications for BMR350 X320/802

12.12V, 50A $\leq 600W$

Efficiency

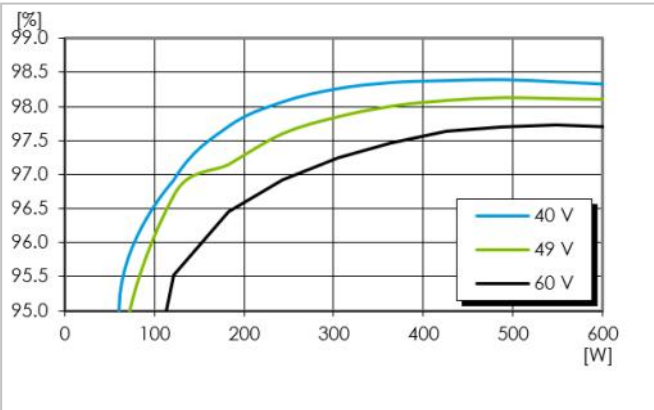

Efficiency vs. output power and input voltage at $T_{PI} = +25^\circ$

Power dissipation

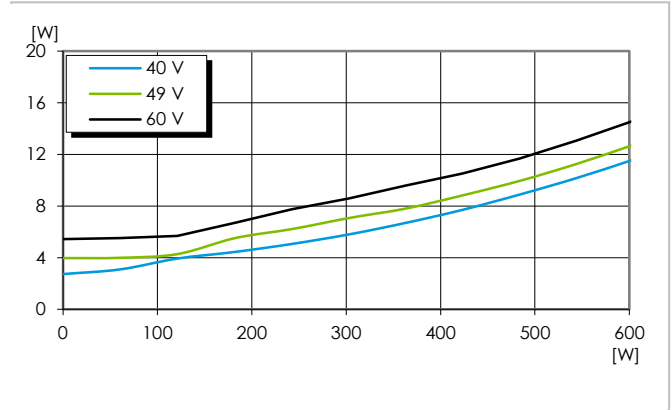

Dissipated power vs. load power at $T_{PI} = +25^\circ$

Line regulation

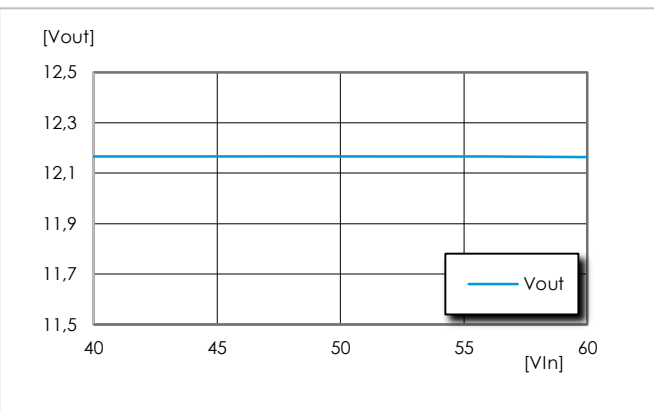

Output voltage vs. input voltage at $T_{PI} = +90^\circ$

Available power

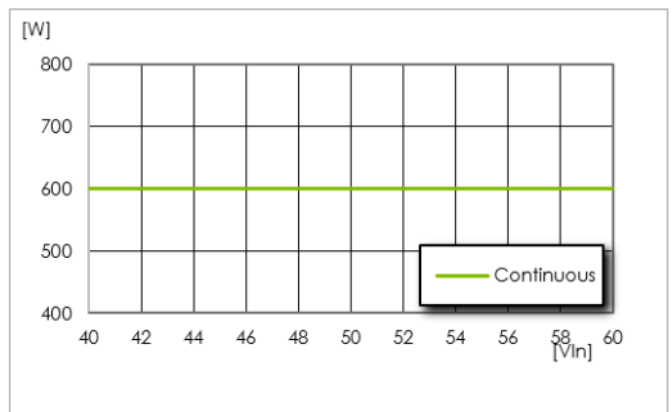

Available output power vs. input voltage, $T_{PI} = +90^\circ$

Power loss at max temperature

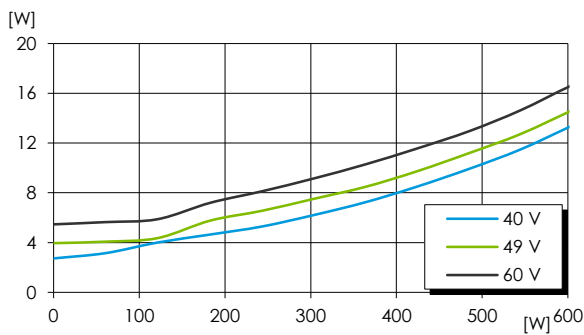

Dissipated power vs. output power and input voltage at $T_{PI} = +90^\circ$

1/28701-BMR 350 2320/802 Rev F

Output voltage adjust range

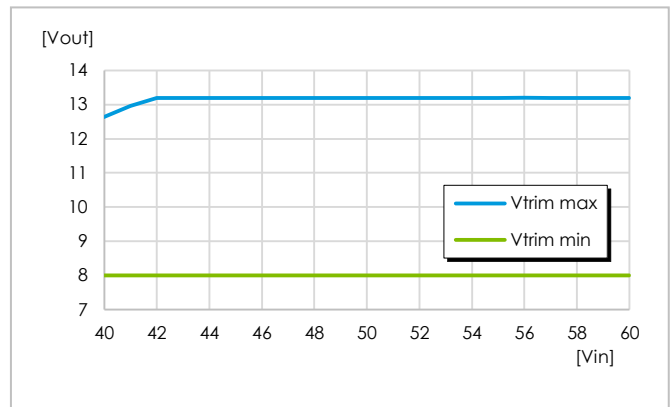

Max and min V_{out} trim vs V_{in}

Part 2: EMC

EMC specifications

Conducted EMI measured according to EN55022 / EN55032, CISPR 22 / CISPR 32 and FCC part 15J (see test set-up below). The fundamental switching frequency is 150kHz for BMR350. The EMI characteristics below is measured at $V_{in} = 49\text{ V}$ and $\max I_{out}$.

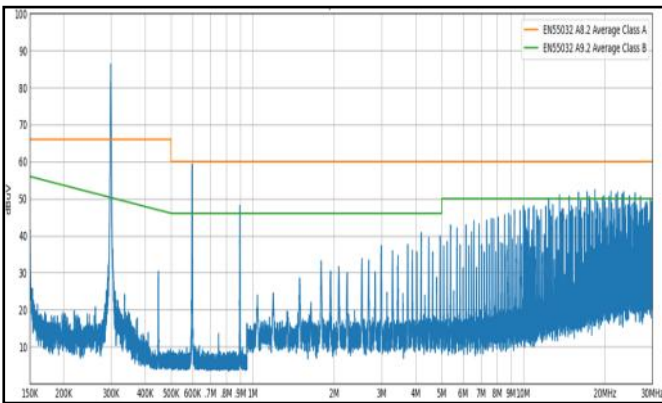

EMI without filter. EN55032 test method and limits are the same as EN55022. 220 µF 100V input capacitor and 1000 µF

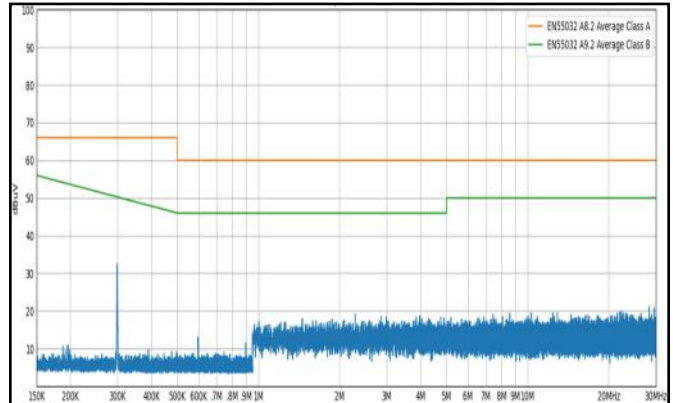

EMI with filter, EN55022 test methods and limits are the same

Optional external filter for Class B

Suggested external input filter in order to meet Class B in EN 55022 / EN 55032, CISPR 22 / CISPR 32 and FCC part 15J.

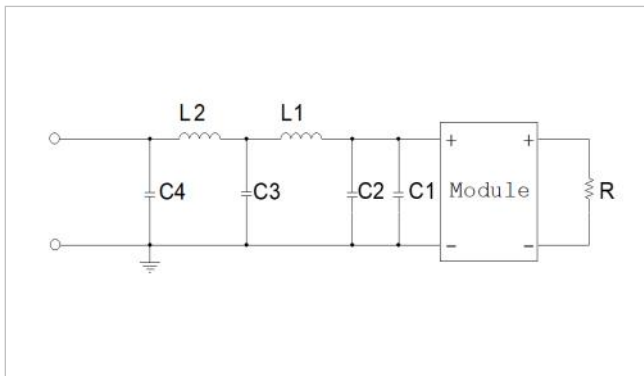

Filter components:
 C1 = 220 µF (e-lyt)
 C2 = 2 x 2.2 µF
 C3, C4 = 2*4.7µF
 L1, L2 = 4.7 µH

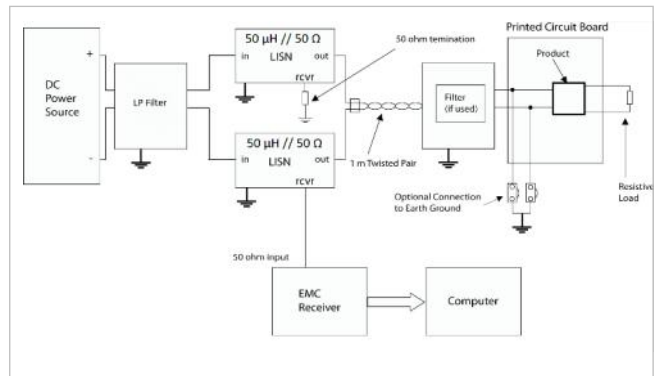

Test set-up

Layout recommendations

The radiated EMI performance of the product will depend on the PWB layout and ground layer design. It is also important to consider the stand-off of the product. If a ground layer is used, it should be connected to the output of the product and the equipment ground or chassis.

A ground layer will increase the stray capacitance in the PWB and improve the high frequency EMC performance.

Part 3: Mechanical information

BMR350 X1XX/XXX: hole mounted, baseplate version

The mechanical information is based on a module which is hole mounted and has a baseplate.

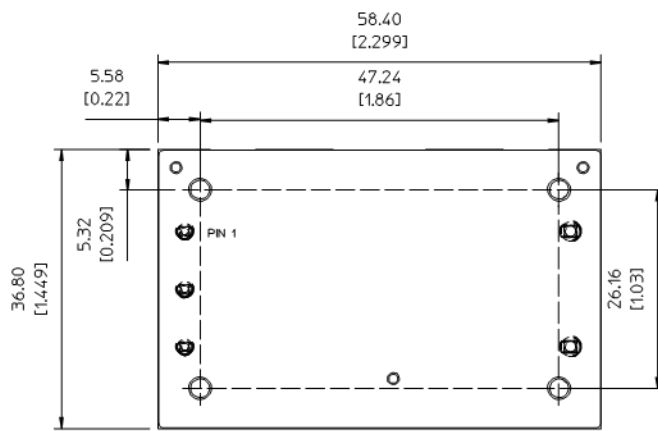
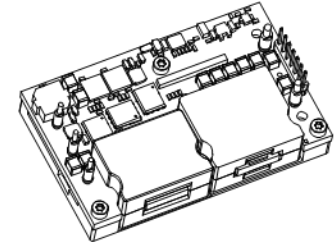
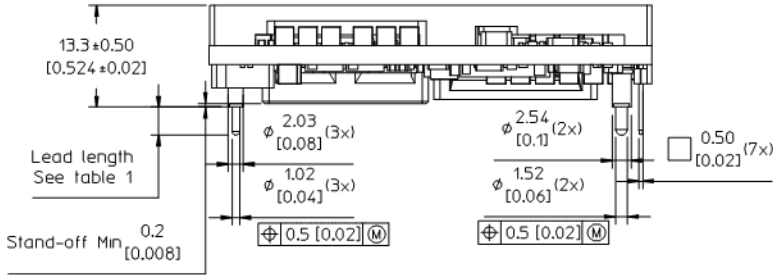

Table 1

	Lead length
Standard	5.33 [0.210]
LA	3.69 [0.145]

PIN SPECIFICATIONS

Pin 1-3, 5,6 Material: Copper alloy
Pin 7-13 Material: Copper alloy
Pin 14, Optional
Plating: Min 0.1 µm Au over 1-3 µm Ni.

CASE

Material: Aluminium
For screw attached apply mounting torque of max 0.44 Nm [3.9lbf in.]
M3 screws must not protrude more than 3.8 mm [0.150] into the baseplate.

Recommended hole dimensions are only for reference. It is the end users decision based on different situations like production processes, substrate thickness etc.

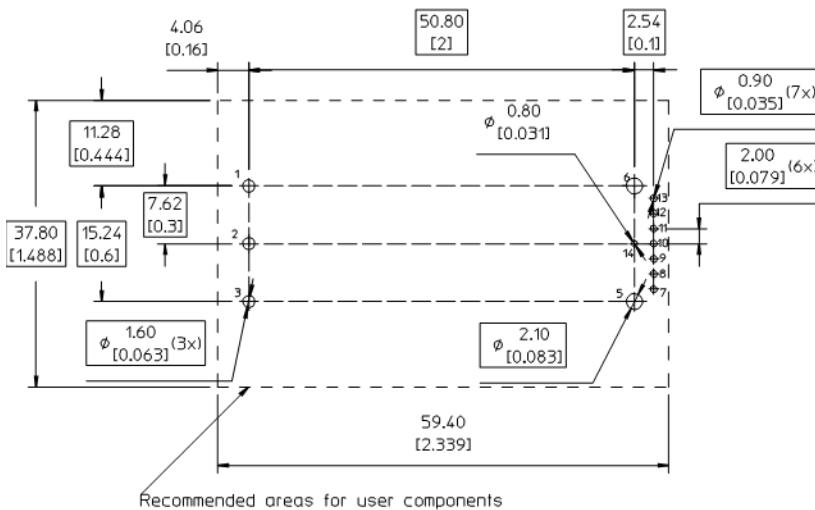

Weight: typical 88 g

All dimensions in mm [inch].

Tolerances unless specified

x.x mm ±0.50 mm [0.02], x.xx mm ±0.25 mm [0.01]
(not applied on footprint or typical values)

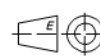

TOP VIEW - Recommended footprint all variants showing pin positions

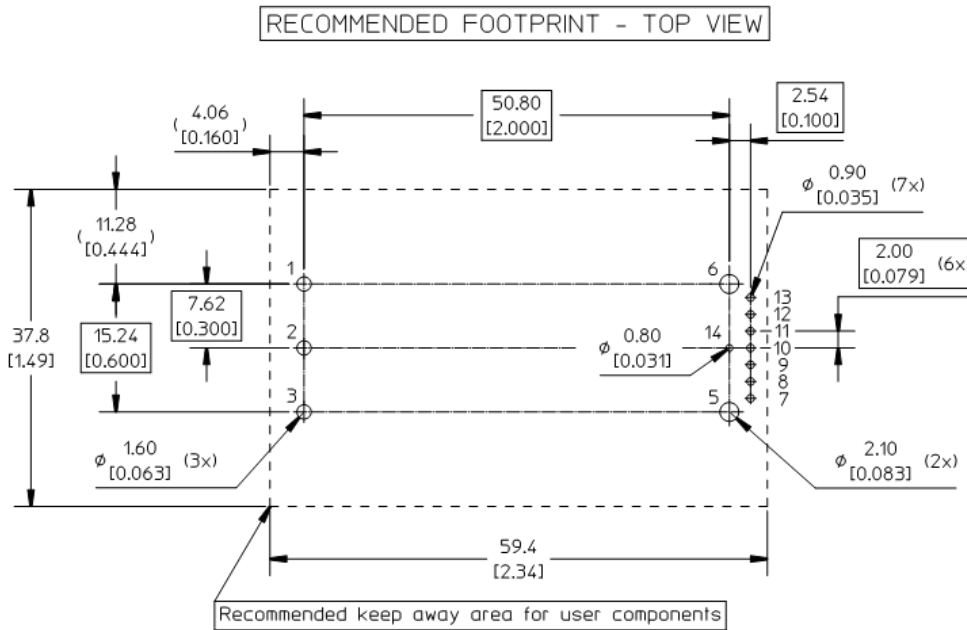

CONNECTIONS - BOTTOM VIEW

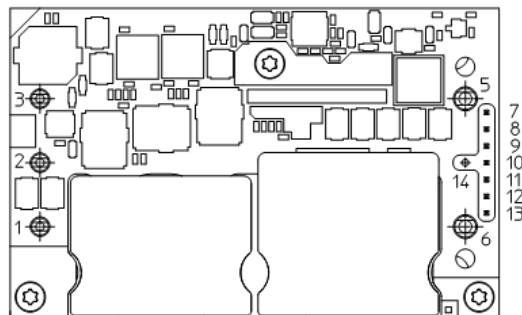

PIN SPECIFICATIONS:	
Pin 1-3, 5-6 Material:	Copper alloy
Plating:	Min Au 0.1 μm over Ni 1-3 μm
Pin 7-13 Material:	Brass
Plating:	Min Au 0.1 μm over Ni 1-3 μm
Pin 14	Not mounted (Option)

Pin	Designation	Function 7 pin
1	+In	Positive Input
2	RC	Remote Control
3	-In	Negative Input
5	-Out	Negative Output
6	+Out	Positive Output

Pin	Designation	Function 7 pin
7	PG/*CTRL	Power Good
8	SENSE-	Remote Sense-
9	SDA	PMBus Data
10	SALERT	PMBus alert signal
11	SCL	PMBus Clock
12	SA1	PMBus Address 1
13	SENSE+	Remote Sense+

*Pin 7 secondary remote control, set by hardware

Part 4: Thermal considerations

Thermal considerations

The products are designed to operate in different thermal environments and sufficient cooling must be provided to ensure reliable operation.

General

For products mounted on a PWB without a heatsink attached, cooling is achieved mainly by conduction, from the pins to the host board, and convection, which is dependent on the airflow across the product. Increased airflow enhances the cooling of the product. The wind speed and temperature are measured in a point upstream the device. The *output current derating graphs* found later in this section for each model provide the available output current vs. ambient air temperature and air velocity at $V_{in} = 49\text{ V}$.

For products using any form of heatsink structure a top spacing board and side airflow guides are used to ensure airflow hitting the module and not diverted away.

Distance between the tested device and the top space board and the side airflow guides are $6.35\text{ mm} \pm 1\text{ mm}$.

The product is tested on a $185 \times 185\text{ mm}$, $105\text{ }\mu\text{m}$ (3 oz), 6-layer test board mounted vertically in a wind tunnel.

For products with baseplate used in a sealed box/cold wall application, cooling is achieved mainly by conduction through the cold wall. The product is tested in a sealed box test set up with ambient temperatures 85°C . See [Design Note 028](#) for further details.

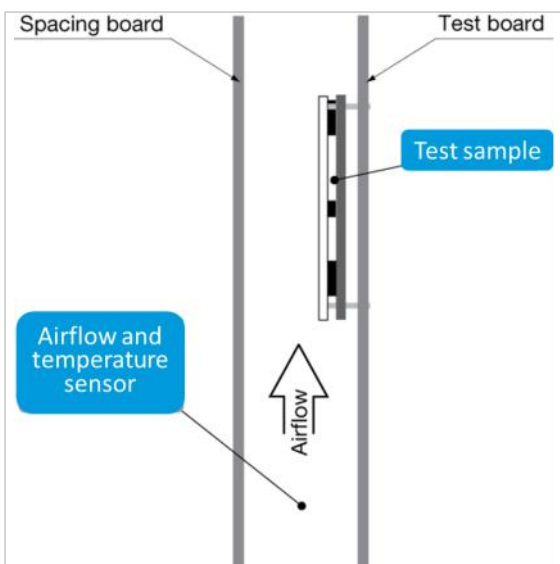

Picture: general test set-up

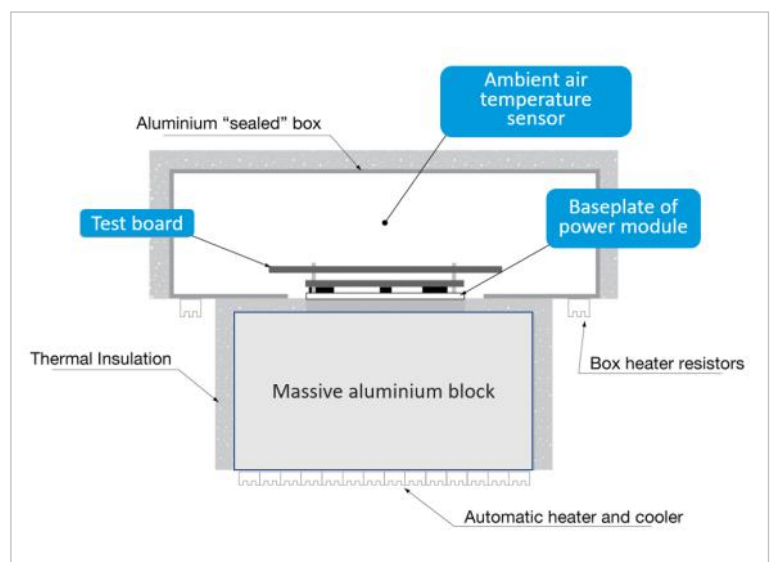

Picture: cold wall test set-up

Part 4: Thermal considerations

Definition of product operating temperature

Proper thermal conditions can be verified by measuring the temperature at position P1 as shown below. The temperature at this position (T_{P1}) should not exceed the maximum temperatures in the table below. The number of measurement points may vary with different thermal design and topology. Temperatures above maximum T_{P1} , measured at the reference point P1 are not allowed and may cause permanent damage.

Position	Description	Max. Temp.
P1	PWB reference point	$T_{P1} = 125^{\circ}\text{C}$

Bottom view

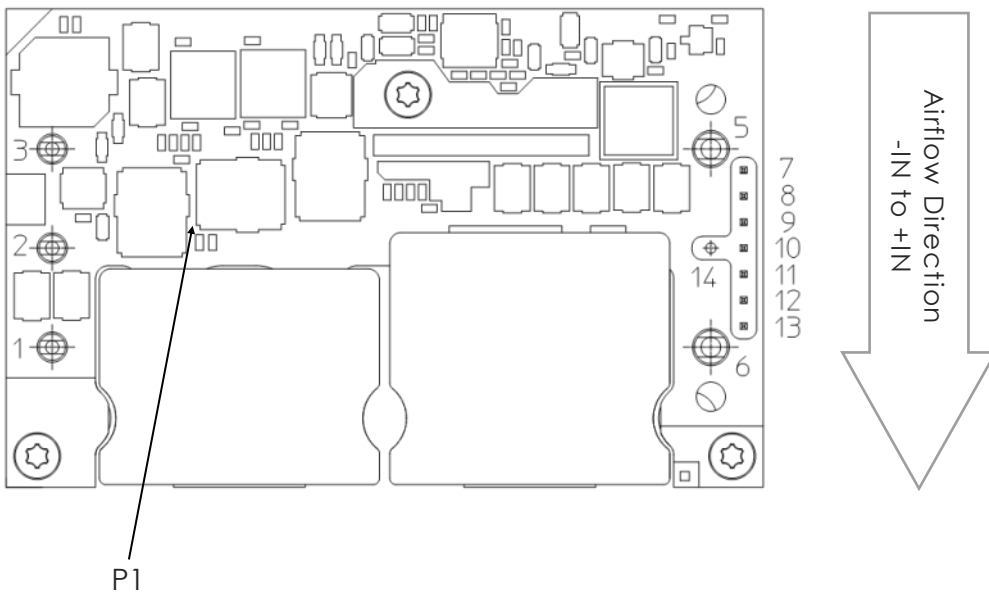

Thermal graphs

Output power derating - Baseplate

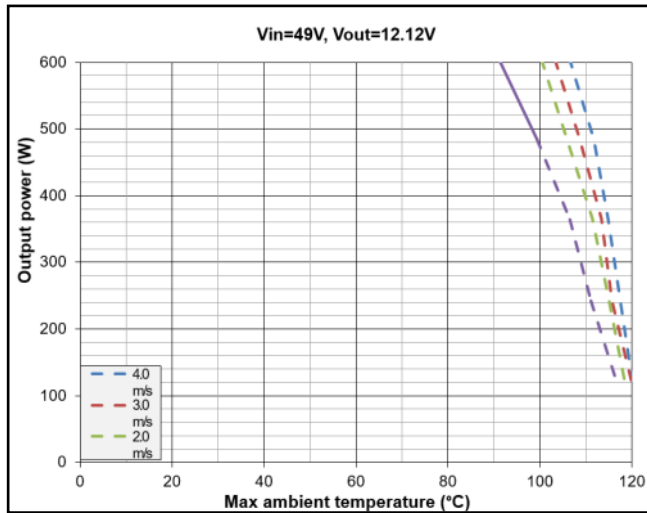

Available output power vs. ambient air temperature and airflow.
Airflow Direction -IN to +IN.

For more information, please refer to our [thermal models](#) on the website.

Part 5: Packaging
Packaging information

H option: Select for PIP reflow solder and pick & place - dry packed

Material	Antistatic Polyphenylene Ester (PPE)
Surface resistance	$\geq 1 \times 10^4$ to $< 1 \times 10^{11}$ ohms
Bakability	Tray can be baked at max. 125 °C for 24 h.
Tray thickness	25.0 mm 0.984 [inch]
Tray capacity	14 converters/tray
Box capacity	42 products (3 full trays/box)
Tray weight	214 g empty tray, 1305g full tray - closed deck baseplate.

JEDEC standard tray.
All dimensions in mm

Tolerances: X.x ± 0.26 [0.01], X.xx ± 0.13 [0.005]

Note: Pick up positions refer to center of pocket.

See [mechanical drawing](#) for exact location on product.

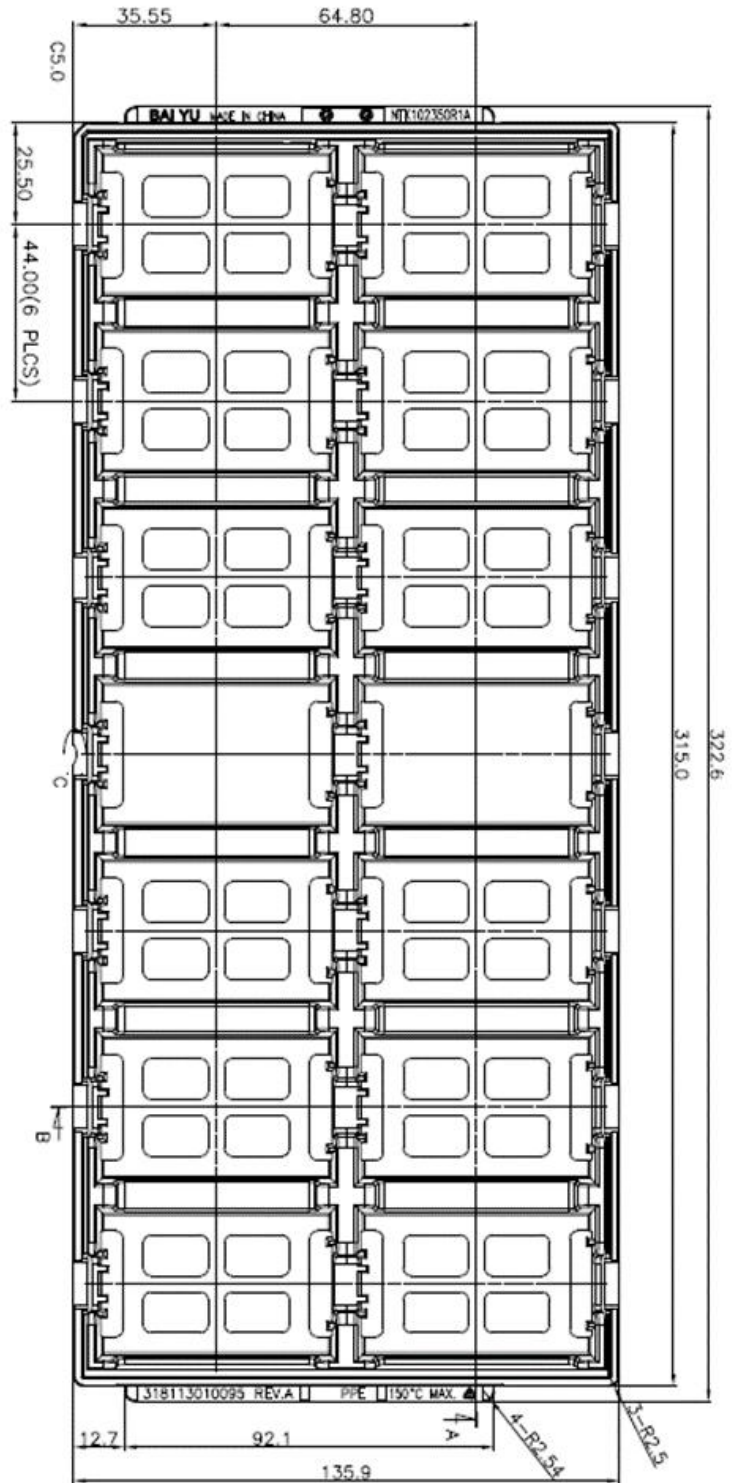

Example hard tray (14 pcs)

Packaging information

Blank option: Select for wave or hand soldering, NOT dry packed

Material	Antistatic Polyethylene (PE) foam
Surface resistance	$\geq 1 \times 10^4$ to $< 1 \times 10^{11}$ ohms
Bakability	Tray cannot be baked
Tray capacity	20 converters / tray
Box capacity	60 products (3 full trays/ box)
Weight	48 g empty tray, 1685 g full tray.

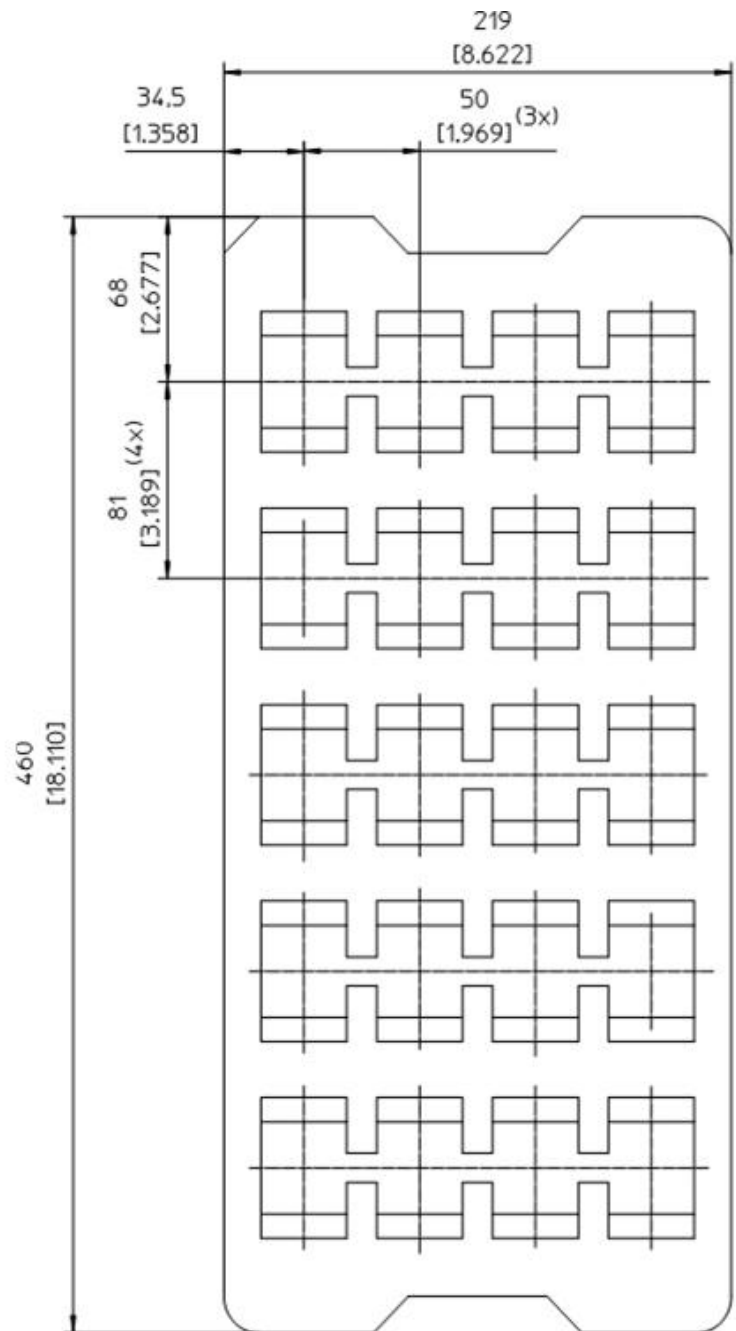

Example PE foam tray

Part 6: Revision history

Revision table

Revision number	revision change	date	revisor
Rev. A	New document	Aug 4th, 2022	jidmawan
Rev. C	Add product photo Add MTBF values Remove all TBDs	Aug 18th, 2022	jidmawan
Rev. D	Update product photo	Sep 28th, 2022	jidmawan
Rev. E	Update hardtray and packing weight Update the picture of Power Dissipation Add recommend capacitive load min and max value	Mar 09th, 2023 Mar 28th, 2023 Aug 11th, 2023	jidjesli jidfrawu jidfrawu
Rev. F	Minor changes	April 23th, 2026	kartwaer

©

Flex Power Modules 2026

The information and specifications in this technical specification is believed to be correct at the time of publication. However, no liability is accepted for inaccuracies, printing errors or for any consequences thereof. Flex reserves the right to change the contents of this technical specification at any time without prior notice.