

**PUC-2B series DC/DC Converters**  
Isolated 2W Unregulated Single/Dual Output

28701-BMR806 Rev. C

March 2023

© Flex

### Key Features

- Industry standard SIP-7 package  
19.7 x 7.1 x 11.5 mm (0.77 x 0.28 x 0.45 in)
- High efficiency, typ. 85% at 12 Vout full load
- 6000Vdc input to output isolation
- Reinforced insulation, rated for max. 300 Vrms working voltage
- Wide operating temperature from -40°C to 95°C
- No minimum load required
- Output short-circuit protection
- 5 V, 12 V & 24 V input
- 3.3 V, 5 V, 12 V & 15 V output
- MTBF 12.9 Mh

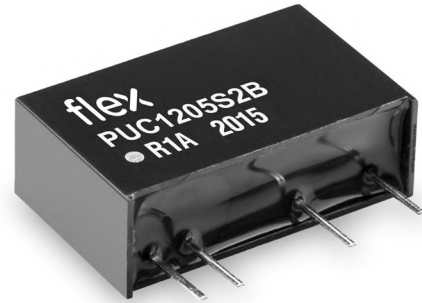

### General Characteristics

- 2W output power
- Safety Compliance to EN/UL 62368-1
- ISO 9001/14001 certified supplier

#### Safety Approvals



#### Design for Environment



Meets requirements in high-temperature lead-free soldering processes.

### Contents

|  |                       |
|--|-----------------------|
| Ordering Information                     | 2                     |
| General Information                      | 2                     |
| Safety Specification                     | 3                     |
| Absolute Maximum Ratings                 | 4                     |
|  |                       |
| Electrical Specification                 |                       |
| 5-24 Vi / 3.3-15 Vo, 0.067-0.606 A / 2 W | PUC-2B Series ..... 5 |
| EMC Specification                        | 10                    |
| Operating Information                    | 11                    |
| Thermal Consideration                    | 12                    |
| Connections                              | 12                    |
| Mechanical Information                   | 13                    |
| Soldering Information                    | 14                    |
| Delivery Information                     | 14                    |
| Product Qualification Specification      | 15                    |

## Technical Specification

**PUC-2B series DC/DC Converters**  
 Isolated 2W Unregulated Single/Dual Output

28701-BMR806 Rev. C

March 2023

© Flex

**Ordering Information**

| Product    | Nominal Input | Output               |
|------------|---------------|----------------------|
| PUC0503S2B | 5V            | 3.3 V, 0.606 A / 2 W |
| PUC0505S2B | 5V            | 5 V, 0.4 A / 2 W     |
| PUC0512S2B | 5V            | 12 V, 0.167 A / 2 W  |
| PUC0512D2B | 5V            | ±12 V, 0.084 A / 2 W |
| PUC1203S2B | 12V           | 3.3 V, 0.606 A / 2 W |
| PUC1205S2B | 12V           | 5 V, 0.4 A / 2 W     |
| PUC1212S2B | 12V           | 12 V, 0.167 A / 2 W  |
| PUC1205D2B | 12V           | ±5 V, 0.2 A / 2 W    |
| PUC1212D2B | 12V           | ±12 V, 0.084 A / 2 W |
| PUC2403S2B | 24V           | 3.3 V, 0.606 A / 2 W |
| PUC2405S2B | 24V           | 5 V, 0.4 A / 2 W     |
| PUC2412S2B | 24V           | 12 V, 0.167 A / 2 W  |
| PUC2405D2B | 24V           | ±5 V, 0.2 A / 2 W    |
| PUC2412D2B | 24V           | ±12 V, 0.084 A / 2 W |
| PUC2415D2B | 24V           | ±15 V, 0.067 A / 2 W |

**Product number and Packaging**

| PUCX <sub>1</sub> X <sub>2</sub> X <sub>3</sub> X <sub>4</sub> X <sub>5</sub> X <sub>6</sub> n <sub>1</sub> n <sub>2</sub> n <sub>3</sub> * |                |                |                |
|---|----------------|----------------|----------------|
| Options   | n <sub>1</sub> | n <sub>2</sub> | n <sub>3</sub> |
| Single/Dual output  | o              |                |                |
| Output Power  |                | o              |                |
| Form factor   |                |                | o              |

**Options****Description**

|                |   |               |
|----------------|---|---------------|
| n <sub>1</sub> | S | Single Output |
|                | D | Dual Output   |
| n <sub>2</sub> | 2 | 2W            |
| n <sub>3</sub> | B | SIP7          |

Example: a 24Vdc nominal input, single 5Vdc output, 2W SIP7 product would be PUC2405S2B.

\* X<sub>1</sub>X<sub>2</sub> = Nominal input voltage

X<sub>3</sub>X<sub>4</sub> = Output voltage (single/symmetric dual or asymmetric dual positive output)

X<sub>5</sub>X<sub>6</sub> = Negative output voltage (only for asymmetric dual)

**General Information****Reliability**

The failure rate ( $\lambda$ ) and mean time between failures (MTBF =  $1/\lambda$ ) is calculated at max output power and an operating ambient temperature ( $T_A$ ) of +25°C. Flex uses MIL-HDBK-217F, Notice 2 to calculate the mean steady-state failure rate.

In MIL-HDBK-217F, all part reliability models include the effects of environmental stresses through the environmental factor,  $\pi E$ . It encompasses the major areas of equipment use, here we use ground benign, GB.

| Mean steady-state failure rate, $\lambda$ | MTBF    |
|---|---------|
| 77.5 nFailures/h                          | 12.9 Mh |

**Compatibility with RoHS requirements**

The products are compatible with the relevant clauses and requirements of the RoHS directive 2011/65/EU and have a maximum concentration value of 0.1% by weight in homogeneous materials for lead, mercury, hexavalent chromium, PBB and PBDE and of 0.01% by weight in homogeneous materials for cadmium.

Exemptions in the RoHS directive utilized in Flex products are found in the Statement of Compliance document.

Flex fulfills and will continuously fulfill all its obligations under regulation (EC) No 1907/2006 concerning the registration, evaluation, authorization and restriction of chemicals (REACH) as they enter into force and is through product materials declarations preparing for the obligations to communicate information on substances in the products.

**Quality Statement**

The products are designed and manufactured in an industrial environment where quality systems and methods like ISO 9000, Six Sigma, and SPC are intensively in use to boost the continuous improvements strategy. Infant mortality or early failures in the products are screened out and they are subjected to an ATE-based final test. Conservative design rules, design reviews and product qualifications, plus the high competence of an engaged work force, contribute to the high quality of the products.

**Warranty**

Warranty period and conditions are defined in Flex General Terms and Conditions of Sale.

**Limitation of Liability**

Flex does not make any other warranties, expressed or implied including any warranty of merchantability or fitness for a particular purpose (including, but not limited to, use in life support applications, where malfunctions of product can cause injury to a person's health or life).

**© Flex 2023**

The information and specifications in this technical specification is believed to be correct at the time of publication. However, no liability is accepted for inaccuracies, printing errors or for any consequences thereof. Flex reserves the right to change the contents of this technical specification at any time without prior notice.

## Technical Specification

|   |                     |            |
|---|---------------------|------------|
| <b>PUC-2B series DC/DC Converters</b><br>Isolated 2W Unregulated Single/Dual Output | 28701-BMR806 Rev. C | March 2023 |
|   | © Flex              |            |

## Safety Specification

### General information

Flex Power DC/DC converters and DC/DC regulators are designed in accordance with the safety standards IEC 62368-1, EN 62368-1 and UL 62368-1 *Audio/video, information and communication technology equipment - Part 1: Safety requirements*

IEC/EN/UL 62368-1 contains requirements to prevent injury or damage due to the following hazards:

- Electrical shock
- Electrically-caused fire
- Injury caused by hazardous substances
- Mechanically-caused injury
- Skin burn
- Radiation-caused injury

On-board DC/DC converters, Power interface modules and DC/DC regulators are defined as component power supplies. As components they cannot fully comply with the provisions of any safety requirements without “conditions of acceptability”. Clearance between conductors and between conductive parts of the component power supply and conductors on the board in the final product must meet the applicable safety requirements. Certain conditions of acceptability apply for component power supplies with limited stand-off (see Mechanical Information for further information). It is the responsibility of the installer to ensure that the final product housing these components complies with the requirements of all applicable safety standards and regulations for the final product.

Component power supplies for general use shall comply with the requirements in IEC/EN/UL 62368-1. Product related standards, e.g. IEEE 802.3af *Power over Ethernet*, and ETS-300132-2 *Power interface at the input to telecom equipment, operated by direct current (dc)* are based on IEC/EN/UL 62368-1 with regards to safety.

Flex Power DC/DC converters, Power interface modules and DC/DC regulators are UL 62368-1 recognized and certified in accordance with EN 62368-1. The flammability rating for all construction parts of the products meet requirements for V-0 class material according to IEC 60695-11-10, *Fire hazard testing, test flames – 50 W horizontal and vertical flame test methods*.

### Isolated DC/DC converters & Power interface modules

The product may provide basic or functional insulation between input and output according to IEC/EN/UL 62368-1 (see Safety Certificate), different conditions shall be met if the output of a basic or a functional insulated product shall be considered as ES1 energy source.

For basic insulated products (see Safety Certificate) the output is considered as ES1 energy source if one of the

following conditions is met:

- The input source provides supplementary or double or reinforced insulation from the AC mains according to IEC/EN/UL 62368-1.
- The input source provides functional or basic insulation from the AC mains and the product’s output is reliably connected to protective earth according to IEC/EN/UL 62368-1.

For functional insulated products (see Safety Certificate) the output is considered as ES1 energy source if one of the following conditions is met:

- The input source provides double or reinforced insulation from the AC mains according to IEC/EN/UL 62368-1.
- The input source provides basic or supplementary insulation from the AC mains and the product’s output is reliably connected to protective earth according to IEC/EN/UL 62368-1.
- The input source is reliably connected to protective earth and provides basic or supplementary insulation according to IEC/EN/UL 62368-1 and the maximum input source voltage is 60 Vdc.

Galvanic isolation between input and output is verified in an electric strength test and the isolation voltage ( $V_{iso}$ ) meets the voltage strength requirement for basic insulation according to IEC/EN/UL 62368-1.

It is recommended to use a slow blow fuse at the input of each DC/DC converter. If an input filter is used in the circuit the fuse should be placed in front of the input filter. In the rare event of a component problem that imposes a short circuit on the input source, this fuse will provide the following functions:

- Isolate the fault from the input power source so as not to affect the operation of other parts of the system
- Protect the distribution wiring from excessive current and power loss thus preventing hazardous overheating

### Non - isolated DC/DC regulators

The DC/DC regulator output is ES1 energy source if the input source meets the requirements for ES1 according to IEC/EN/UL 62368-1.

Technical Specification

|   |                     |            |
|---|---------------------|------------|
| <b>PUC-2B series DC/DC Converters</b><br>Isolated 2W Unregulated Single/Dual Output | 28701-BMR806 Rev. C | March 2023 |
|   | © Flex              |            |

**Absolute Maximum Ratings**

| Characteristics |   | min | typ | max  | Unit |
|-----------------|---|-----|-----|------|------|
| $T_{P1}$        | Operating Temperature (see Thermal Consideration section)   | -40 |     | +95  | °C   |
| $T_{CASE}$      | Max. case temperature                                       |     |     | +105 | °C   |
| $T_S$           | Storage temperature   | -55 |     | +125 | °C   |
| $V_I$           | Input voltage Range (base on nominal input voltage)         | -10 |     | +10  | %    |
| $V_{iso}$       | Isolation voltage (input to output test voltage in 1minute) |     |     | 6000 | Vdc  |

Stresses above those listed under Absolute Maximum Ratings may cause permanent damage to the device. This is a stress rating only; functional operation of the device at these or any other conditions above those indicated in the Electrical Specification section of this specification is not implied. Exposure to absolute maximum rating conditions for extended periods may affect device reliability.

**Fundamental Circuit Diagram**

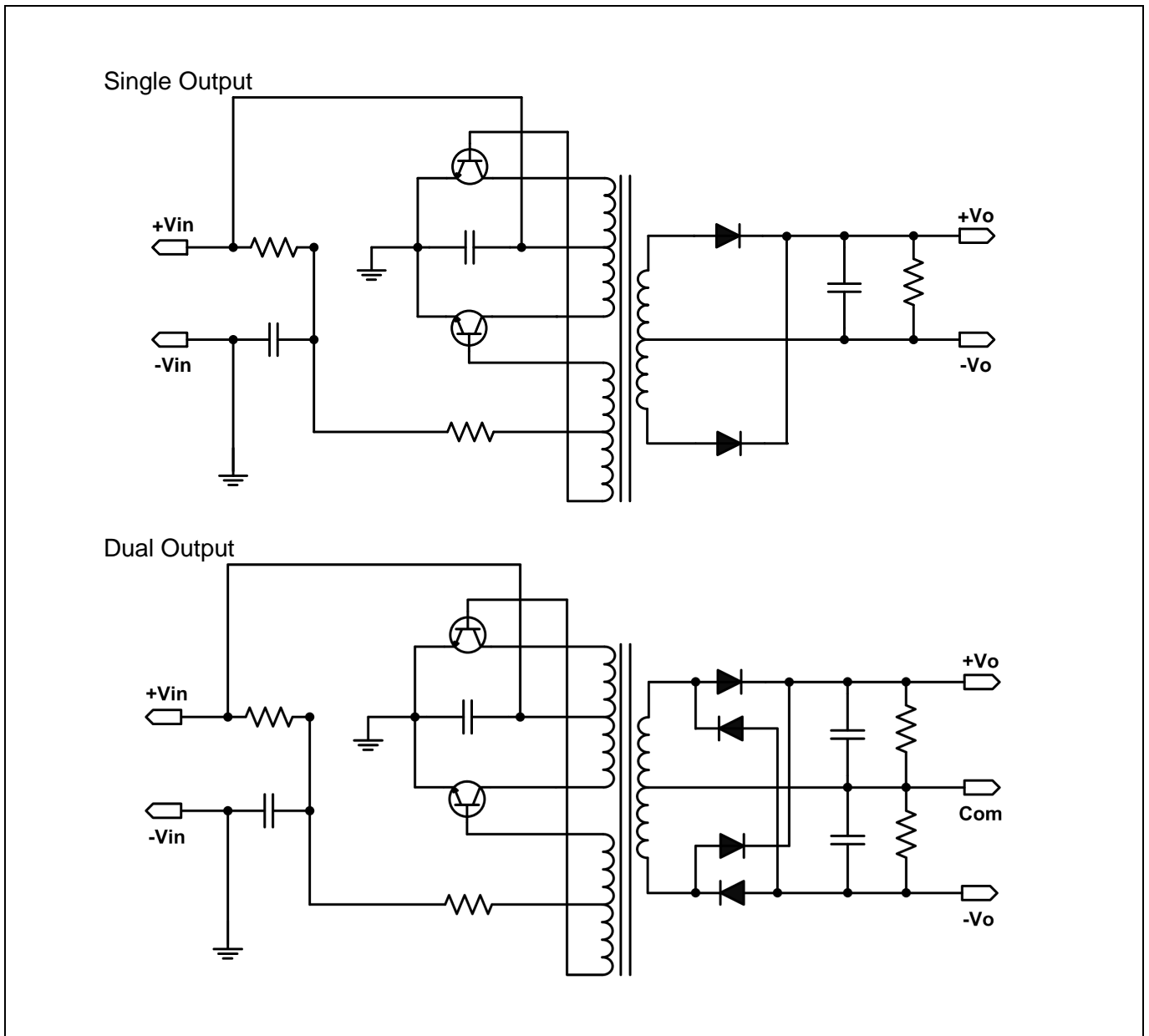

## Technical Specification

|   |                     |            |
|---|---------------------|------------|
| <b>PUC-2B series DC/DC Converters</b><br>Isolated 2W Unregulated Single/Dual Output | 28701-BMR806 Rev. C | March 2023 |
|   | © Flex              |            |

## Electrical Specification

## PUC-2B series

Typical values given at:  $T_{P1} = +25^{\circ}\text{C}$ , unless otherwise specified under Conditions.

| Part Number | Input Voltage<br>( $\pm 10\%$ ) | Output Voltage | Output Current | Efficiency (typ.)<br>50% of max $I_o$ | Efficiency (typ.)<br>max $I_o$ | Capacitive Load (note 1) |
|-------------|---------------------------------|----------------|----------------|---------------------------------------|--------------------------------|--------------------------|
|             | V                               | V              | A              | %                                     | %                              | $\mu\text{F}$            |
| PUC0503S2B  | 5                               | 3.3            | 0.606          | 74                                    | 77                             | 1000                     |
| PUC0505S2B  | 5                               | 5              | 0.4            | 76                                    | 79                             | 1000                     |
| PUC0512S2B  | 5                               | 12             | 0.167          | 77                                    | 83                             | 330                      |
| PUC0512D2B  | 5                               | $\pm 12$       | 0.084          | 77                                    | 82                             | 150                      |
| PUC1203S2B  | 12                              | 3.3            | 0.606          | 70                                    | 77                             | 1000                     |
| PUC1205S2B  | 12                              | 5              | 0.4            | 70                                    | 80                             | 1000                     |
| PUC1212S2B  | 12                              | 12             | 0.167          | 75                                    | 84                             | 330                      |
| PUC1205D2B  | 12                              | $\pm 5$        | 0.2            | 73                                    | 82                             | 680                      |
| PUC1212D2B  | 12                              | $\pm 12$       | 0.084          | 73                                    | 83                             | 150                      |
| PUC2403S2B  | 24                              | 3.3            | 0.606          | 73                                    | 79                             | 1000                     |
| PUC2405S2B  | 24                              | 5              | 0.4            | 73                                    | 81                             | 1000                     |
| PUC2412S2B  | 24                              | 12             | 0.167          | 75                                    | 85                             | 330                      |
| PUC2405D2B  | 24                              | $\pm 5$        | 0.2            | 73                                    | 82                             | 680                      |
| PUC2412D2B  | 24                              | $\pm 12$       | 0.084          | 75                                    | 85                             | 150                      |
| PUC2415D2B  | 24                              | $\pm 15$       | 0.067          | 74                                    | 84                             | 150                      |

| Characteristics |   | Conditions   | min | typ | max      | Unit             |
|-----------------|---|--|-----|-----|----------|------------------|
| $C_i$           | Internal input capacitance                              |  |     | 1   |          | $\mu\text{F}$    |
| $P_o$           | Output power  |  |     |     | 2        | W                |
| $C_{ISO}$       | Isolation capacitance                                   |  |     | 25  |          | pF               |
| $R_{ISO}$       | Isolation resistance                                    |  | 10  |     |          | $\text{G}\Omega$ |
| $V_{oi}$        | Voltage accuracy  | $T_{P1} = +25^{\circ}\text{C}$ , $I_o = \text{max } I_o$ | -5  |     | +5       | %                |
|                 | Minimum load  | $T_{P1} = +25^{\circ}\text{C}$                           | 0   |     |          | %                |
|                 | Line regulation   | $V_{LL}$ to $V_{HL}$ , max $I_o$                         |     | 1.2 |          | %                |
|                 | Load regulation<br>$I_{LL} - I_{HL}$ , at typ. $V_{in}$ | $V_o = 3.3 / 5 \text{ V}$<br>$V_o = 12 - 15 \text{ V}$   |     |     | 15<br>10 | %                |
| $f_s$           | Switching frequency                                     | 100 % of max $I_o$ (at Nominal $V_{in}$ )                | 20  |     |          | kHz              |
| $V_{Oac}$       | Output ripple & noise                                   | 20 MHz bandwidth limit, see Note 2                       |     |     | 100      | mVp-p            |

Note 1: The maximum capacitive load is test by normal input and constant resistive load.

Note 2: The Output ripple & noise is under nominal  $V_{in}$  and max  $I_o$  with 0.1  $\mu\text{F}/50\text{V}$  MLCC

Technical Specification

**PUC-2B series DC/DC Converters**  
Isolated 2W Unregulated Single/Dual Output

28701-BMR806 Rev. C

March 2023

© Flex

**Typical Characteristics**

**Efficiency**

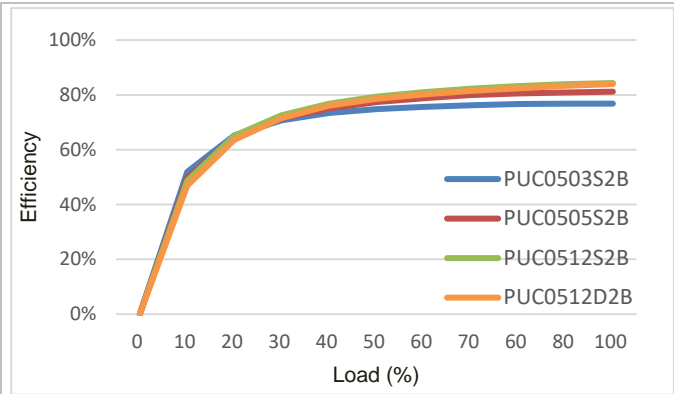

PUC05-2B  
Efficiency vs. load current at  $T_{P1} = +25^{\circ}\text{C}$ .

**PUC-2B series**

**Efficiency**

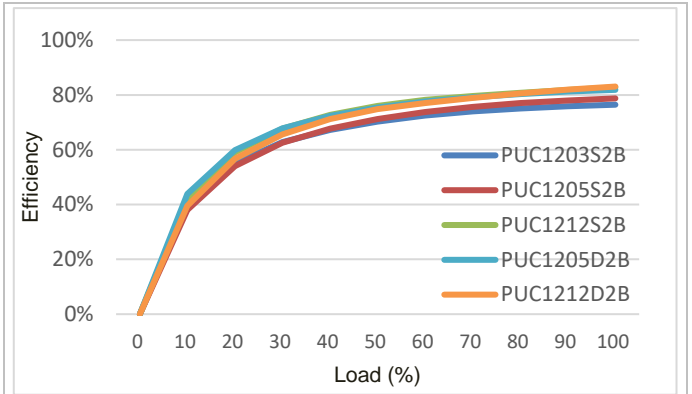

PUC12-2B  
Efficiency vs. load current at  $T_{P1} = +25^{\circ}\text{C}$ .

**Efficiency**

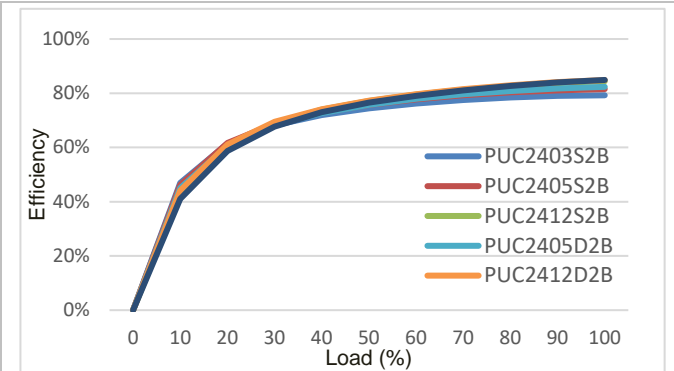

PUC24-2B  
Efficiency vs. load current at  $T_{P1} = +25^{\circ}\text{C}$ .

**Operating Ambient Temperature Curve**

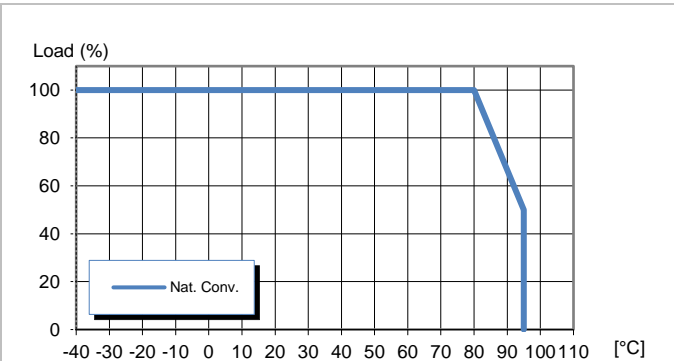

Available load vs. ambient air temperature.  
See Thermal Consideration section.  
(others)

**Operating Ambient Temperature Curve**

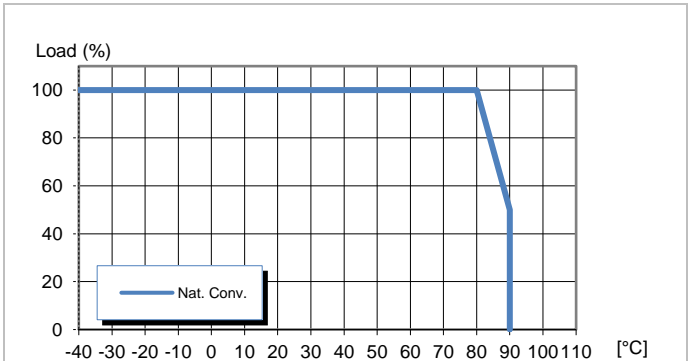

Available load vs. ambient air temperature.  
See Thermal Consideration section.  
(PUC1212S2B and PUC1212D2B)

Technical Specification

**PUC-2B series DC/DC Converters**  
Isolated 2W Unregulated Single/Dual Output

28701-BMR806 Rev. C

March 2023

© Flex

**Typical Characteristics**

**Output Voltage Accuracy**

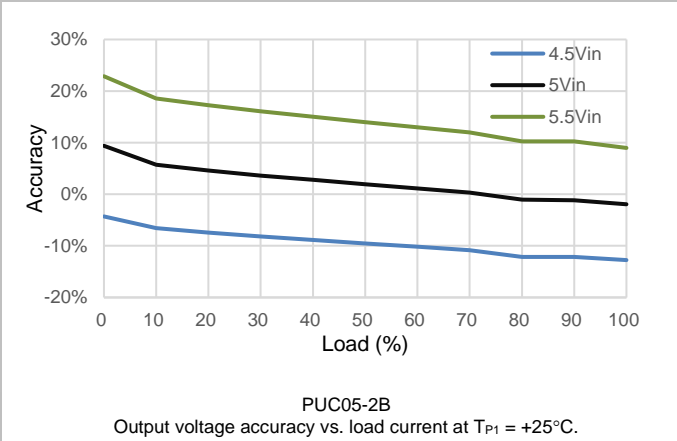

**PUC-2B series**

**Output Voltage Accuracy**

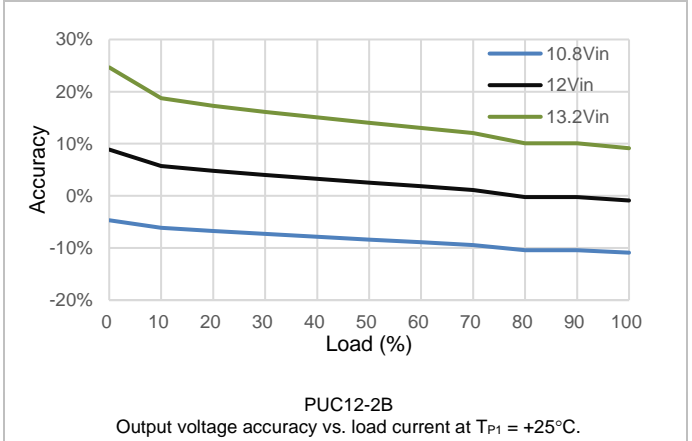

**Output Voltage Accuracy**

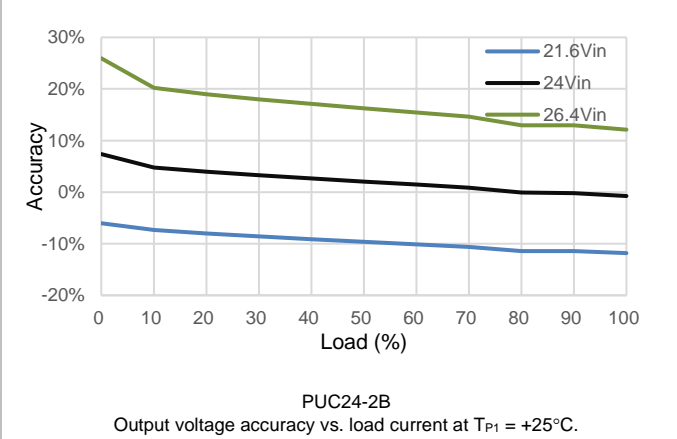

**Load Regulation**

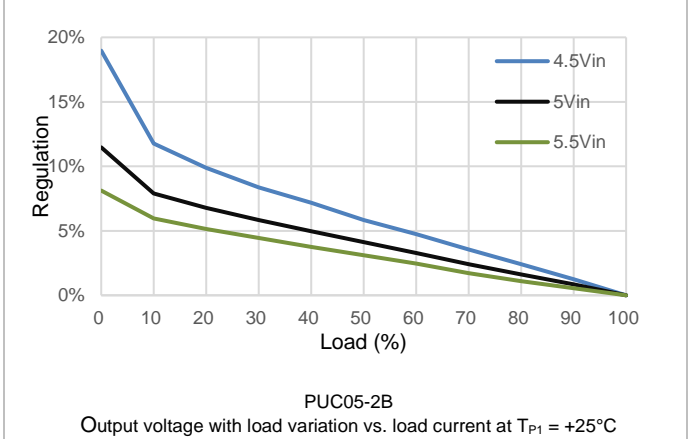

**Load Regulation**

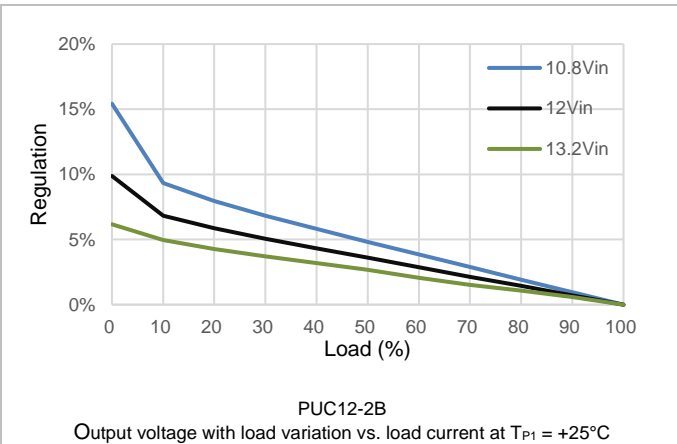

**Load Regulation**

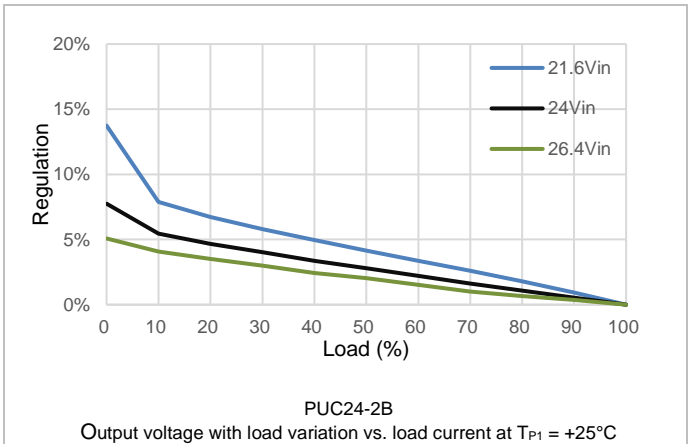

**PUC-2B series DC/DC Converters**  
Isolated 2W Unregulated Single/Dual Output

28701-BMR806 Rev. C

March 2023

© Flex

**Typical Characteristics**

**Output Ripple & Noise**

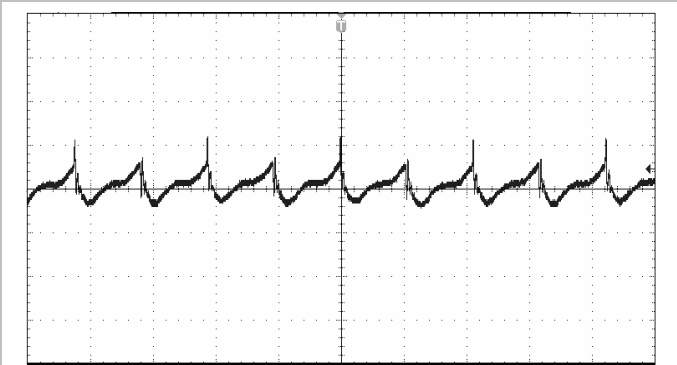

Output voltage ripple at:  
 $T_{P1} = +25^{\circ}\text{C}$ ,  $V_i = 5\text{ V}$ ,  $V_o = 5\text{ V}$   
 $I_o = 400\text{ mA}$  resistive load.

Trace: output voltage (50 mV/div.).  
Time scale: (10  $\mu\text{s}$ /div.).  
20 MHz bandwidth filter +0.1  $\mu\text{F}$

**PUC-2B series**

**Output Ripple & Noise**

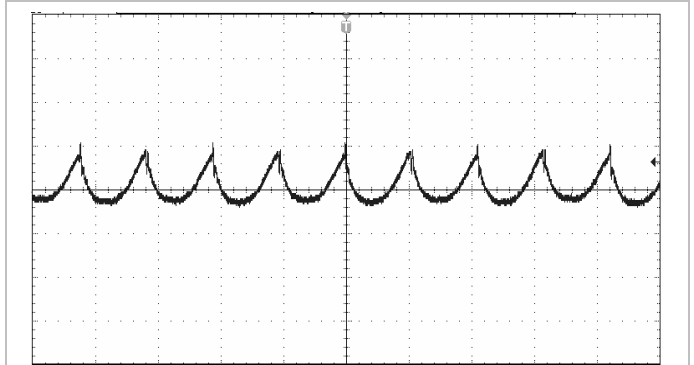

Output voltage ripple at:  
 $T_{P1} = +25^{\circ}\text{C}$ ,  $V_i = 12\text{ V}$ ,  $V_o = 5\text{ V}$   
 $I_o = 400\text{ mA}$  resistive load.

Trace: output voltage (50 mV/div.).  
Time scale: (10  $\mu\text{s}$ /div.).  
20 MHz bandwidth filter +0.1  $\mu\text{F}$

**Output Ripple & Noise**

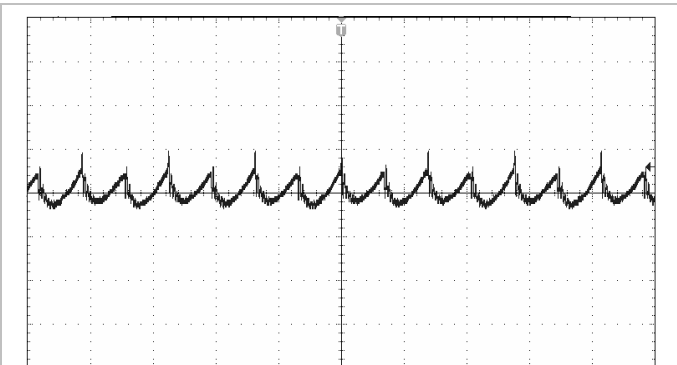

Output voltage ripple at:  
 $T_{P1} = +25^{\circ}\text{C}$ ,  $V_i = 24\text{ V}$ ,  $V_o = 5\text{ V}$   
 $I_o = 400\text{ mA}$  resistive load.

Trace: output voltage (50 mV/div.).  
Time scale: (10  $\mu\text{s}$ /div.).  
20 MHz bandwidth filter +0.1  $\mu\text{F}$

**Start-up**

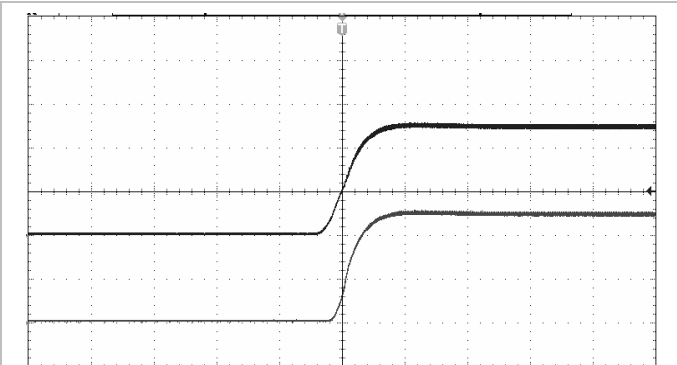

Start-up, enabled by connecting  $V_i$  at:  
 $T_{P1} = +25^{\circ}\text{C}$ ,  $V_i = 5\text{ V}$ ,  $V_o = 5\text{ V}$   
 $I_o = 400\text{ mA}$  resistive load.

Top trace: Input voltage (2 V/div.).  
Bottom trace: - Output voltage (2 V/div.).  
Time scale: (1 ms/div.).

**Shut-down**

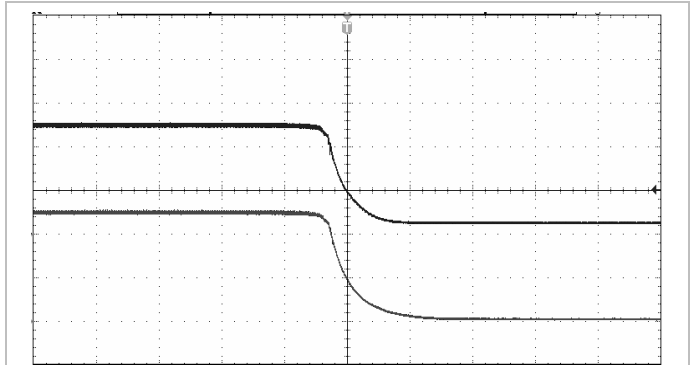

Shut-down, closed by disconnecting  $V_i$  at:  
 $T_{P1} = +25^{\circ}\text{C}$ ,  $V_i = 5\text{ V}$ ,  $V_o = 5\text{ V}$   
 $I_o = 400\text{ mA}$  resistive load.

Top trace: Input voltage (2 V/div.).  
Bottom trace: - Output voltage (2 V/div.).  
Time scale: (2 ms/div.).

**PUC-2B series DC/DC Converters**  
Isolated 2W Unregulated Single/Dual Output

28701-BMR806 Rev. C

March 2023

© Flex

**Typical Characteristics**

**PUC-2B series**

**Start-up**

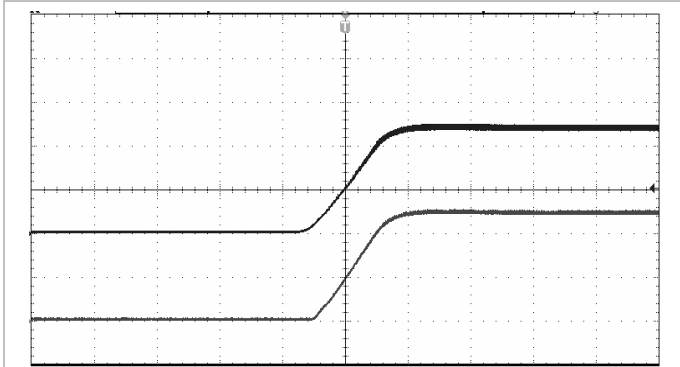

Start-up, enabled by connecting  $V_I$  at:  
 $T_{P1} = +25^\circ\text{C}$ ,  $V_I = 12\text{ V}$ ,  $V_O = 5\text{ V}$   
 $I_O = 400\text{ mA}$  resistive load.

Top trace: Input voltage (5 V/div.).  
Bottom trace: Output voltage (2 V/div.).  
Time scale: (1 ms/div.).

**Shut-down**

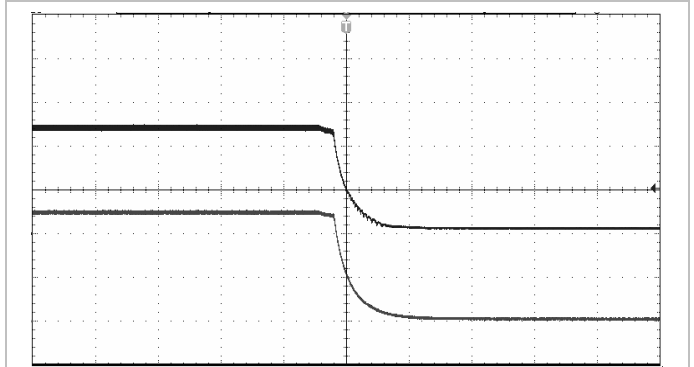

Shut-down, closed by disconnecting  $V_I$  at:  
 $T_{P1} = +25^\circ\text{C}$ ,  $V_I = 12\text{ V}$ ,  $V_O = 5\text{ V}$   
 $I_O = 400\text{ mA}$  resistive load.

Top trace: Input voltage (5 V/div.).  
Bottom trace: Output voltage (2 V/div.).  
Time scale: (2 ms/div.).

**Start-up**

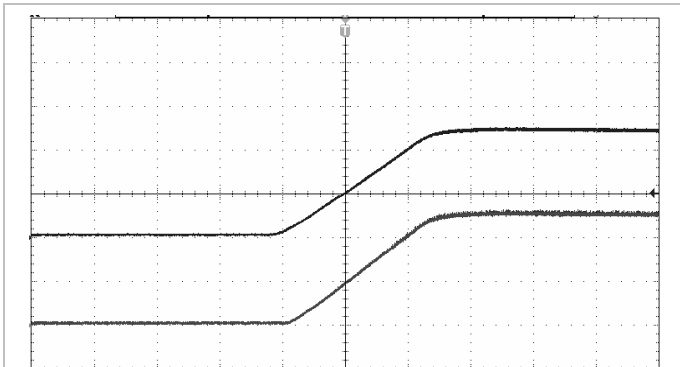

Start-up, enabled by connecting  $V_I$  at:  
 $T_{P1} = +25^\circ\text{C}$ ,  $V_I = 24\text{ V}$ ,  $V_O = 5\text{ V}$   
 $I_O = 400\text{ mA}$  resistive load.

Top trace: Input voltage (10 V/div.).  
Bottom trace: Output voltage (2 V/div.).  
Time scale: (1 ms/div.).

**Shut-down**

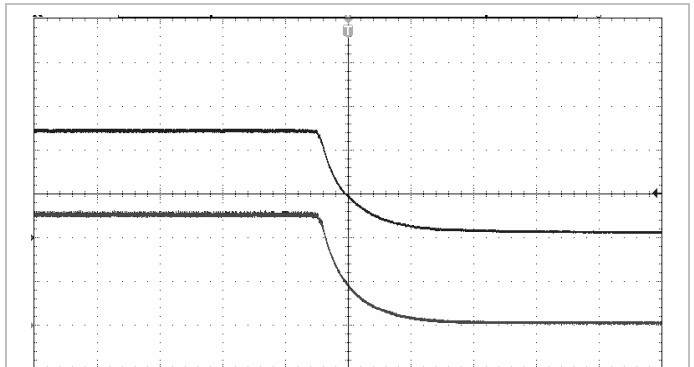

Shut-down, closed by disconnecting  $V_I$  at:  
 $T_{P1} = +25^\circ\text{C}$ ,  $V_I = 24\text{ V}$ ,  $V_O = 5\text{ V}$   
 $I_O = 400\text{ mA}$  resistive load.

Top trace: Input voltage (10 V/div.).  
Bottom trace: Output voltage (2 V/div.).  
Time scale: (2 ms/div.).

Technical Specification

**PUC-2B series DC/DC Converters**  
Isolated 2W Unregulated Single/Dual Output

28701-BMR806 Rev. C

March 2023

© Flex

**EMC Specification**

Conducted EMI measured according to EN55032, CISPR 32 and FCC part 15J (see test set-up). See Design Note 029 for further information. The minimum switching frequency is 20 kHz. The EMI characteristics below is measured at max I<sub>o</sub>.

**Optional external filter for class B**

Suggested external input filter in order to meet class B in EN 55032, CISPR 32 and FCC part 15J.

| Series   | L1    | C1   |
|----------|-------|------|
| PUC05-2B | 47μH  | 22μF |
| PUC12-2B | 47μH  | 10μF |
| PUC24-2B | 100μH | 22μF |

Based on different applications or PCB layout conditions, the EMI requirement may be varied. Recommend to reserve Cy1 for better EMI performance. Depending on the different requirement of end users, the value of Cy1 could be adjusted from 33pF to 470pF.

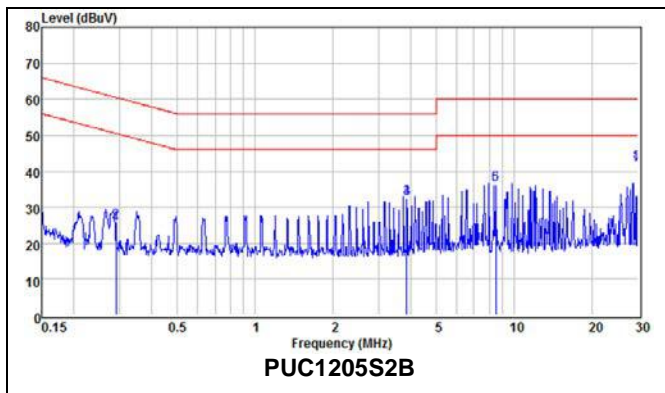

EMI with filter

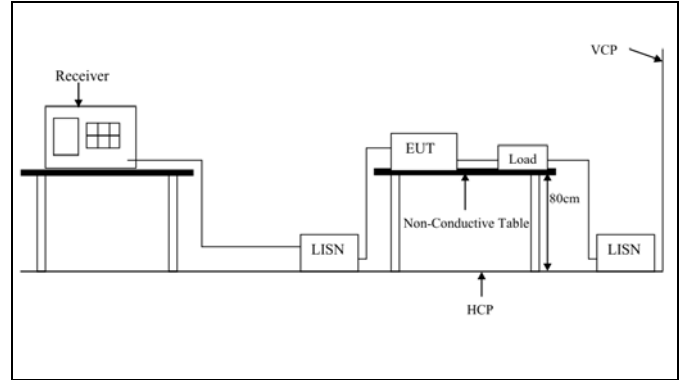

Test set-up

**Layout recommendations**

The radiated EMI performance of the product will depend on the PWB layout and ground layer design. It is also important to consider the stand-off of the product. If a ground layer is used, it should be connected to the output of the product and to the equipment ground or chassis.

A ground layer will increase the stray capacitance in the PWB and improve the high frequency EMC performance.

**Output ripple and noise**

Output ripple and noise is measured according to figure below. See Design Note 022 for detailed information.

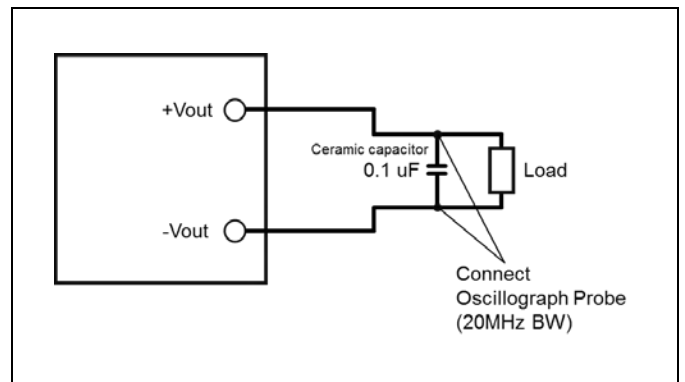

Output ripple and noise test setup

## Technical Specification

|   |                     |            |
|---|---------------------|------------|
| <b>PUC-2B series DC/DC Converters</b><br>Isolated 2W Unregulated Single/Dual Output | 28701-BMR806 Rev. C | March 2023 |
|   | © Flex              |            |

**Operating Information****Input Voltage**

Converter with 10% input voltage range, mainly for isolated power in industrial applications. For example, the input voltage range 4.5 to 5.5 Vdc meets requirement of general industrial used for 5Vdc system.

The input voltage should never exceed the absolute voltage of the converter, and the ambient temperature must be limited to absolute max +95°C.

The output voltage related to input voltage. Take 5Vin and 5Vo product as an example, if input voltage above 5V, the output voltage will higher than 5V. Below 5V and the output voltage starts to track the input voltage.

Short duration transient disturbances can occur on the DC distribution and input of the product when a short circuit fault occurs on the equipment side of a protective device (fuse or circuit breaker). The voltage level, duration and energy of the disturbance are dependent on the particular DC distribution network characteristics and can be sufficient to damage the product unless measures are taken to suppress or absorb this energy. The transient voltage can be limited by capacitors and other energy absorbing devices like Zener diodes connected across the positive and negative input conductors at a number of strategic points in the distribution network. The end-user must secure that the transient voltage will not exceed the value stated in the Absolute maximum ratings. ETSI TR 100 283 examines the parameters of DC distribution networks and provides guidelines for controlling the transient and reduce its harmful effect.

**Turn-off Input Voltage**

The products do not have under voltage lock-out function. Please make sure the input voltage of each module is correct working range.

**Input and Output Impedance**

The impedance of both the input source and the load will interact with the impedance of the product. It is important that the input source has low characteristic impedance. The product are designed for stable operation without external capacitors. With a 10 $\mu$ F capacitors connected to the input could reduce the input noise cause by parasitic inductance.

**External Decoupling Capacitors**

When powering loads with significant dynamic current requirements, the voltage regulation at the load can be improved by addition of decoupling capacitors at the load. The most effective technique is to locate low ESR ceramic and electrolytic capacitors as close to the load as possible, using several parallel capacitors to lower the effective ESR. The ceramic capacitors will handle high-frequency dynamic load

changes while the electrolytic capacitors are used to handle low frequency dynamic load changes. It is equally important to use low resistance and low inductance PWB layouts and cabling.

External decoupling capacitors will become part of the product's control loop. The control loop is optimized for a wide range of external capacitance and the maximum and minimum recommended value that could be used without any additional analysis is found in the Electrical specification. The ESR of the capacitors is a very important parameter. Stable operation is guaranteed with a verified ESR value of >1 m $\Omega$  across the output connections.

For further information please contact your local Flex Power Modules representative.

**Parallel Operation**

This product is not designed for paralleling without using external current sharing circuits.

**Over Current Protection (OCP)**

The products include current limiting circuitry for protection at continuous overload. The OCP works in a hiccup mode and will make continuous attempts to start up and will resume normal operation automatically after removal of the over current condition. The load distribution should be designed for the specified maximum output short circuit current.

Technical Specification

**PUC-2B series DC/DC Converters**  
Isolated 2W Unregulated Single/Dual Output

28701-BMR806 Rev. C

March 2023

© Flex

**Thermal Consideration**

**General**

The products are designed to operate in different thermal environments and sufficient cooling must be provided to ensure reliable operation.

For products mounted on a PWB without a baseplate attached, cooling is achieved mainly by conduction, from the pins to the host board, and convection, which is dependant on the airflow across the product. Increased airflow enhances the cooling of the product. The Output Current Derating graph found in the Output section for each model provides the available output current vs. ambient air temperature and air velocity.

The product is tested on a 95 x 85 mm, 35 µm (1 oz), 2-layer test board mounted horizontally in a space with a volume of 300(L) x 300(W) x 200(H) mm.

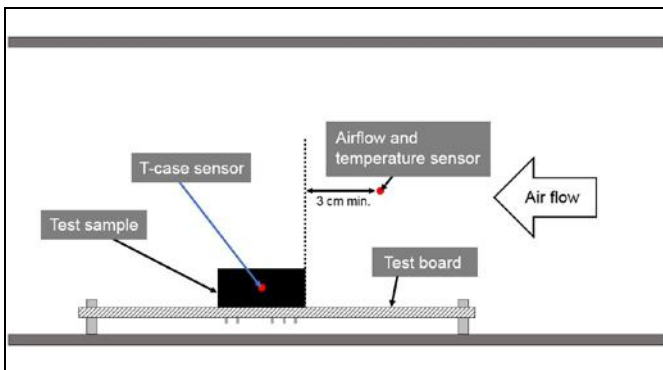

**Definition of product operating temperature**

The temperature at the positions P1 ( $T_{P1}$ ) should not exceed the maximum temperatures in the table below. The number of measurement points may vary with different thermal design and topology. Temperatures above maximum measured at the reference point P1 are not allowed and may cause permanent damage.

| Position | Description             | Max Temp.                    |
|----------|-------------------------|------------------------------|
| P1       | Driver, Reference point | $T_{P1}=105^{\circ}\text{C}$ |

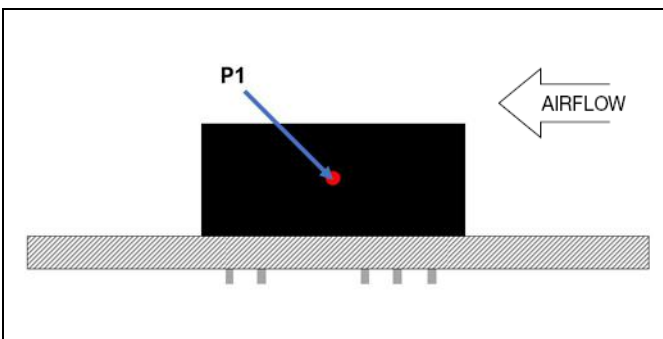

Pin side (baseplate module)

**Connections**

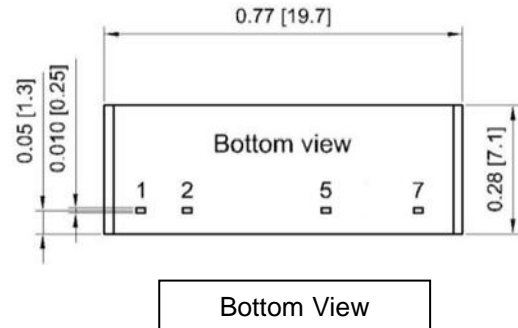

**PUCxxxxS2B single output series**

| Pin | Designation | Function        |
|-----|-------------|-----------------|
| 1   | +Vin        | Positive Input  |
| 2   | -Vin        | Negative Input  |
| 5   | -Vo         | Negative Output |
| 7   | +Vo         | Positive Output |

**Connections**

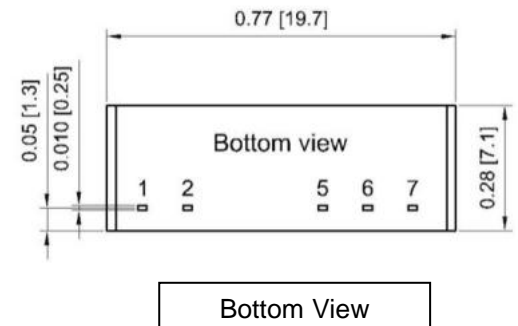

**PUCxxxxD2B dual output series**

| Pin | Designation | Function        |
|-----|-------------|-----------------|
| 1   | +Vin        | Positive Input  |
| 2   | -Vin        | Negative Input  |
| 5   | -Vo         | Negative Output |
| 6   | COM         | Common          |
| 7   | +Vo         | Positive Output |

Technical Specification

**PUC-2B series DC/DC Converters**  
Isolated 2W Unregulated Single/Dual Output

28701-BMR806 Rev. C

March 2023

© Flex

**Mechanical Information – Through Hole Mounting**

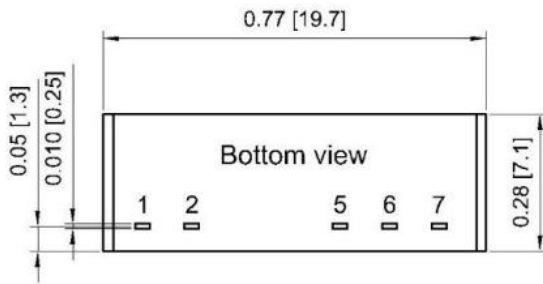
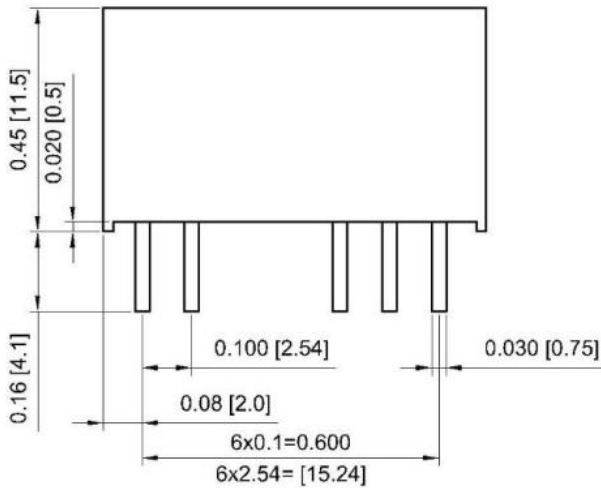

All Dimensions Inches(mm)

| Tolerance | Inches     | Millimeters |
|-----------|------------|-------------|
|           | X.XX±0.02  | X.X±0.5     |
|           | X.XXX±0.01 | X.XX±0.25   |
| PIN       | ±0.004     | ±0.1        |

**Recommended Footprint**

• Single

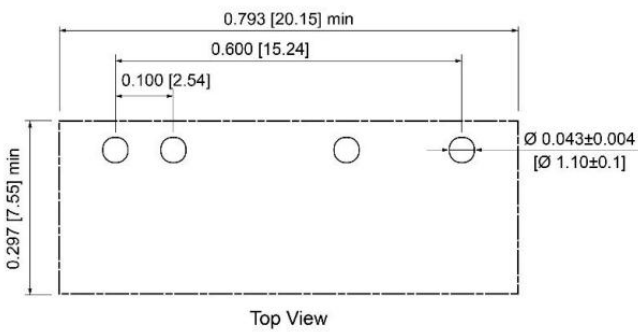

• Dual

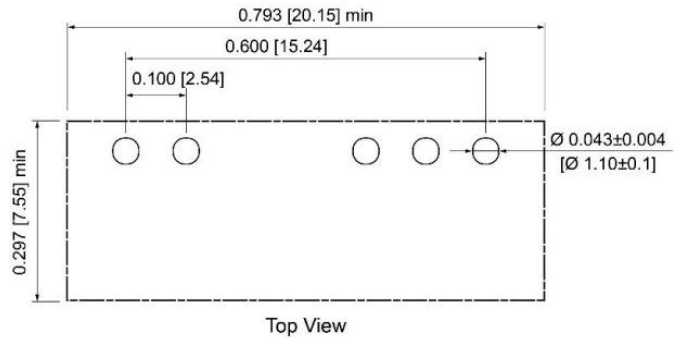

Technical Specification

|   |                     |            |
|---|---------------------|------------|
| <b>PUC-2B series DC/DC Converters</b><br>Isolated 2W Unregulated Single/Dual Output | 28701-BMR806 Rev. C | March 2023 |
|   | © Flex              |            |

**Soldering Information - Hole Mounting**

The hole mounted product is intended for plated through hole mounting by wave or manual soldering. The pin temperature is specified to maximum to 260°C for maximum 5 seconds.

A maximum preheat rate of 4°C/s and maximum preheat temperature of 150°C is suggested. When soldering by hand, care should be taken to avoid direct contact between the hot soldering iron tip and the pins for more than a few seconds in order to prevent overheating.

A no-clean flux is recommended to avoid entrapment of cleaning fluids in cavities inside the product or between the product and the host board. The cleaning residues may affect long time reliability and isolation voltage.

**Delivery Package Information**

The products are delivered in antistatic tube.

| Tube Specifications – SIP |                                      |
|---------------------------|--------------------------------------|
| <b>Material</b>           | Antistatic PS                        |
| <b>Surface resistance</b> | $10^5 < \text{Ohm/square} < 10^{12}$ |
| <b>Tube length</b>        | 520 mm 20.47 [ inch]                 |
| <b>Tube capacity</b>      | 24 products (30 full tubes/box)      |
| <b>Tube weight</b>        | 27.6 g empty, 100 g full tube        |
| <b>Module weight</b>      | 2.8 g / pc                           |

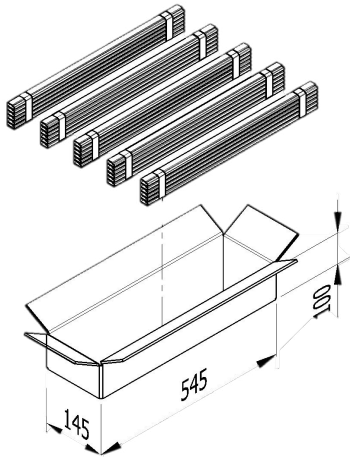

1BOX = 24 (pcs/tube) \* 6 (tube/bundle) \* 5 (bundle) = 720pcs  
 1BOX = 720 converters  
 All dimensions in mm  
 Note: pick up positions refer to center of pocket.  
 See mechanical drawing for exact location on product.

## Technical Specification

|   |                     |            |
|---|---------------------|------------|
| <b>PUC-2B series DC/DC Converters</b><br>Isolated 2W Unregulated Single/Dual Output | 28701-BMR806 Rev. C | March 2023 |
|   | © Flex              |            |

## Product Qualification Specification

| Characteristics                                |  |  |   |
|--|--|--|---|
| External visual inspection                     | IPC-A-610  |  |   |
| Change of temperature<br>(Temperature cycling) | MIL-STD-202G, method 107G                          | Temperature range<br>Number of cycles<br>Dwell/transfer time | -55 to 125°C<br>1000<br>30 min/0-1 min            |
| Cold (in operation)                            | IEC 60068-2-1 Ad                                   | Temperature T <sub>A</sub><br>Duration                       | -40°C<br>72 h                                     |
| Damp heat                                      | MIL-STD-202G, Method 103B                          | Temperature<br>Humidity<br>Duration                          | 85°C<br>95 % RH<br>1000 hours                     |
| Dry heat                                       | IEC 60068-2-2 Bd                                   | Temperature<br>Duration                                      | 125°C<br>1000 h                                   |
| Electrostatic discharge<br>susceptibility      | IEC 61000-4-2                                      | Air model<br>Contact model                                   | 15000 V<br>8000 V                                 |
| Mechanical shock                               | MIL-STD-202G, method 213B                          | Peak acceleration<br>Duration                                | 100 g<br>6 ms                                     |
| Operational life test                          | MIL-STD-202G, method 108A                          | Duration   | 1000 h  |
| Resistance to soldering heat <sup>1</sup>      | MIL-STD-202G, method 210F                          | Solder temperature<br>Duration                               | 260°C<br>10 s                                     |
| Robustness of terminations                     | IEC 60068-2-21 Test Ua1<br>IEC 60068-2-21 Test Ue1 | Through hole mount products<br>Surface mount products        | All leads<br>All leads                            |
| Solderability                                  | J-STD-002  | Preconditioning<br>Temperature, Pb-free                      | Steam ageing 8 h<br>245°C                         |
| Vibration                                      | MIL-STD-202G, method 201A                          | Frequency<br>Displacement<br>Duration                        | 10 to 55 Hz<br>0.06 inch<br>2 h in each direction |

## Notes

<sup>1</sup> Only for products intended for wave soldering (plated through hole products)