

BMR 350 2253/803

1300-1700 W digital quarter brick DC/DC IBC



The BMR350 2253/803 is the new generation of high-power digital DC/DC converter. The impressive performance of this converter includes an efficiency of 97.7% at 51V_{in} and half load.

The BMR350 2253/803 is a non-isolated quarter brick, and has a low building height of only 12 mm. The converter delivers a fully regulated 12.20 V. BMR350 2253/803 delivers a continuous power level of 1300 W and has a peak power capability of up to 1700 W for limited time.

This converter is designed for through-hole mounting using wave solder or pin-in-paste production, and incorporates a novel design of baseplate, which optimizes thermal performance while minimizing height.



Key features

- High efficiency with 97.7%
- Non-isolated
- 12.20V fully regulated
- Event data recorder (black-box)
- Parallel operation with DLS Current Sharing
- Screwed baseplate
- Monotonic start-up
- Output over voltage protection
- Over temperature protection
- Output short-circuit protection
- Remote control
- PMBus configuration

Soldering methods

- Reflow soldering Pin In Paste
- Wave soldering
- Manual soldering

Key electrical information

Parameter	Values
Input range	40-60 V
Output voltage	12.20V
Output current	108A
Peak current	140A
Output power	1300 W
Peak power	1700 W

Mechanical

58.4 x 36.8 x 12 mm / 2.30 x 1.45 x 0.47 in

Application areas

- Datacom applications

Product options

The table below describes the different product options.

Example: BMR350 2 2 53 /803						H	Definitions
Product family	BMR350						
Pin length options		2					0 = 5.33 mm / 0.21 in 2 = 3.69 mm / 0.15 in 3 = 4.57 mm / 0.18 in 4 = 2.79 mm / 0.11 in
Baseplate / HS option			2				2 = Baseplate top and bottom
Other hardware options				53			53 = 1300W with Sense function, 7-pin digital header
Configuration code					/803		/803=12.20 V _{out} , DLS current sharing
Packaging options						H	E = soft tray, dry pack (PIP reflow soldering) H = hard tray, dry pack (PIP reflow soldering) blank = foam tray (no dry pack, wave soldering)

For more information, please refer to Part 3 [Mechanical information](#).

If you do not find the variant you are looking for, please contact us at [Flex Power Modules](#).

Order number examples

Part number	V _{in}	Outputs	Configuration
BMR350 2253/803H	40-60 V	12.20V / 108A/ 1300W	3.69 mm pins / 7-pin digital header / base plate / sense /DLS /dry pack, hard tray

Electrical specifications for BMR350 2253/803**12.20V, 108A (140A) ≤ 1300W (1700W)**

Min and Max values are valid for: $T_{P1} = -30$ to $+90^{\circ}\text{C}$, $V_{in} = 40\text{V}$ to 60V , unless otherwise specified under conditions. Typical values given at: $T_{P1} = +25^{\circ}\text{C}$, $V_{in} = 51\text{V}$, max P_{out_TDP} , unless otherwise specified under conditions, see Note 1.

Additional external $C_{in} = 220\ \mu\text{F}$, $C_{out} = 1.5\ \text{mF}$

Characteristic	conditions	minimum	typical	maximum	unit
Key features					
Efficiency (η)	50% of P_{out_TDP}		97.7		%
	100% of P_{out_TDP}		96.9		%
P_{out_TDP} thermal design power (TDP)	See Note 1			1300	W
P_{out_MAX} peak power ($t \leq 200\text{ms}$)	See Note 1			1700	W
Power dissipation	100% of P_{out_TDP}		42.4	57.6	W
Switching frequency (f_s)	0-100 % of P_{out_TDP}	130	150	160	kHz
Recommend capacitive load		1500		20000	μF
Input characteristics					
Input voltage range (V_{in})		40		60	V
Input idling power	$P_{out} = 0\ \text{W}$		5.4	12.1	W
Input standby power	(turned off with RC)		552	768	mW
Input OVP			70		V
Internal input capacitance			90		μF
Recommended external input capacitance		220			μF

Note 1: Max. output current is rated at 140 A. Max power is $\leq 1700\ \text{W}$ and continuous power (thermal design power (TDP) is $\leq 1300\ \text{W}$ depending on thermal conditions.)

Part 1: Electrical specifications

Electrical specifications for BMR350 2253/803**12.2V, 108A (140A) ≤ 1300W (1700W)**

Min and Max values are valid for: $T_{P1} = -30$ to $+90^{\circ}\text{C}$, $V_{in} = 40\text{V}$ to 60V , unless otherwise specified under conditions. Typical values given at: $T_{P1} = +25^{\circ}\text{C}$, $V_{in} = 51\text{V}$, max P_{out_TDP} , unless otherwise specified under conditions, see Note 1.

Additional external $C_{in} = 220\ \mu\text{F}$, $C_{out} = 1.5\ \text{mF}$

Characteristic	conditions	minimum	typical	maximum	unit
Output characteristics					
Output voltage initial setting and accuracy	$P_{out} = 0\ \text{W}$	12.16	12.20	12.24	V
Output voltage tolerance band	0 – 100% of max P_{out_TDP} $V_{in} = 40\text{-}60\ \text{V}$	11.50		12.30	V
Output adjust range	0-100% of max P_{out_TDP}	8		13.2	V
Idling voltage	$P_{out} = 0\ \text{W}$, 51 V	12.05		12.35	V
Line regulation	$V_{in} = 40 - 60\ \text{V}$ 0 – 100% of max P_{out_TDP}		15		mV
Load regulation	0 - 100% of max P_{out_TDP}		550		mV
Output current (I_{out})	$V_{in} = 40 - 60\ \text{V}$	0		108	A
Load transient voltage deviation	Load step 25-75-25% of max P_{out_TDP} $di/dt = 1\ \text{A}/\mu\text{s}$. See Note 2		±400		mV
Load transient recovery time			200		μs
Output ripple & noise	max P_{out_TDP} See Note 3		50	160	mV_{p-p}

Note 1: Max. output current is rated at 140 A. Max power is $\leq 1700\ \text{W}$ and continuous power (thermal design power (TDP)) is $\leq 1300\ \text{W}$ depending on thermal conditions.

Note 2: C_{out} is 2x2.2mF

Note 3: See Technical Reference doc: Design considerations

Part 1: Electrical specifications

Electrical specifications for BMR3502253/803

12.20V, 108A (140A) ≤ 1300W (1700W)

Characteristic	conditions	minimum	typical	maximum	unit
On/off control					
Turn-off input voltage	Decreasing input voltage	34	35	37	V
Turn-on input voltage	Increasing input voltage	35	37	39	V
Ramp-up time (from 0–100% of V_{out})		7	10	13	ms
Start-up time (from V_{in} connection to 90% of V_{out})			40		ms
RC start-up time			25		ms
Logic high: trigger level			1.4		V
Logic low: trigger level			1.3		V
Logic low: response time		0.1	0.2	0.3	ms
Sink current		0.4			mA
Protection features					
Current limit threshold (OCP)	$T_{P1} < \max T_{P1}$	176	190	204	A
Output current limit (OCP) response time and type	latch		25		μs
Current limit threshold (Slow OCP)			130		A
Current limit Off Delay (Slow OCP)	Load step 108-140A.			200	ms
Output overvoltage protection (OVP)			14.2		V
Output overvoltage protection (OVP) response time and type	Disabled until fault cleared		70		μs
Over temperature protection (OTP)	See note 1		125		°C
Over temperature protection (OTP) re-start temperature and type	Disabled until fault cleared		90		°C

Note 1: Please attach thermocouple on NTC resistor to test OTP function, the hot spot (P1) temperature is just for reference.

Electrical specifications for BMR350 2253/803**12.20V, 108A (140A) ≤ 1300W (1700W)**

In the table below all PMBus are written in capital letters.

$T_{P1} = -30$ to $+90$ °C, $V_{in} = 40V$ to $60V$, unless otherwise specified under conditions.

Typical values given at: $T_{P1} = +25$ °C, $V_{in} = 51V$, max P_{out_TDP} , unless otherwise specified under conditions

Command	Conditions	minimum	typical	maximum	Unit
Monitoring accuracy					
Input voltage READ_VIN			±125		mV
Output voltage READ_VOUT			±40		mV
Output current READ_IOUT	$T_{P1} = 25$ °C, $V_O = 12$ V		±0.5		A
	$T_{P1} = -20-120$ °C, $V_O = 12$ V		±2.5		A
Duty cycle READ_DUTY_CYCLE	No tolerance, Read value is the actual value applied by PWM controller				
Temperature READ_TEMPERATURE_1	Temperature sensor		±5		°C

For more detailed information please refer to Technical Reference Document: PMBus commands.

This product is supported by the [Flex Power Designer tool](#).

Electrical graphs for BMR350 2253/803

12.20V, 108A (140A) ≤ 1300W (1700W)

Efficiency

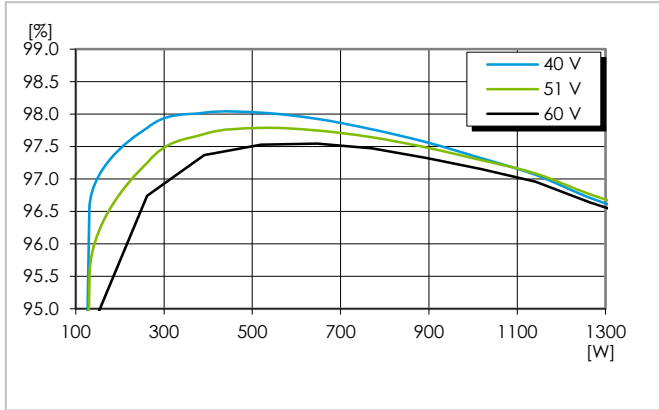

Efficiency vs. output power and input voltage at $T_{P1} = +25^{\circ}\text{C}$.

Power dissipation

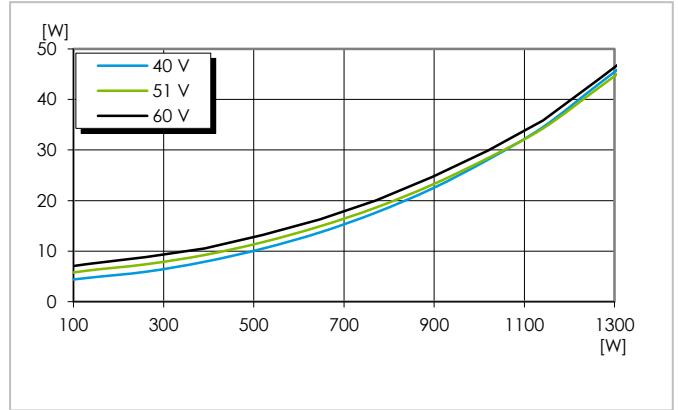

Dissipated power vs. load power at $T_{P1} = +25^{\circ}\text{C}$. Above P_{out_TDP} , 1300W only peak $t \leq 200\text{ms}$

Line regulation

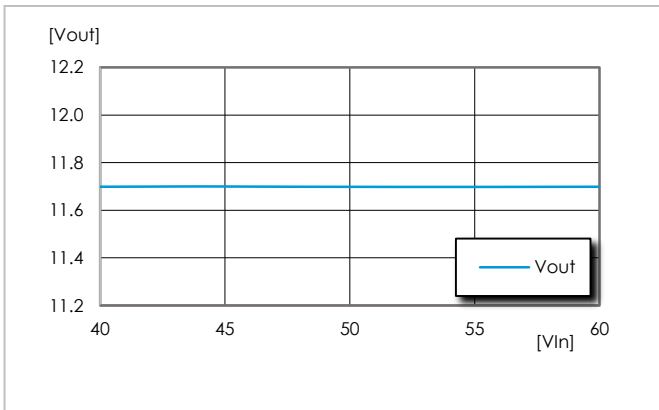

Output voltage vs. input voltage at $T_{P1} = +90^{\circ}\text{C}$, 100% of max P_{out_TDP} , 1300W.

Available power

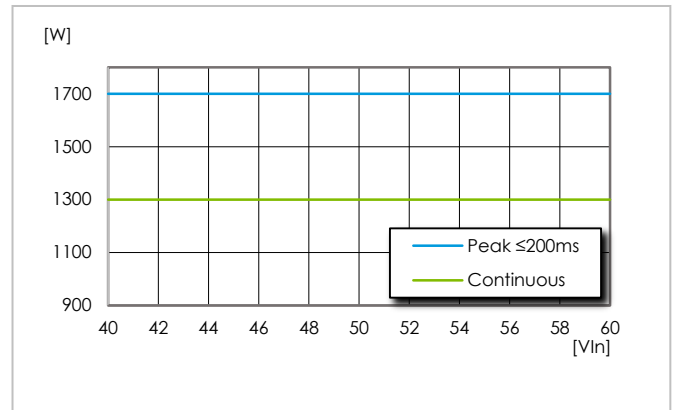

Available output power vs. input voltage, $T_{P1} = +90^{\circ}\text{C}$

Power loss at max temperature

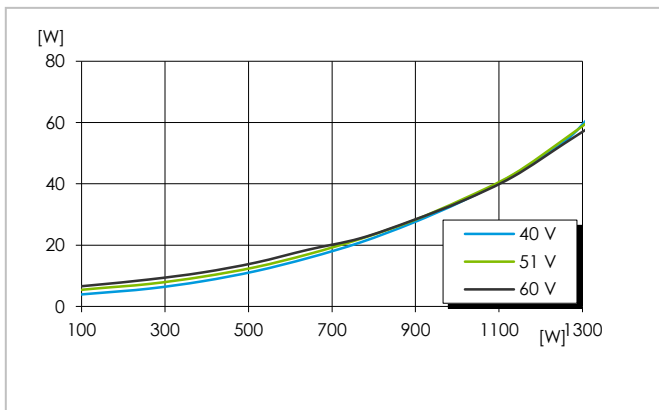

Dissipated power vs. output power and input voltage at $T_{P1} = +90^{\circ}\text{C}$. Above P_{out_TDP} , 1300W only peak $t \leq 200\text{ms}$

Output voltage adjust range

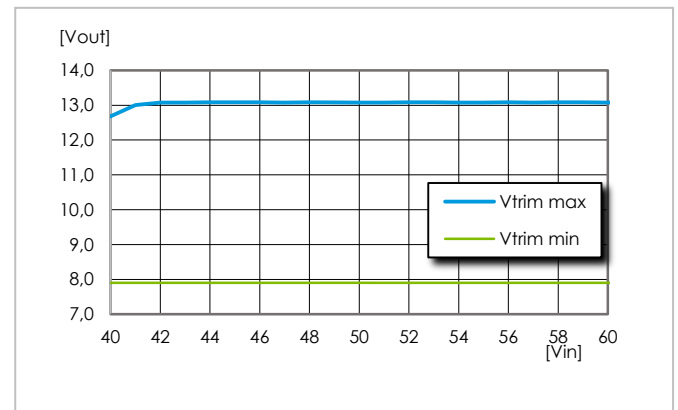

Max and min V_{out} trim vs V_{in} . At P_{out_TDP} , 1300W.

Part 2: EMC

EMC specifications

Conducted EMI measured according to EN55022 / EN55032, CISPR 22 / CISPR 32 and FCC part 15J (see test set-up below). The fundamental switching frequency is 150 kHz for BMR350. The EMI characteristics below is measured at $V_{in} = 51\text{ V}$ and max I_{out} .

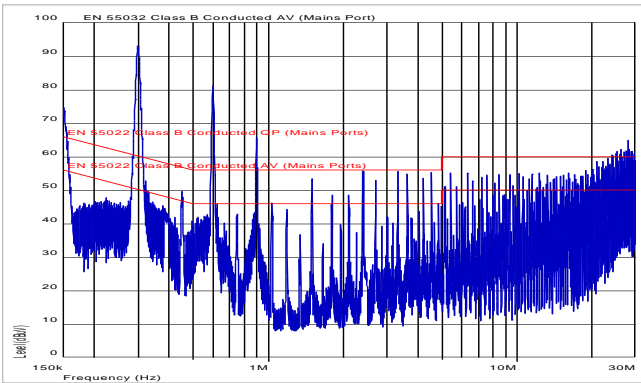

EMI without filter. EN55032 test method and limits are the same as EN55022. 1000 μF 100V input capacitor and 1mF + 470 μF 16 V OS-CON output capacitors used

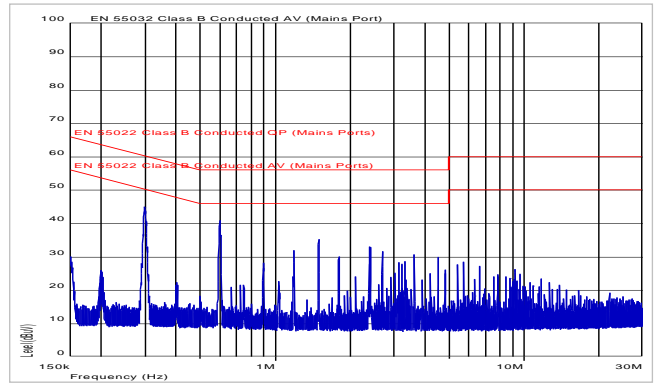

EMI with filter, EN55032 test methods and limits are the same as EN55022

Optional external filter for Class B

Suggested external input filter in order to meet Class B in EN 55022 / EN 55032, CISPR 22 / CISPR 32 and FCC part 15J.

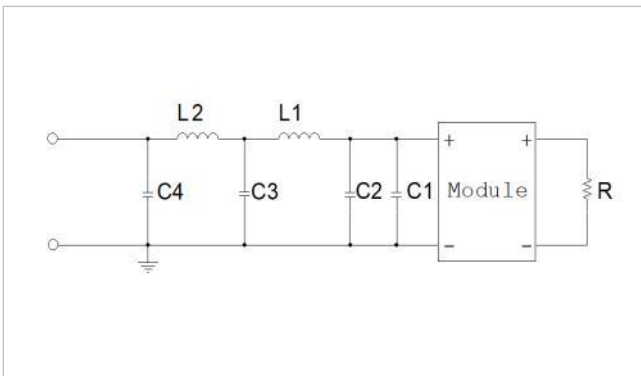

Filter components:
C1 = 1000 μF (e-lyt)
C2 = 2 x 2.2 μF
C3, C4 = 10 μF
L1, L2 = 4.7 μH

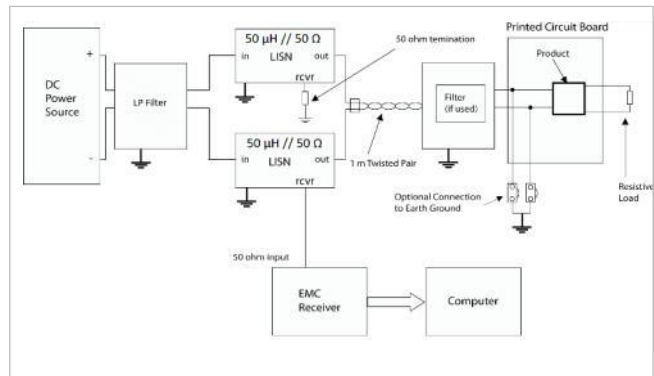

Test set-up

Layout recommendations

The radiated EMI performance of the product will depend on the PWB layout and ground layer design. It is also important to consider the stand-off of the product. If a ground layer is used, it should be connected to the output of the product and the equipment ground or chassis.

A ground layer will increase the stray capacitance in the PWB and improve the high frequency EMC performance.

Part 3: Mechanical information
BMR350 2253/803: hole mounted, baseplate version

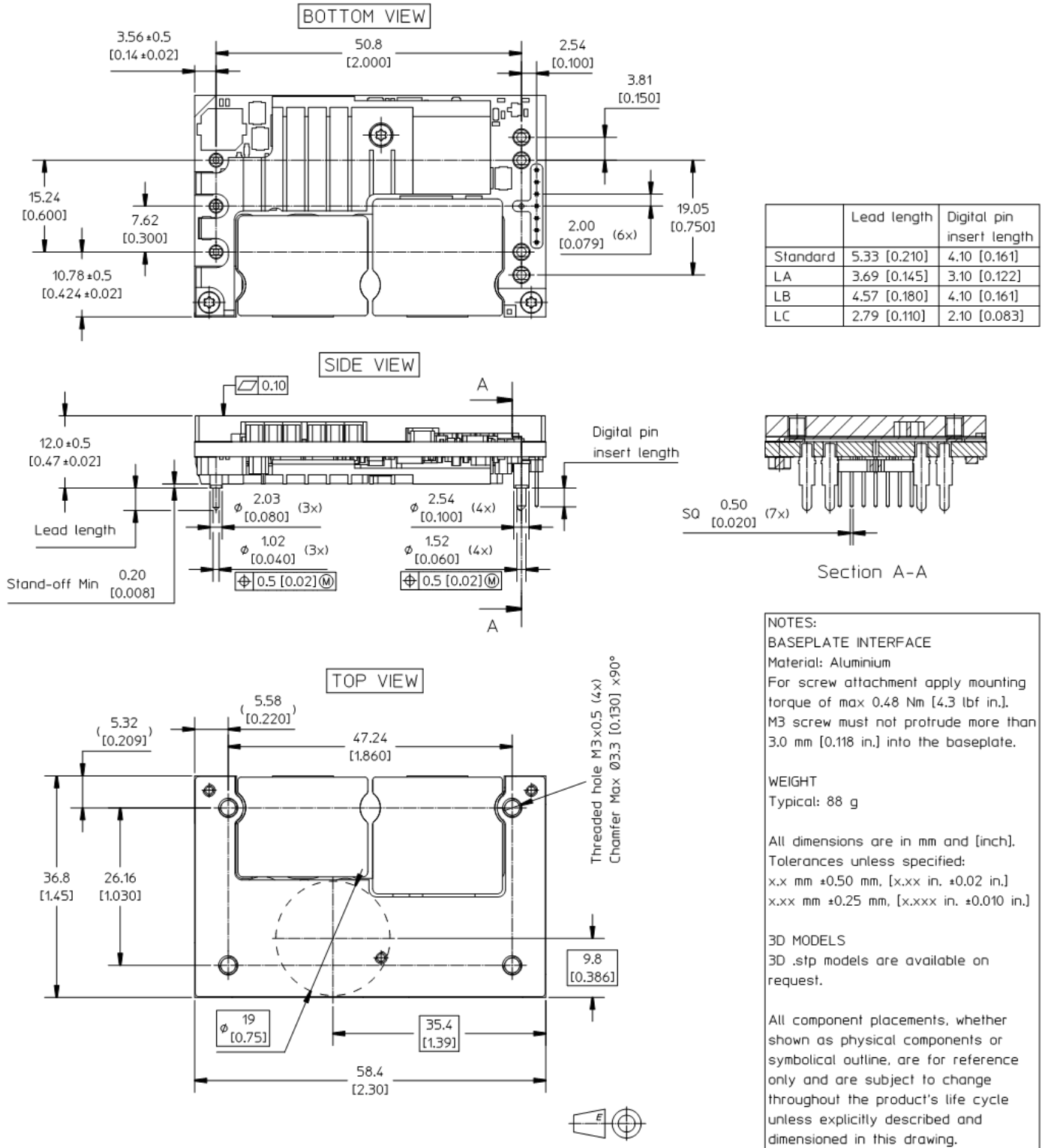

The mechanical information is based on a module which is hole mounted and has a baseplate.

Footprint and pin positions

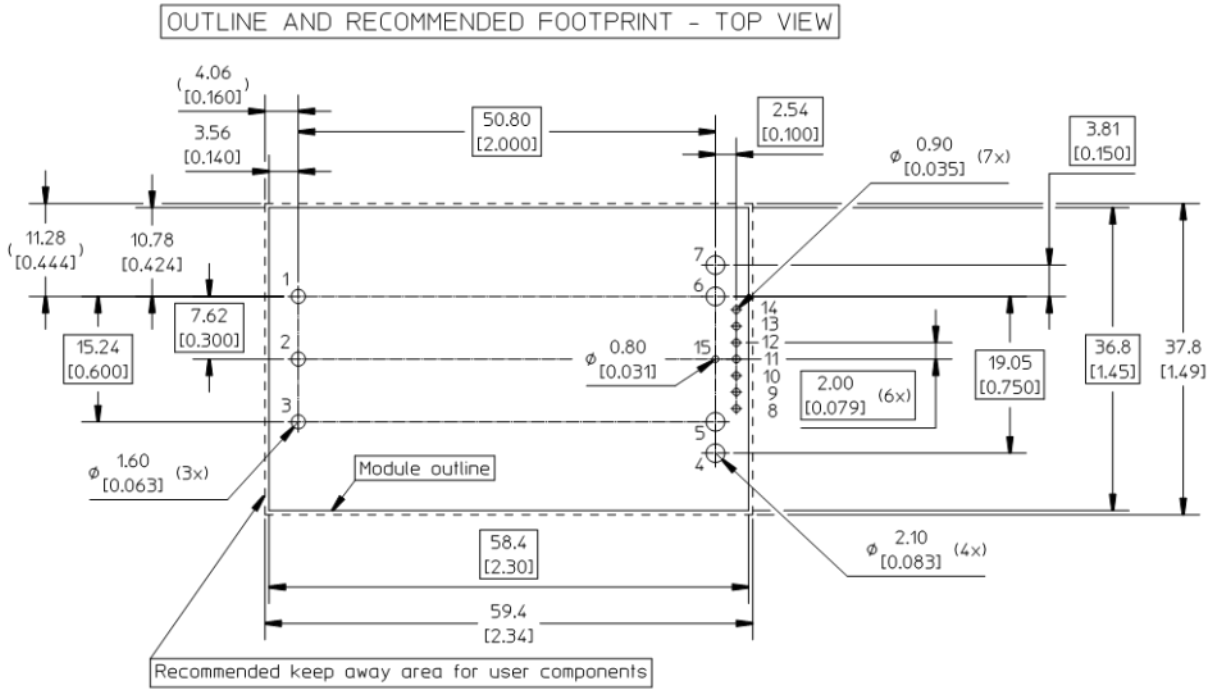

CONNECTIONS - BOTTOM VIEW

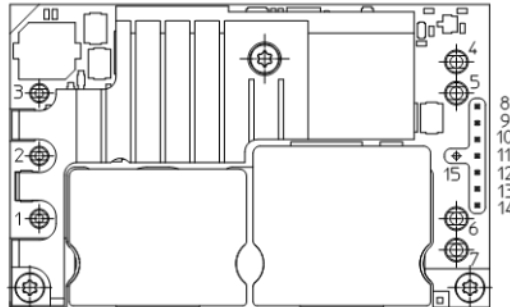

PIN SPECIFICATIONS:

Pin 1-3, 4-7 Material: Copper alloy
Plating: Min Au 0.1 µm over Ni 1-3 µm

Pin 8-14 Material: Brass
Plating: Min Au 0.1 µm over Ni 1-3 µm

Pin 15 Not mounted (Option)

Pin	Designation	Function 7 pin
1	+In	Positive Input
2	RC	Remote Control
3	-In	Negative Input
4	-Out	Negative Output
5	-Out	Negative Output
6	+Out	Positive Output
7	+Out	Positive Output

Pin	Designation	Function 7 pin
8	PG	Power Good
9	SENSE-	Remote Sense-
10	SDA	PMBus Data
11	SALERT	PMBus alert signal
12	SCL	PMBus Clock
13	SA1	PMBus Address 1
14	SENSE+	Remote Sense+

Part 4: Thermal considerations

Thermal considerations

The products are designed to operate in different thermal environments and sufficient cooling must be provided to ensure reliable operation.

General

For products mounted on a PWB without a heatsink attached, cooling is achieved mainly by conduction, from the pins to the host board, and convection, which is dependent on the airflow across the product. Increased airflow enhances the cooling of the product. The wind speed and temperature are measured in a point upstream the device. The *output current derating graphs* found later in this section for each model provide the available output current vs. ambient air temperature and air velocity at $V_{in} = 51\text{ V}$.

For products using any form of heatsink structure a top spacing board and side airflow guides are used to ensure airflow hitting the module and not diverted away.

Distance between the tested device and the top space board and the side airflow guides are $6.35\text{ mm} \pm 1\text{ mm}$.

The product is tested on a $185 \times 185\text{ mm}$, $105\text{ }\mu\text{m}$ (3 oz), 6-layer test board mounted vertically in a wind tunnel.

For products with baseplate used in a sealed box/cold wall application, cooling is achieved mainly by conduction through the cold wall. The product is tested in a sealed box test set up with ambient temperatures 85°C . See [Design Note 028](#) for further details.

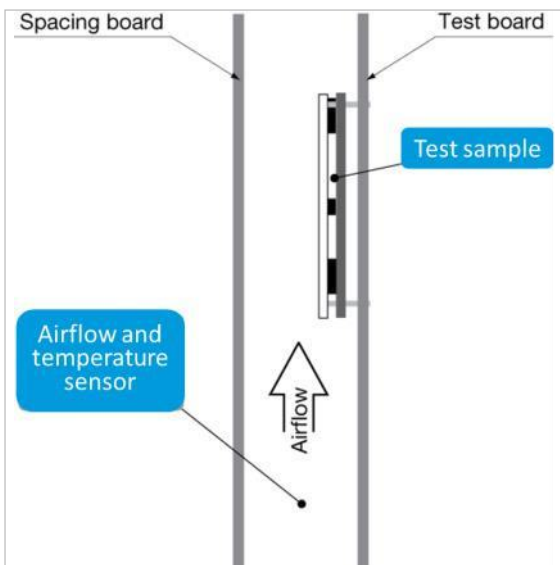

Picture: general test set-up

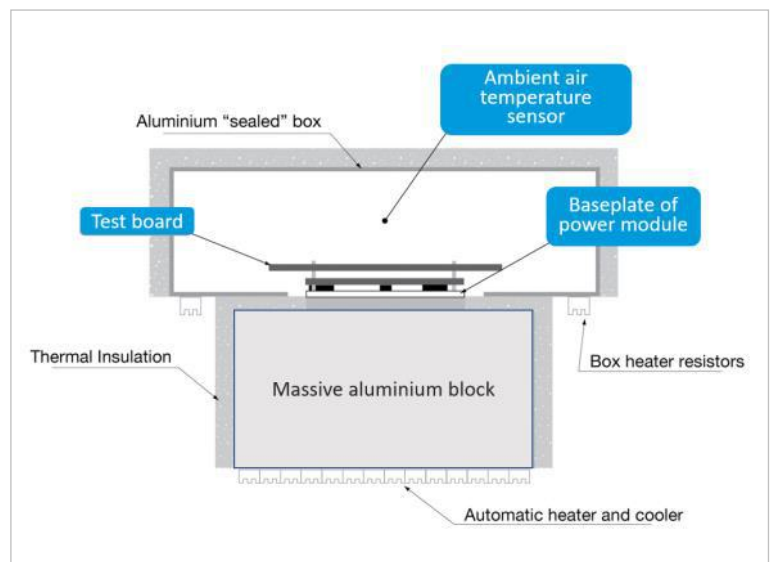

Picture: cold wall test set-up

Part 4: Thermal considerations

Definition of product operating temperature

Proper thermal conditions can be verified by measuring the temperature at position P1 as shown below. The temperature at this position (T_{P1}) should not exceed the maximum temperatures in the table below. The number of measurement points may vary with different thermal design and topology. Temperatures above maximum T_{P1} , measured at the reference point P1 are not allowed and may cause permanent damage.

Position	Description	Max. Temp.
P1	PWB reference point	$T_{P1} = 125\text{ °C}$

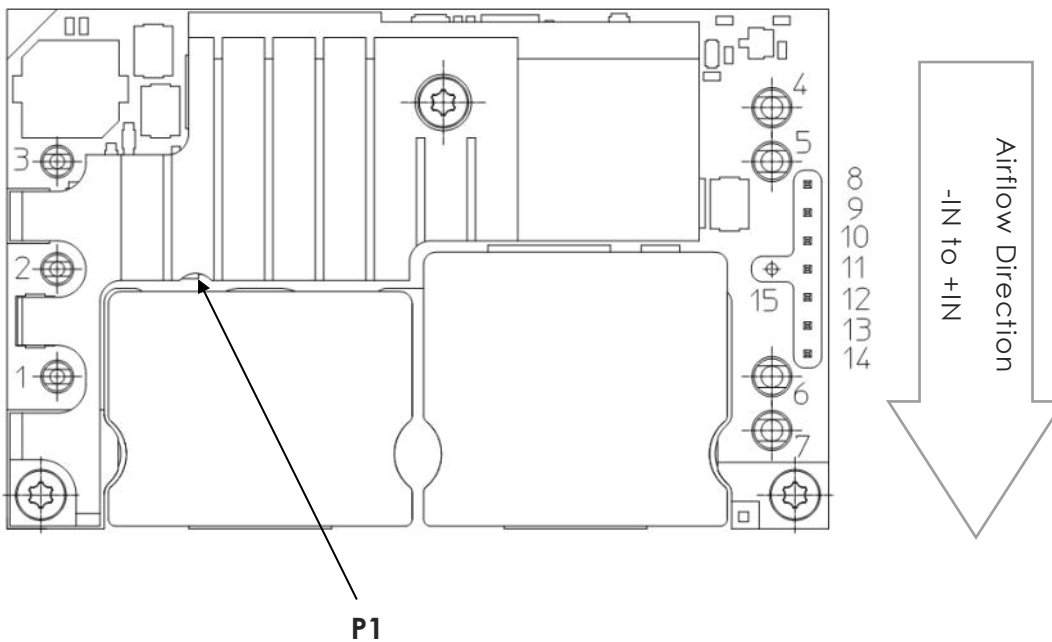
Bottom view

Thermal graphs

Output power derating - 1.0 inch heatsink

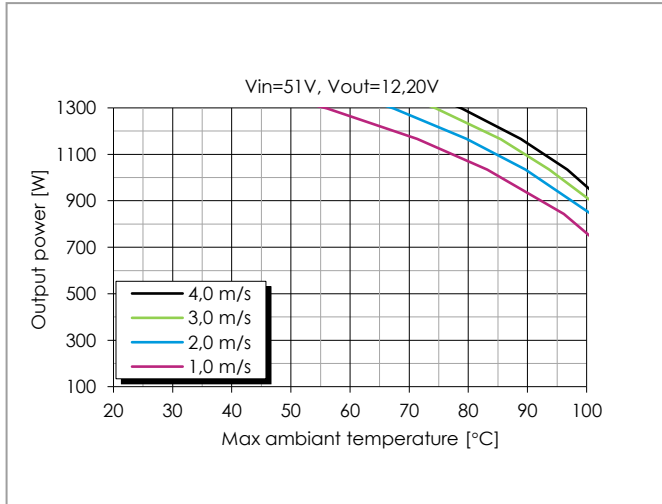

Available output power vs. ambient air temperature and airflow. Above Pout_TDP, 1300W only for a limited time. Airflow Direction -IN to +IN.

Output power derating - 0.5 inch heatsink

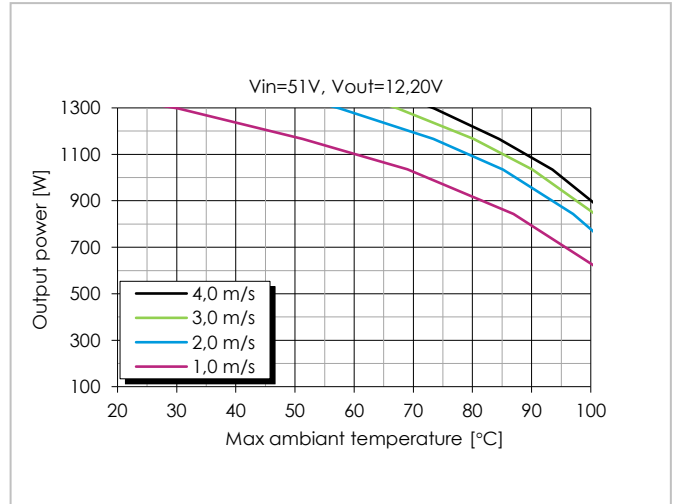

Available output power vs. ambient air temperature and airflow. Above Pout_TDP, 1300W only for a limited time. Airflow Direction -IN to +IN.

Maximum Output Power

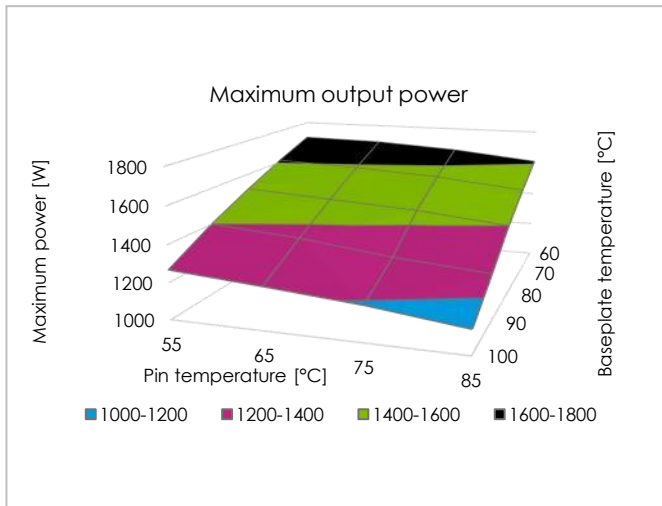

Maximum allowed thermal power (restriction by POMAX might occur). Above Pout_TDP, 1300W only for a limited time.

Maximum Allowed Power Loss

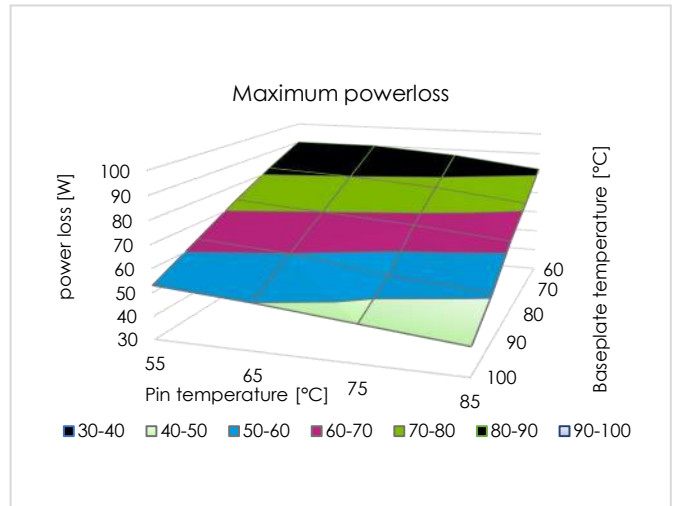

Available output power vs. pin and baseplate temperature See Thermal Consideration section. Above Pout_TDP, 1300W only for a limited time.

For more information, please refer to our [thermal models](#) on the website.

Part 5: Packaging

Packaging information

H option: Select for PIP reflow solder and pick & place - dry packed

Material	Antistatic Polyphenylene Ester (PPE)
Surface resistance	$\geq 1 \times 10^4$ to $< 1 \times 10^{11}$ ohms
Bakability	Tray can be baked at max. 125 °C for 24 h.
Tray thickness	25.0 mm 0.984 [inch]
Tray capacity	14 converters/tray
Box capacity	42 products (3 full trays/box)
Tray weight	156g empty tray, 1385g full tray - open deck baseplate.

JEDEC standard tray.
All dimensions in mm

Tolerances: X.x ± 0.26 [0.01], X.xx ± 0.13 [0.005]

Note: Pick up positions refer to center of pocket.

See [mechanical drawing](#) for exact location on product.

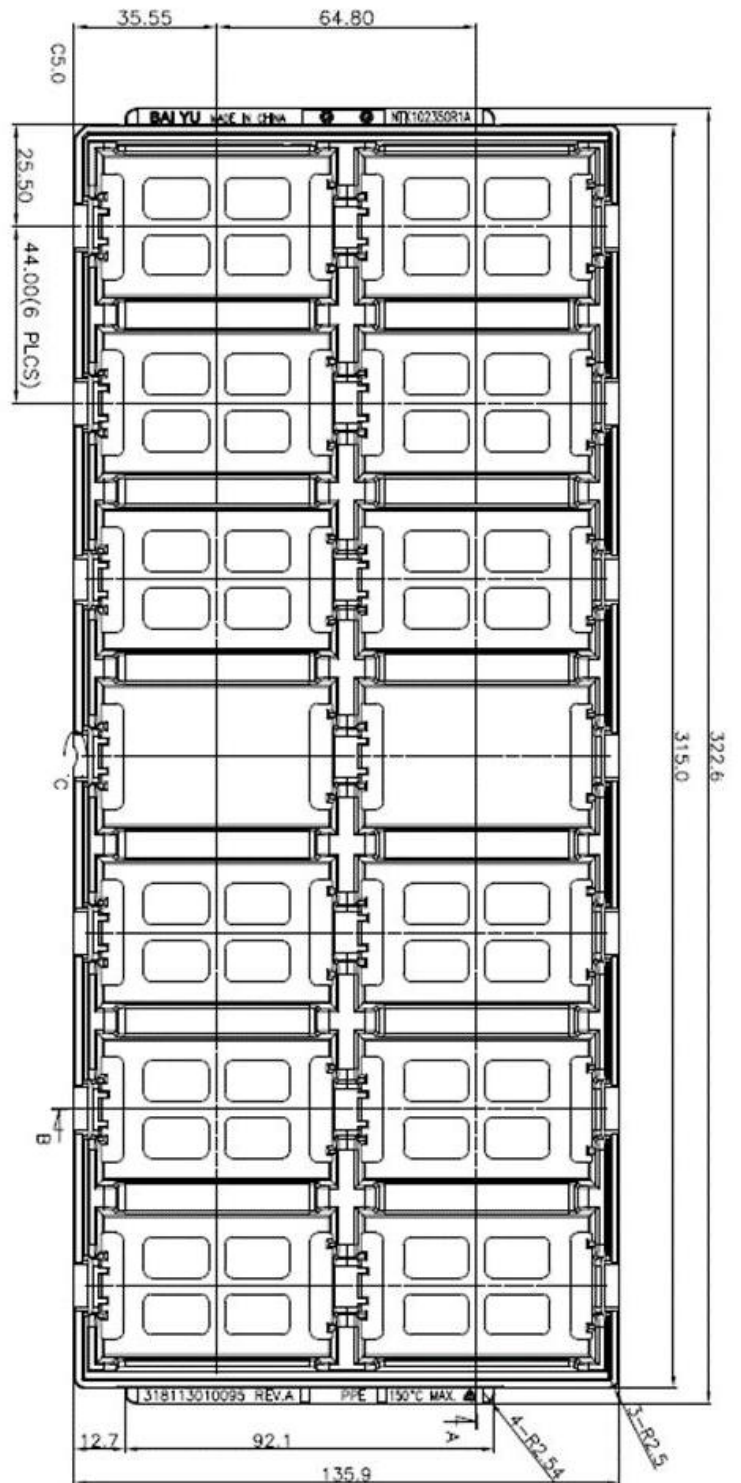

Example hard tray (14 pcs)

Packaging information

Blank option: Select for wave or hand soldering, NOT dry packed

Material	Antistatic Polyethylene (PE) foam
Surface resistance	$\geq 1 \times 10^4$ to $< 1 \times 10^{11}$ ohms
Bakability	Tray cannot be baked
Tray capacity	20 converters / tray
Box capacity	60 products (3 full trays/box)
Weight	48 g empty tray, 1800g full tray.

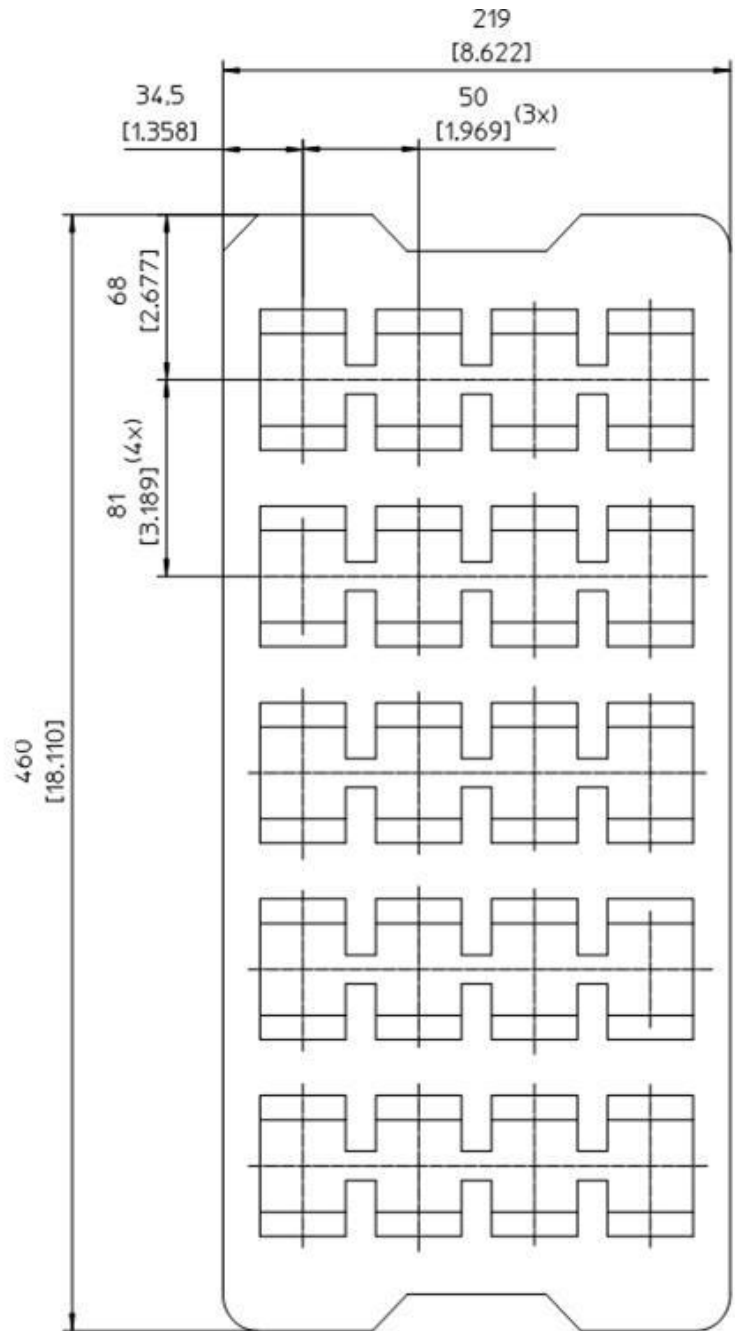

Example PE foam tray

Part 6: Revision history

Revision table

Revision number	revision change	date	revisor
A	New	2023/2/10	jidmawan
B	Update hardtray and packing weight & modified value of slow ocp	2023/3/9	jjdjliaa

© Flex Power Modules 2023

The information and specifications in this technical specification is believed to be correct at the time of publication. However, no liability is accepted for inaccuracies, printing errors or for any consequences thereof. Flex reserves the right to change the contents of this technical specification at any time without prior notice.

flex[®]

Flex Power Modules, a business line of Flex, is a leading manufacturer and solution provider of scalable DC/DC converter primarily serving the data processing, communications, industrial and transportation markets. Offering a wide range of both isolated and non-isolated solutions, its digitally-enabled DC/DC converters include PMBus compatibility supported by the powerful [Flex Power Designer](#).



TECHNICAL REFERENCE DOCUMENT: GENERAL INFORMATION

Compatibility with RoHS requirements

The products are compatible with the relevant clauses and requirements of the *RoHS directive 2011/65/EU* and *2015/863* have a maximum concentration value of 0.1% by weight in homogeneous materials for lead, mercury, hexavalent chromium, PBB, PBDE, DEHP, BBP, DBP, DIBP and of 0.01% by weight in homogeneous materials for cadmium.

Exemptions in the RoHS directive utilized in Flex Power Modules products are found in the Statement of Compliance document.

Flex Power Modules fulfills and will continuously fulfill all its obligations under regulation (EC) No 1907/2006 concerning the registration, evaluation, authorization and restriction of chemicals (REACH) as they enter into force and is through product materials declarations preparing for the obligations to communicate information on substances in the products.

Quality statement

The products are designed and manufactured in an industrial environment where quality systems and methods like *ISO 9000*, *Six Sigma*, and *SPC* are intensively in use to boost the continuous improvements strategy. Infant mortality or early failures in the products are screened out and they are subjected to an ATE-based final test. Conservative design rules, design reviews and product qualifications, plus the high competence of an engaged workforce, contribute to the high quality of the products.

Warranty

Warranty period and conditions are defined in *Flex Power Modules' General Terms and Conditions of Sales*.

Limitation of Liability

Flex Power Modules does not make any other warranties, expressed or implied including any warranty of merchantability or fitness for a particular purpose (including, but not limited to, use in life support applications, where malfunctions of product can cause injury to a person's health or life).

Product qualification specifications

Characteristics			
External visual inspection	IPC-A-610		
Temperature shock test (Temperature cycling)	IEC 60068-2-14 Na	Temperature range Number of cycles Dwell/transfer time	-40 to 125°C 700 15 min/0-1 min
Cold (in operation)	IEC 60068-2-1 Ad	Temperature T _A Duration	-45°C 72 h
Damp heat	IEC 60068-2-67 Cy	Temperature Humidity Duration	85°C 85% RH 1000 hours
Dry heat	IEC 60068-2-2 Bd	Temperature Duration	125°C 1000 h
Electrostatic discharge susceptibility	IEC 61340-3-1, JESD 22-A114 IEC 61340-3-2, JESD 22-A115	Human body model (HBM) Machine Model (MM)	Class 2, 2000 V Class 3, 200 V
Immersion in cleaning solvents	IEC 60068-2-45 XA, method 2	Water	55°C
Mechanical shock	IEC 60068-2-27 Ea	Peak acceleration Duration	100 g 6 ms
Moisture reflow sensitivity ¹	J-STD-020E	Level 1 (SnPb-eutectic) Level 3 (Pb Free)	225°C 245°C
Operational Life test Rapid Temp.	MIL-STD-202G, method 108A	Duration	1000 h
Resistance to soldering heat ²	IEC 60068-2-20 Tb, method 1A	Solder temperature Duration	270°C 10-13 s
Robustness of terminations	IEC 60068-2-21 Test Ua1 IEC 60068-2-21 Test Ue1	Through hole mount products Surface mount products	All leads All leads
Solderability	IEC 60068-2-20 test Ta	Preconditioning Temperature, Pb-free	Steam ageing 245°C
Vibration, broad band random	IEC 60068-2-64 Fh, method 1	Frequency Spectral density Duration	10 to 500 Hz 0.07 g ² /Hz 10 min in each direction

Note 1: only for products intended for reflow soldering (surface mount products & pin-in paste products)

Note 2: only for products intended for wave soldering (plated through hole products)

TECHNICAL REFERENCE DOCUMENT: DESIGN & APPLICATION GUIDELINES

OPERATING INFORMATION: COMMON FEATURES

The features listed in the following pages are common to DC/DC converters.

Turn on and off input voltage

The product monitors the input voltage and will turn on and turn off at configured thresholds (see *Technical Specification: part 1 - Electrical Specification*). The turn-on input voltage threshold is set higher than the corresponding turn-off threshold. Hence, there is a hysteresis between turn-on and turn-off input voltage levels.

Input voltage transient

The end-user must secure that the transient voltage will not exceed the value stated in the Technical Specification under Absolute maximum ratings of each product. ETSI TR 100 283 examines the parameters of DC distribution networks and provides guidelines for controlling the transient and reduce its harmful effect.

Remote control (RC)

The products are fitted with a remote control function referenced to the primary negative input connection (-In), with negative logic options available. The RC function allows the product to be turned on/off by an external device like a semiconductor or mechanical switch. The RC pin has an internal pull up resistor.

The external device must provide a minimum required sink current >0.5 mA to guarantee a voltage not higher than maximum voltage on the RC pin (see Electrical characteristics table). To turn off the product the RC pin should be left open for a minimum time of 150 μ s, the same time requirement applies when the product shall turn on. When the RC pin is left open, the voltage generated on the RC pin is max 5 V. The standard product is provided with "negative logic" RC and will be off until the RC pin is connected to the -In. To turn off the product the RC pin should be left open. In situations where it is desired to have the product to power up automatically without the need for control signals or a switch, the RC pin shall be wired directly to -In.

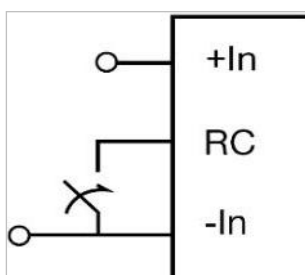

Remote control

Input and output impedance

The impedance of both the input source and the load will interact with the impedance of the product. It is important that the input source has low characteristic impedance. Minimum recommended external input capacitance is given in the *Technical Specification*. Electrolytic capacitors will be degraded in low temperature. The needed input capacitance in low temperature should be equivalent to the value stated in the *Technical Specification* at 25°C. The performance in some applications can be enhanced by addition of external capacitance as described under External decoupling capacitors (next paragraph). If the input voltage source contains significant inductance, the addition of a low ESR ceramic capacitor of 22 – 100 µF capacitor across the input of the product will ensure stable operation. The minimum required capacitance value depends on the output power and the input voltage. The higher output power the higher input capacitance is needed.

External decoupling capacitors

When powering loads with significant dynamic current requirements, the voltage regulation at the point of load can be improved by addition of decoupling capacitors at the load.

The most effective technique is to locate low ESR ceramic and electrolytic capacitors as close to the load as possible, using several parallel capacitors to lower the effective ESR. The ceramic capacitors will handle high-frequency dynamic load changes while the electrolytic capacitors are used to handle low frequency dynamic load changes. It is equally important to use low resistance and low inductance PWB layouts and cabling.

External decoupling capacitors will become part of the product's control loop. The control loop is optimized for a wide range of external capacitance and the maximum recommended value that could be used without any additional analysis is found in the *Technical Specification* under Electrical specifications. Output filter can be configured and simulated based on the needed control loop and transient response.

For further information please contact your local Flex Power Modules' representative or email us at pm.info@flex.com.

Output voltage adjust using PMBus

The output voltage of the product can be reconfigured via PMBus command VOUT_COMMAND (0x21) or VOUT_TRIM (0x22). This can be used when adjusting the output voltage above or below output voltage initial setting up to a certain level, see Electrical specification for adjustment range.

When changing the output voltage, the voltage at the output pins must be kept within Vtrim max and Vtrim min. Output voltage setting must be kept below the threshold of the over voltage protection (OVP) to prevent the product from shutting down. At increased output voltages the maximum power rating of the product remains the same, and the max output current must be decreased correspondingly.

Margin up and down control

These controls allow the output voltage to be momentarily adjusted, either up or down, by a nominal 10%. The margin high and margin low shall be limited to max and min output voltage, if the nominal output voltage is changed. This provides a convenient method for dynamically testing the operation of the load circuit over its supply margin or range. It can also be used to verify the function of supply voltage supervisors.

The margin up and down levels of the product can easily be re-configured using [Flex Power Designer software](#).

Soft start power up and soft stop

The default rise time for a single product is 10 ms. The soft-start and soft-stop control functionality allows the output voltage to ramp-up and ramp-down with defined timing with respect to the control of the output. This can be used to control inrush current and manage supply sequencing of multiple controllers.

The rise time is the time taken for the output to ramp to its target voltage, while the fall time is the time taken for the output to ramp down from its regulation voltage to 0 V. The TON_DELAY (0x60) sets a delay from when the output is enabled until the output voltage starts to ramp up. When starting by applying input voltage the control circuit boot-up time adds approximately an additional 15 ms delay. The TOFF_DELAY (0x64) sets a delay from when the output is disabled until the output voltage starts to ramp down.

By default, soft-stop is disabled, and the regulation of output voltage stops immediately when the output is disabled. Soft-stop can be enabled through the PMBus command ON_OFF_CONFIG (0x02). The delay and ramp times can be reconfigured using the PMBus commands TON_DELAY (0x60), TON_RISE (0x61), TOFF_DELAY (0x64) and TOFF_FALL (0x65).

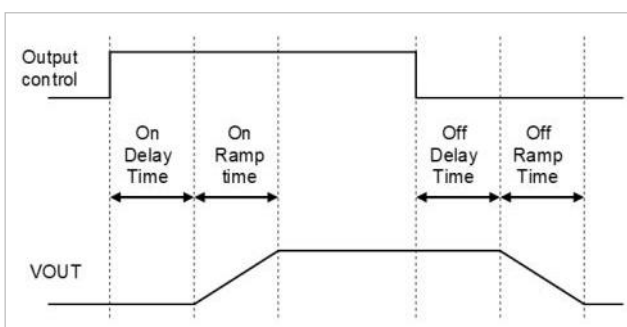

Soft start power up

Pre-bias start-up

The product has a pre-bias start up functionality and will not sink current during start up if a pre-bias source is present at the output terminals. If the pre-bias voltage is lower than the target value set in VOUT_COMMAND (0x21), the product will ramp up to the target value. If the pre-bias voltage is higher than the target value set in VOUT_COMMAND (0x21), the product will ramp down to the target value and in this case sink current for a time interval set by the command TOFF_MAX_WARN_LIMIT (0x66).

Over/under temperature protection (OTP/UTP)

The products are protected from thermal overload by an internal over temperature sensor. The product will make continuous attempts to start up (non-latching mode) and resume normal operation automatically when the temperature has dropped below the temperature threshold set in command OT_WARN_LIMIT (0x51). The OTP and hysteresis of the product can be re-configured using the PMBus interface. The product also has an under-temperature protection. The OTP and UTP fault limit and fault response can be configured via the PMBus.

Note: using the fault response "continue without interruption" may cause permanent damage to the product.

Input over/under voltage protection

The product can be protected from high input voltage and low input voltage by a pre-configured value with a response time of 70µs. The over/under-voltage fault level and fault response is easily configured using Flex Power Designer software.

For more information, see *Technical Reference Document: PMBus*.

Output Over Voltage Protection (OVP)

The product includes over voltage limiting circuitry for protection of the load. The default OVP limit is 30% above the nominal output voltage. If the output voltage exceeds the OVP limit, the product can respond in different ways.

The default response from an over voltage fault is to immediately shut down, with a response time of ~70µs. The device will continuously check for the presence of the fault condition, and when the fault condition no longer exists the device will be re-enabled.

The OVP fault level and fault response can be configured via the PMBus interface

For more information, see *Technical Reference Document: PMBus*.

Over current protection (OCP)

The products include current limiting circuitry for protection at continuous overload. For standard configuration the output voltage will shutdown and automatic restart (hiccup mode) for output currents in excess of max output current (max I_o). The product will retry 3 times with 1s delay time between each retry attempt. The load distribution should be designed for the maximum output short circuit current specified.

The over current protection of the product can be configured via the PMBus interface

For more information, see *Technical Reference Document: PMBus*.

Switching frequency

The product is optimized at the frequency given in the Technical Specification under part 1- Electrical Specification, but can run at lower and higher frequencies through PMBus configuration. The electrical performance can be affected at different frequencies. Please contact your local Flex Power Modules FAE for more details.

Multi pin configurations

The MFR_MULTI_PIN_CONFIG (0xF9) command can be re-configured using the PMBus interface to enable or disable different functions and set the pin configuration of the digital header.

The MULTI_PIN_CONFIG is easily configured using [Flex Power Designer](#).

For more information, see *Technical Reference Document: PMBus*.

Address offset

The command FW_CONFIG_PMBUS (0xC9) can be configured to utilize different address offset option. There are 3 different address setting option.

1. The bit 16 in command 0xC9 must be set to 1 to enable PMBus address offset via resistors.
2. The resistor address offset in combination with a value set by PMBus base address offset, [31:24] in command FW_CONFIG_PMBUS (0xC9). This can be chosen when 1 address resistor is used.
3. A pre-configured PMBus address, [23:17] in FW_CONFIG_PMBUS (0xC9). The bit 16 in command 0xC9 must be set to 0 to enable digital PMBus address offset. The digital PMBus address offset in combination with a digital PMBus base address offset, [31:24] in command FW_CONFIG_PMBUS (0xC9) adds a larger range of address possibilities. This combination can be chosen if no address resistors are used.

The PMBus-address offset's with resistor value increments the address value following the formula in the PMBus Addressing section of documentation. This increases flexibility when the part is used in single-pin and no-pin addressing scenarios.

Feed Forward Capability

The BMR350 products have a Feed Forward function implemented that can handle sudden input voltage changes. The output voltage will be regulated during an input transient and will typically stay within 10% when an input transient is applied. The Feed Forward acts on both positive and negative input voltage transients.

Output ripple and noise

Output ripple and noise measured according to figure below.
See [Design Note 022](#) for detailed information

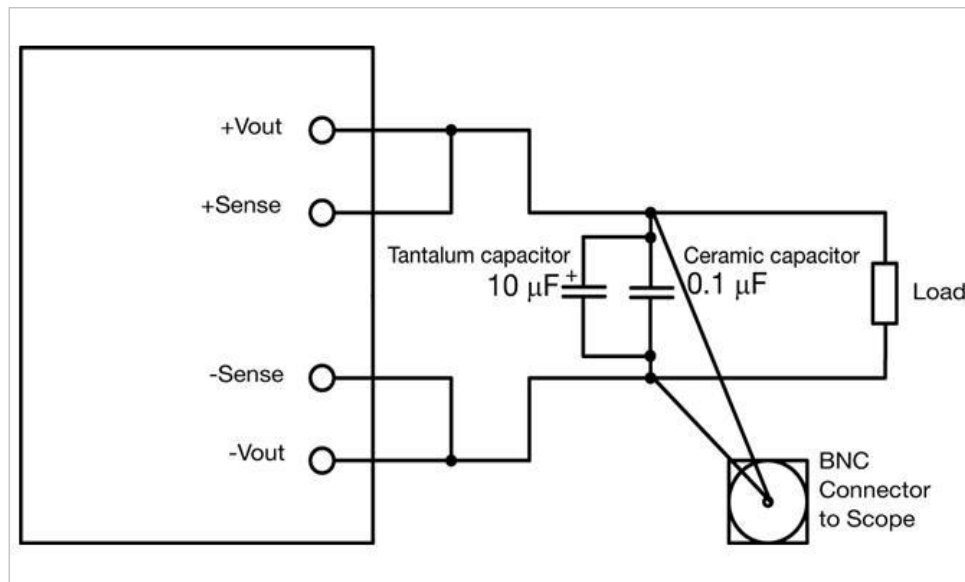

Output ripple and noise test set-up

Non-Volatile Memory (NVM)

The product incorporates two Non-Volatile Memory areas for storage of the PMBus command values; the Default NVM and the User NVM. The Default NVM is pre-loaded with Flex factory default values. The Default NVM is write-protected and can be used to restore the Flex factory default values through the command RESTORE_DEFAULT_ALL (0x12).

The User NVM is pre-loaded with Flex factory default values. The User NVM is writable and open for customization. The values in NVM are loaded during initialization according to section Initialization Procedure, where after commands can be changed through the PMBus Interface.

The module contains a one-time programmable memory (OTP) used to store configuration settings, which will not be programmed into the device OTP automatically. The STORE_USER_ALL(0x15) commands must be used to commit the current settings are transferred from RAM to OTP as device defaults.

Note: The one-time programmable memory (OTP) has limited storing times, frequent use of STORE_USER_ALL command can lead to memory space exhaustion. Remaining available memory is displayed in Flex Power Designer. To retrieve OTP memory MFR_FLEX_FIRMWARE_CMD (0xE0) can be used, see section OTP Memory Check.

OPERATING INFORMATION: PRODUCT SPECIFIC FEATURES

OTP Memory Check

This command, MFR_FLEX_FIRMWARE_CMD (0xE0), can be used to retrieve information about OTP memory. The command works by first writing an 8 byte large block containing instructions for what information to retrieve and then that information is accessed by performing a block read operation. The first 8 bits in the request block contains a sub-command code. The usable codes are described in the following examples:

Read OTP partition size (cmd=0). Retrieves the memory size of a specific partition. This is the size that was set during the OTP partition trim process.

Request:

0	1	2	3	4	5	6	7	8	15	16	31
0	0	0	0	0	0	0	0	0	OTP partition		Unused
Unused											

Response:

0	31
Partition size in bytes	
Unused	

Read remaining memory size of OTP partition (cmd=1). Retrieves the remaining memory size of a specific partition. This is the size that is still available for writing patches, which depending on the partition can be firmware patches, PMBus configuration patches or snapshot events.

Request:

0	1	2	3	4	5	6	7	8	15	16	31
1	0	0	0	0	0	0	0	0	OTP partition		Unused
Unused											

Response:

0	31
Remaining size in bytes	
Unused	

Read size of STORE_X_ALL memory usage (cmd=2). Retrieves the memory used when storing a full PMBus configuration through STORE_DEFAULT_ALL or STORE_USER_ALL. This includes padding bytes for alignment, the OTP frame size and checksum.

Request:

0	1	2	3	4	5	6	7	8	15	16	31
0	1	0	0	0	0	0	0	0	OTP partition		Unused
Unused											

Response:

0	31
Block size in bytes	
Unused	

Power good

The power good pin (PG) indicates when the product is ready to provide regulated output voltage to the load. During ramp-up and during a fault condition, PG is held **low**. By default, PG is asserted **high** after the output has ramped to setting according to POWER_GOOD_ON (0x5E), and de-asserted if the output voltage falls below the setting according to POWER_GOOD_OFF (0x5F). These thresholds may be changed using the PMBus commands POWER_GOOD_ON (0x5E) and POWER_GOOD_OFF (0x5F).

By default, the PG pin is configured as open drain output, but it is also possible to set the output in push/pull mode by the command MFR_MULTI_PIN_CONFIG (0xF9).

The polarity is by default configured to active high, the polarity of PG can be set to active **high** using bit [39] in the command FW_CONFIG_PMBUS (0xC9) :

bit[39] = 0 (active low)

bit[39] = 1 (active high)

The product provides a Power Good flag in the Status Word register that indicates the output voltage is within a specified tolerance of its target level and no-fault condition exists. It is not recommended to use push-pull when paralleling PG- pins.

For more information, see *Technical Reference Document: PMBus*.

Remote Control (secondary side)

The CTRL pin (Pin 7) can be configured as remote control in combination with hardware and PMBus configuration. With hardware option, Pin 7 used for secondary remote control, Power Good is disabled. The secondary remote control uses an internal pull-up resistor. The logic options for the secondary remote control can be positive or negative logic. The logic option for the secondary remote control is easily configured via ON_OFF_CONFIG (0x02) using Flex Power Designer software command.

Parallel operation Droop Load Sharing (DLS)

Two or more products may be paralleled for redundancy if the total power is equal or less than $P_{O\max}$. The products provide output voltage droop corresponding to pre-configured artificial resistance in the output circuit to enable direct paralleling. The stated output voltage set point is at no load. The output voltage will decrease when the load current is increased. This feature allows the products to be connected in parallel and share the current. This feature allows the products to be connected in parallel and share the current with 10% accuracy at max output power. This means that up to 90% of max rated current from each module can be utilized. The product measures reversed current, and will compensate the output voltage in these situations. At reversed current $> 35A$ the product will shut down immediately. Note that continuous restarts after a fault ("hiccup mode") are not recommended for parallel operation. Droop Load Share variants (DLS) will have a default response from an OCP fault consisting of a response delay of 2ms then immediately shut down. To prevent unnecessary current stress, changes of the output voltage must be done with the output disabled. This must be considered for all commands that affect the output voltage.

Peak power / Slow OCP

In order to handle higher power than the thermal design power (TDP), the DC/DC converter has a peak power level with a time factor limitation configured by Slow OCP function. Thus, a higher power than TDP can be achieved but for a shorter period of time.

Between TDP current and OCP limit, a slow OCP protection is enabled based on averaging power over time. The function is configured to allow a load step from TDP to Peak Power level for 200ms. Even higher power can be achieved but for a decreased time period. See technical specification for Slow OCP configuration limits.

High di/dt on load step up to peak power, might cause current overshoot resulting in OCP fault. Maximum load step slew rate is application dependent and can vary between systems. Application test is required to find maximum load step slew rate.

For further assistance, contact your local Flex Power Modules' representative or email us to pm.info@flex.com

POWER MANAGEMENT

PMBUS overview

This product is equipped with a PMBus interface. The product incorporates a wide range of readable and configurable power management features that are simple to implement with a minimum of external components. Additionally, the product includes protection features that continuously safeguard the load from damage due to unexpected system faults. A fault is also shown as an alert on the SALERT pin. The following product parameters can continuously be monitored by a host: Input voltage, output voltage/current, duty cycle and internal temperature.

The product is delivered with a default configuration suitable for a wide range operation in terms of input voltage, output voltage, and load. The configuration is stored in an internal Non-Volatile Memory (NVM). All power management functions can be reconfigured using the PMBus interface.

Throughout this document, different PMBus commands are referenced. The Flex Power Designer software suite can be used to configure and monitor this product via the PMBus interface. More information is found on [our website](#).

SMBus interface

This product provides a PMBus digital interface that enables the user to configure many aspects of the device operation as well as to monitor the input and output voltages, output current and device temperature. The product can be used with any standard two-wire I²C (master must allow for clock stretching) or SMBus host device. In addition, the product is compatible with PMBus version 1.3 and includes an SALERT line to help mitigate bandwidth limitations related to continuous fault monitoring. The product supports 100 kHz and 400 kHz bus clock frequency only. The PMBus signals, SCL, SDA and SALERT require passive pull-up resistors as stated in the SMBus Specification. Pull-up resistors are required to guarantee the rise time as follows:

$$\tau = R_p C_p \leq 1\mu s \quad \text{Eq. 7}$$

where R_p is the pull-up resistor value and C_p is the bus load. The maximum allowed bus load is 400 pF. The pull-up resistor should be tied to an external supply between 2.7 to 3.8 V, which should be present prior to or during power-up. If the proper power supply is not available, voltage dividers may be applied. Note that in this case, the resistance in the equation above corresponds to parallel connection of the resistors forming the voltage divider.

It is recommended to always use PEC (Packet Error Check) when communicating via PMBus.

PMBus addressing

The following figure and table show recommended resistor values with min and max voltage range for hard-wiring PMBus addresses (series E96, 1% tolerance resistors suggested):

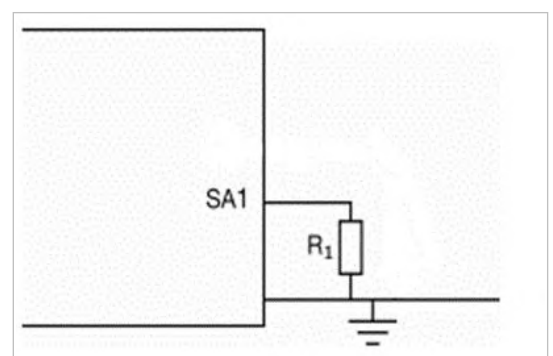

Schematic of connection address resistors

SA1 index	R _{SA1} [kΩ]	Resulting address with MFR_OFFSET_ADDRESS = 0x60
0	10	96d (0x60)
1	15	97d (0x61)
2	21	98d (0x62)
3	28	99d (0x63)
4	35.7	100d (0x64)
5	45.3	101d (0x65)
6	56.2	102d (0x66)

SA1 index	R _{SA1} [kΩ]	Resulting address with MFR_OFFSET_ADDRESS = 0x60
7	69.8	103d (0x67)
8	88.7	104d (0x68)
9	107	105d (0x69)

PMBus base address offset value is configured via PMBus command 0xC9. Specific variants may already have a default non-zero value set for PMBus base address offset.

Configuring the address setup by command FW_CONFIG_PMBUS (0xC9), see section Offset Address.

The allowed range of the PMBus address is: 1-126 excluding 12 and 16. When the calculated PMBus address falls outside the allowed range address 126 is assigned instead. It is not recommended to keep the SA1 pins left open.

I2C/SMBus timing

The setup time, t_{set} , is the time data, SDA, must be stable before the rising edge of the clock signal, SCL. The hold time t_{hold} , is the time data, SDA, must be stable after the rising edge of the clock signal, SCL. If these times are violated incorrect data may be captured or meta-stability may occur and the bus communication may fail. All standard SMBus protocols must be followed, including clock stretching. This product supports the BUSY flag in the status commands to indicate product being too busy for SMBus response. A bus-free time delay between every SMBus transmission (between every stop & start condition) must occur. Refer to the SMBus specification, for SMBus electrical and timing requirements.

Note that an additional delay of 5 ms has to be inserted in case of storing the RAM content into the internal non-volatile memory.

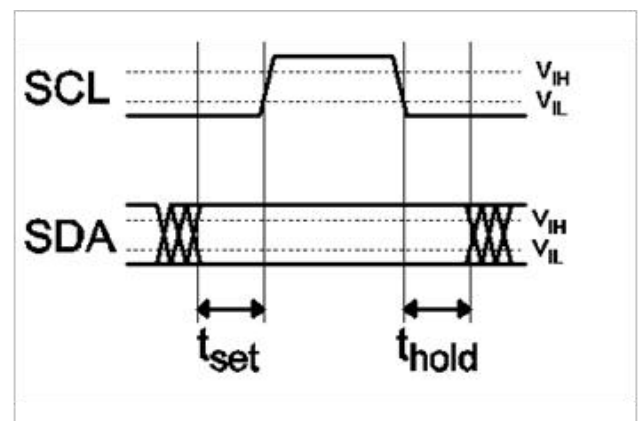

Set-up and hold timing diagramm

Monitoring via PMBus

It is possible to continuously monitor a wide variety of parameters through the PMBus interface. These include, but are not limited to, the parameters listed in the table below.

Parameter	PMBus command
Input voltage	READ_VIN
Output voltage	READ_VOUT
Output current	READ_IOUT
Temperature*	READ_TEMPERATURE_1
Switching frequency	READ_FREQUENCY
Duty cycle	READ_DUTY_CYCLE

* reports the temperature from temperature sensor set in command 0xDC, internal (controller IC)/external (temp. sensor)

Monitoring faults

Fault conditions can be detected using the SALERT pin, which will be asserted low when any number of pre-configured fault or warning conditions occurs. The SALERT pin will be held low until faults and/or warnings are cleared by the CLEAR_FAULTS command, or until the output voltage has been re-enabled. It is possible to mask which fault conditions should not assert the SALERT pin by the command SMBALERT_MASK. In response to the SALERT signal, the user may read a number of status commands to find out what fault or warning condition occurred, see table below.

Fault and warning status	PMBus command
Overview, Power Good	STATUS_BYTE STATUS_WORD
Output voltage level	STATUS_VOUT
Output current level	STATUS_IOUT
Input voltage level	STATUS_INPUT
Temperature level	STATUS_TEMPERATURE
PMBus communication	STATUS_CML
Miscellaneous	STATUS_MFR_SPECIFIC

General PMBus command summary

PMBus signal interfaces characteristics

Characteristic	conditions	minimum	typical	maximum	unit
PMBus signal interface characteristics					
Input clock frequency drift tolerance	External sync.	-4		4	%
Initialization time	From VI > 27 V to ready to be enabled		15		ms
Output voltage total on delay time	Enable by input voltage		T _{INIT} + T _{ONdel}		
	Enable by RC or CTRL pin		T _{ONdel}		
Logic output low signal level	SCL, DA, SYNC, GCB, SALERT, PG, sink/source current = 4 mA			0.4	V
Logic output high signal level		2.6			V
Logic output low sink current				5	mA
Logic output high source current				5	mA
Logic input low threshold	SCL, SDA, CTRL, SYNC			0.6	V
Logic input high threshold		2.1			V
Logic pin input capacitance	SCL, SDA, CTRL, SYNC		1.5		pF
Supported SMBus operating frequency		100		400	kHz
SMBus bus free time	STOP bit to START bit		1.3		μs
SMBus SDA setup time from SCL			100		μs
SMBus SDA hold time from SCL			0		ns
SMBus START/STOP condition setup/hold time from SCL			600		ns
SCL low period		1.3			μs
SCL high period			0.6	50	μs

BLACK BOX/EVENT READER

Overview

A black box, or history event recorder, is provided to capture brick data at the time of fault occurrence. The intent is to assist in fault diagnosis.

Black box will respond to following faults: OVF, OCF, OTF. For each fault a block of data will be stored into a dedicated black box memory partition. This partition consists of 4KiB non-volatile memory and can store a total of 102 events. When the memory section for event recording is filled up, no more black box data can be stored.

When a fault occurs, the following data will be stored:

- Telemetry for Vin, Vout, Iout, temperature and duty
- All PMBus status registers
- Regulation state of module, current and prior to fault.
- Time stamp

If several subsequent faults of the same type occur only the first fault of same type will be recorded. Though, if fault is cleared e.g. with RC or PMBus a new fault of same type will activate a new recording.

All telemetry values are two's complement numbers:

Telemetry	#bits	LSB
Input voltage	16	125 mV
Output voltage	16	488.28125 μ V
Output current	16	500 mA
Temperature	16	1°C
Duty	16	1%

The PMBus status registers have the same form as their corresponding PMBus registers. See section 17 of PMBus specification part II rev 1.3 for details.

Regulation states upper 4 bits represent state prior to fault. Lower 4 bits represent current state.

No.	State:
0	IDLE
1	TON_DELAY
2	RAMP UP
3	REGULATING
4	TOFF_DELAY
5	RAMP DOWN
6	FAULT

Black box/event reader

Time stamp:

Name	#bits	LSB
ticks_hi	8	~1563.75 h
ticks	32	1310.72 μ s

Max: ~45years. Note, due to Non-Volatile memory, ticks counter will restart at 0 each time power is cycled.

Method of retrieving event data

1. Read the number of total events by performing a **Read Word** on 0xDB (MFR_EVENT_INDEX). The index of the first event is 0 and the index of the last event is *number of total events - 1*.
2. Set the current index by performing a **Write Word** on 0xDB (MFR_EVENT_INDEX).
3. Read the event data by performing a **Block Read** on 0xD7 (READ_EVENT). The format of the response data can be seen in the table below.
4. Unless done, choose a new index and continue from **2**.

READ_EVENT response (Block Read 0xD7, 26 bytes):

0	7	8	15	16	23	24	31
Index				V _{in}			
V _{out}				I _{out}			
Temperature				Duty			
STATUS_WORD				STATUS_VOUT		STATUS_IOUT	
STATUS_INPUT		STATUS_TEMPERATURE		STATUS_CML		STATUS_MFR	
Error state	Old state		Ticks byte 4		Ticks byte 0		Ticks byte 1
Ticks byte 2		Ticks byte 3					

TECHNICAL REFERENCE DOCUMENT: SOLDERING

Soldering information—hole mounted through pin-in-paste assembly

The pin-in-paste mount product is intended for forced convection or vapor phase reflow soldering in SnPb and Pb-free process.

Reflow soldering is not preferred for through-hole mounted power modules due to challenges resulting in reduced reliability. High temperature reflow soldering causing IMC layer thickness increase results in shorten solder joint lifetime. To avoid component or solder failure a module peak temperature higher than 245 degrees and above 217 degrees more than 90 seconds is not recommended. To prevent re-melt of module internal solder joints shielding cap is required during reflow process.

A no-clean flux is recommended to avoid entrapment of cleaning fluids in cavities inside the product or between the product and the host board, since cleaning residues may affect long time reliability and isolation voltage.

General reflow process specification		SnPb eutectic	Pb-free
Average temperature (T_{product})		3 °C/s max	3 °C/s max
Typical solder melting temp.	T_L	183 °C	221 °C
Min. Reflow time above T_L	T_{pin}	60 s	60 s
Min. pin temp.	T_{pin}	210 °C	235 °C
Peak product temp.	T_{product}	225 °C	245 °C
Average ramp-down (T_{product})		6°C/s max	6°C/s max
Max. time 25° C to peak		6 minutes	8 minutes

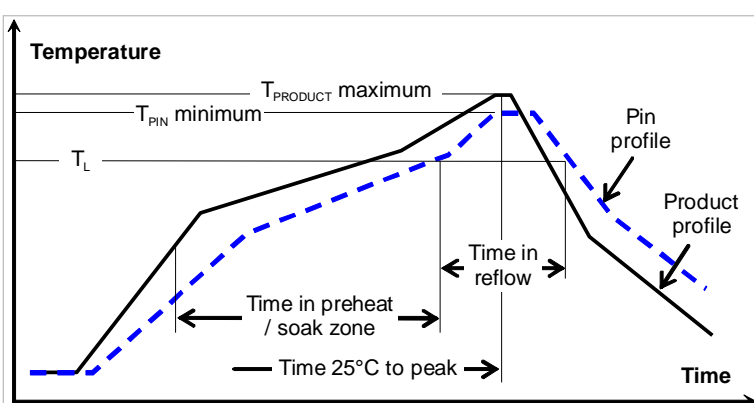

Typical soldering profile

Thermocoupler attachment

T_{PRODUCT} IS MEASURED ON THE BASEPLATE TOP SIDE SINCE THIS WILL LIKELY BE THE WARMEST PART OF THE PRODUCT DURING THE REFLOW PROCESS.

T_{PIN} TEMPERATURE IS MEASURED ON THE POWER MODULE OUTPUT POWER PINS SOLDER JOINTS AT THE CUSTOMER BOARD.

Soldering information - hole mounting

The hole mounted product is intended for plated through hole mounting by wave or manual soldering. The pin temperature is specified to maximum to 270°C for maximum 10 seconds.

A maximum preheat rate of 4°C/s and maximum preheat temperature of 150°C is suggested. When soldering by hand, be careful to avoid direct contact between the hot soldering iron tip and the pins for more than a few seconds in order to prevent overheating.

A no-clean flux is recommended to avoid entrapment of cleaning fluids in cavities inside the product or between the product and the host board. The cleaning residues may affect long time reliability and isolation voltage.

Product reflow classification

The product has been tested for the following:

Pb-free solder classification

For Pb-free solder processes, the product is qualified for MSL 3 according to IPC/JEDEC standard J-STD-020C.

Product reflow processes

Lead-free (Pb-free) solder processes

For Pb-free solder processes, a pin temperature (T_{PIN}) in excess of the solder melting temperature (T_L , 217 to 221°C for SnAgCu solder alloys) for more than 60 seconds and a peak temperature of 245°C on all solder joints is recommended to ensure a reliable solder joint

Dry pack information

Products intended for Pb-free reflow soldering processes are delivered in standard moisture barrier bags according to IPC/JEDEC standard J-STD-033 (handling, packing, shipping and use of moisture/reflow sensitivity surface mount devices).

Using products in high temperature Pb-free soldering processes requires dry pack storage and handling. In case the products have been stored in an uncontrolled environment and no longer can be considered dry, floor life according to MSL 3, the modules must be baked according to J-STD-033.

TECHNICAL REFERENCE DOCUMENT: SAFETY

Safety specifications

Flex Power Modules' DC/DC converters and DC/DC regulators are designed in accordance with the safety standards *IEC 62368-1*, *EN 62368-1* and *UL 62368-1 Audio/video, information and communication technology equipment - Part 1: Safety requirements*

IEC/EN/UL 62368-1 contains requirements to prevent injury or damage due to the following hazards:

- Electrical shock
- Electrically-caused fire
- Injury caused by hazardous substances
- Mechanically-caused injury
- Skin burn
- Radiation-caused injury

On-board DC/DC converters, Power Interface Modules and DC/DC regulators are defined as component power supplies. As components they cannot fully comply with the provisions of any safety requirements without "conditions of acceptability". Clearance between conductors and between conductive parts of the component power supply and conductors on the board in the final product must meet the applicable safety requirements. Certain conditions of acceptability apply for component power supplies with limited stand-off (please refer to *Technical Specification under Mechanical Information* for further information). It is the responsibility of the installer to ensure that the final product housing these components complies with the requirements of all applicable safety standards and regulations for the final product.

Component power supplies for general use shall comply with the requirements in *IEC/EN/UL 62368-1*. Product related standards, e.g. *IEEE 802.3af Power over Ethernet*, and *ETS-300132-2 Power interface at the input to telecom equipment, operated by direct current (dc)* are based on *IEC/EN/UL 62368 -1* with regards to safety.

All Flex Power Modules' DC/DC converters, Power Interface Modules and DC/DC regulators are UL 62368-1 recognized and certified in accordance with *EN 62368-1*. The flammability rating for all construction parts of the products meet requirements for V-0 class material according to *IEC 60695 -11-10*, Fire hazard testing, test flames – 50 W horizontal and vertical flame test methods.

Isolated DC/DC converters

The product may provide basic or functional insulation between input and output according to IEC/EN/UL 62368-1 different conditions shall be met if the output of a basic or a functional insulated product shall be considered as safety extra low voltage (SELV).

For basic insulated products the output is considered as safety extra low voltage (SELV) if one of the following condition is met:

- The input source provides supplementary or double or reinforced insulation from the AC mains according to IEC/EN/UL 62368-1.
- The input source provides functional or basic insulation from the AC mains and the product's output is reliably connected to protective earth according to IEC/EN/UL 62368-1.

For functional insulated products the output is considered as safety extra low voltage (SELV) if one of the following conditions is met:

- The input source provides double or reinforced insulation from the AC mains according to IEC/EN/UL 62368-1.
- The input source provides basic or supplementary insulation from the AC mains and the product's output is reliably connected to protective earth according to IEC/EN/UL 62368-1.
- The input source is reliably connected to protective earth and provides basic or supplementary insulation according to IEC/EN/UL 62368-1 and the maximum input source voltage is 60 Vdc.

Galvanic isolation between input and output is verified in an electric strength test and the isolation (VISO) meets the voltage strength requirements for basic insulation according to IEC/EN/UL 62368-1.

It is recommended to use slow blow fuses at the input of each DC/DC converter. If an input filter is used in the circuit the fuse should be placed in front of the input filter. In the rare event of a component problem that imposes a short circuit on the input source, this fuse will provide the following functions:

- Isolate the fault from the input power source so as not to affect the operation of other parts of the system
- Protect the distribution wiring from excessive current and power loss thus preventing hazardous overheating

Technical Reference PMBus:BMR3502253/803

This appendix contains a detailed reference of the PMBus commands supported by the product.

Data Formats

The products make use of a few standardized numerical formats, along with custom data formats. A detailed walkthrough of the above formats is provided in AN304, as well as in sections 7 and 8 of the PMBus Specification Part II. The custom data formats vary depending on the command, and are detailed in the command description.

Standard Commands

The functionality of commands with code 0x00 to 0xCF is usually based on the corresponding command specification provided in the PMBus Standard Specification Part II (see Power System Management Bus Protocol Documents below). However there might be different interpretations of the PMBus Standard Specification or only parts of the Standard Specification applied, thus the detailed command description below should always be consulted.

Forum Websites

The System Management Interface Forum (SMIF)

<http://www.powersig.org/>

The System Management Interface Forum (SMIF) supports the rapid advancement of an efficient and compatible technology base that promotes power management and systems technology implementations. The SMIF provides a membership path for any company or individual to be active participants in any or all of the various working groups established by the implementer forums.

Power Management Bus Implementers Forum
(PMBUS-IF)

<http://pmbus.org/>

The PMBus-IF supports the advancement and early adoption of the PMBus protocol for power management. This website offers recent PMBus specification documents, PMBus articles, as well as upcoming PMBus presentations and seminars, PMBus Document Review Board (DRB) meeting notes, and other PMBus related news.

PMBus – Power System Management Bus Protocol Documents

These specification documents may be obtained from the PMBus-IF website described above. These are required reading for complete understanding of the PMBus implementation. This appendix will not re-address all of the details contained within the two PMBus Specification documents.

Specification Part I – General Requirements Transport And Electrical Interface

Includes the general requirements, defines the transport and electrical interface and timing requirements of hard wired signals.

Specification Part II – Command Language

Describes the operation of commands, data formats, fault management and defines the command language used with the PMBus.

SMBus – System Management Bus Documents

System Management Bus Specification, Version 2.0, August 3, 2000

This specification specifies the version of the SMBus on which Revision 1.2 of the PMBus Specification is based. This specification is freely available from the System Management Interface Forum Web site at:

<http://www.smbus.org/specs/>

PMBus Command Summary and Factory Default Values of Standard Configuration

The factory default values provided in the table below are valid for the Standard configuration. Factory default values for other configurations can be found using the Flex Power Designer tool.

Code	Name	Data Format	Factory Default Value Standard Configuration BMR350X253/803 R1	Min Set Value	Max Set Value	Unit	
0x01	OPERATION	R/W Byte	0x80				
0x02	ON_OFF_CONFIG	R/W Byte	0x1D				
0x03	CLEAR_FAULTS	Send Byte					
0x12	RESTORE_DEFAULT_ALL	Send Byte					
0x15	STORE_USER_ALL	Send Byte					
0x16	RESTORE_USER_ALL	Send Byte					
0x19	CAPABILITY	Read Byte					
0x1B	SMBALERT_MASK_VOUT (STATUS_VOUT)	SMBAlert Mask	0x00				
0x1B	SMBALERT_MASK_IOUT (STATUS_IOUT)	SMBAlert Mask	0x00				
0x1B	SMBALERT_MASK_INPUT (STATUS_INPUT)	SMBAlert Mask	0x00				
0x1B	SMBALERT_MASK_TEMPERATU RE (STATUS_TEMPERATURE)	SMBAlert Mask	0x00				
0x1B	SMBALERT_MASK_CML (STATUS_CML)	SMBAlert Mask	0x00				
0x1B	SMBALERT_MASK_OTHER (STATUS_OTHER)	SMBAlert Mask	0x00				
0x1B	SMBALERT_MASK_MFR_SPECIFI C (STATUS_MFR_SPECIFIC)	SMBAlert Mask	0x00				
0x20	VOUT_MODE	Read Byte	0x15				
0x21	VOUT_COMMAND	R/W Word	0x619A	12.20	8	13.2	V
0x22	VOUT_TRIM	R/W Word	0x0000	0.00			V
0x23	VOUT_CAL_OFFSET	R/W Word	Unit Specific				
0x24	VOUT_MAX	R/W Word	0x7333	14.40	0	16	V
0x25	VOUT_MARGIN_HIGH	R/W Word	0x699A	13.20	0	16	V
0x26	VOUT_MARGIN_LOW	R/W Word	0x5666	10.80	0	16	V
0x27	VOUT_TRANSITION_RATE	R/W Word	0xE810	2.00			V/ms
0x28	VOUT_DROOP	R/W Word	0xCA80	5.00			mV/ A
0x2B	VOUT_MIN	R/W Word	0x0000	0.00			V
0x32	MAX_DUTY	R/W Word	0xF186	97.50	0	100	%
0x33	FREQUENCY_SWITCH	R/W Word	0x084B	150.00	135	165	kHz
0x35	VIN_ON	R/W Word	0x0025	37.00	30	60	V
0x36	VIN_OFF	R/W Word	0x0020	32.00	30	60	V
0x37	INTERLEAVE	R/W Word	0x0000				
0x39	IOUT_CAL_OFFSET	Read Word	Unit Specific				
0x40	VOUT_OV_FAULT_LIMIT	R/W Word	0x719A	14.20	0	16	V
0x41	VOUT_OV_FAULT_RESPONSE	R/W Byte	0x9E				
0x42	VOUT_OV_WARN_LIMIT	R/W Word	0x7000	14.00	0	16	V
0x43	VOUT_UV_WARN_LIMIT	R/W Word	0x0001	0.00	0	16	V
0x44	VOUT_UV_FAULT_LIMIT	R/W Word	0x0000	0.00	0	16	V
0x45	VOUT_UV_FAULT_RESPONSE	R/W Byte	0x00				
0x46	IOUT_OC_FAULT_LIMIT	R/W Word	0x00BE	190.00	0	255	A
0x47	IOUT_OC_FAULT_RESPONSE	R/W Byte	0xC6				

0xCA	MFR_IOUT_OC_FAST_FAULT_RESPONSE	R/W Byte	0xC6				
0xD0	MFR_IOUT_AVG_OC_FAULT_LIMIT	R/W Word	0x0082	130.00			A
0xD1	MFR_IOUT_OC_FAST_FAULT_LIMIT	R/W Word	0x00CD	205			A
0xD2	MFR_IOUT_AVG_COEFF	R/W Byte	0x24				
0xD7	MFR_READ_EVENT	R/W Block26					
0xDA	MFR_ISHARE_THRESHOLD	R/W Word	0x0000	0.00			A
0xDB	MFR_EVENT_INDEX	R/W Word					
0xDC	MFR_SELECT_TEMPERATURE_SENSOR	R/W Byte	0x01				
0xE0	MFR_FLEX_FIRMWARE_CMD	R/W Block8					
0xE8	MFR_FILTER_COEFF	R/W Block4	0x3C528A28				
0xEA	MFR_IOUT_APC	Read Word	Unit Specific				
0xF9	MFR_MULTI_PIN_CONFIG	R/W Word	0x0206				
0xFC	MFR_ADDED_DROOP_DURING_RAMP	R/W Word	0x9B33	0.10			mV/ A

PMBus Command Details**OPERATION (0x01)**

Description: Sets the desired PMBus enable and margin operations.

Bit	Function	Description	Value	Function	Description
7:6	Enable	Make the device enable or disable.	00	Immediate Off	Disable Immediately without sequencing.
			01	Soft Off	Disable "Softly" with sequencing.
			10	Enable	Enable device to the desired margin state.
5:4	Margin	Select between margin high/low states or nominal output.	00	Nominal	Operate at nominal output voltage.
			01	Margin Low	Operate at margin low voltage set in VOUT_MARGIN_LOW.
			10	Margin High	Operate at margin high voltage set in VOUT_MARGIN_HIGH.
3:2	Act on Fault	Set 10b to act on fault or set to 01b to ignore fault.	01	Ignore Faults	Ignore Faults when in a margined state. The overvoltage/undervoltage warnings and faults are ignored.
			10	Act on Faults	Act on Faults when in a margined state. The device will handle appropriate overvoltage/undervoltage warnings and faults and respond as programmed by the warning limit or fault response command.

ON_OFF_CONFIG (0x02)

Description: Configures how the device is controlled by the CONTROL pin and the PMBus.

Bit	Function	Description	Value	Function	Description
4	Powerup Operation	Sets the default to either operate any time power is present or for the on/off to be controlled by CONTROL pin and serial bus commands.	0	Enable Always	Unit powers up any time power is present regardless of state of the CONTROL pin, taking the RC configuration into account, see command 0xE3.
			1	Enable pin or PMBus	Unit does not power up until commanded by the CONTROL pin and OPERATION command.
3	PMBus Enable Mode	Controls how the unit responds to commands received via the serial bus.	0	Ignore PMBus	Unit ignores the on/off portion of the OPERATION command from serial bus.
			1	Use PMBus	To start, the unit requires that the on/off portion of the OPERATION command is instructing the unit to run.

2	Enable Pin Mode	Controls how the unit responds to the CONTROL pin.	0	Ignore pin	Unit ignores the CONTROL/Enable pin.
			1	Use pin	Unit requires the CONTROL pin to be asserted to start the unit.
1	Enable Pin Polarity	Polarity of the CONTROL pin.	0	Active High	Enable pin will cause device to enable when driven high.
			1	Active Low	Enable pin will cause device to enable when driven low.
0	Disable Action	CONTROL pin action when commanding the unit to turn off.	0	Soft Off	Use the programmed turn off delay and fall time.
			1	Imm. Off	Turn off the output and stop transferring energy to the output as fast as possible. The device's product literature shall specify whether or not the device sinks current to decrease the output voltage fall time.

CLEAR_FAULTS (0x03)

Description: Clears all fault status bits

RESTORE_DEFAULT_ALL (0x12)

Description: Commands the device to restore its configuration from the Default Store.

STORE_USER_ALL (0x15)

Description: Stores, at the USER level, all PMBus values that were changed since the last restore command.

RESTORE_USER_ALL (0x16)

Description: Restores PMBus settings that were stored using STORE_USER_ALL. This command is automatically performed at power up.

CAPABILITY (0x19)

Description: This command provides a way for a host system to determine some key capabilities of a PMBus device.

Bit	Function	Description	Value	Function	Description
7	Packet Error Checking	Packet error checking.	00	Not Supported	Packet Error Checking not supported.
			01	Supported	Packet Error Checking is supported.
6:5	Maximum Bus Speed	Maximum bus speed.	00	100kHz	Maximum supported bus speed is 100 kHz.
			01	400kHz	Maximum supported bus speed is 400 kHz.
			10	1MHz	Maximum supported bus speed is 1 MHz.
4	Smbalert	SMBALERT	00	No Smbalert	The device does not have a SMBALERT# pin and does not support the SMBus Alert Response protocol.
			01	Have Smbalert	The device does have a SMBALERT# pin and does support the SMBus Alert Response protocol.

3	Numeric Format	Numeric format.	0	LINEAR or DIRECT Format	Numeric data is in LINEAR or DIRECT format.
			1	IEEE Half Precision Floating Point Format	Numeric data is in IEEE half precision floating point format.
2	AVSBus Support	AVSBus support.	0	AVSBus Not Supported	AVSBus not supported.
			1	AVSBus Supported	AVSBus supported.

SMBALERT_MASK_VOUT (0x1B)

Status Registers: STATUS_VOUT (0x7A)

Description: SMBALERT_MASK bits for the STATUS_VOUT command. The SMBALERT_MASK command may be used to prevent a warning or fault condition from asserting the SALERT output signal.

Bit	Function	Description	Value	Function	Description
7	Vout Overvoltage Fault		0	Pull SALERT	
			1	Ignore	
6	Vout Overvoltage Warning		0	Pull SALERT	
			1	Ignore	
5	Vout Undervoltage Warning		0	Pull SALERT	
			1	Ignore	
4	Vout Undervoltage Fault		0	Pull SALERT	
			1	Ignore	
3	Vout Max Warning		0	Pull SALERT	
			1	Ignore	
2	Ton Max Fault		0	Pull SALERT	
			1	Ignore	
1	Toff Max Warning		0	Pull SALERT	
			1	Ignore	

SMBALERT_MASK_IOUT (0x1B)

Status Registers: STATUS_IOUT (0x7B)

Description: SMBALERT_MASK bits for the STATUS_IOUT command. The SMBALERT_MASK command may be used to prevent a warning or fault condition from asserting the SALERT output signal.

Bit	Function	Description	Value	Function	Description
7	Iout Overcurrent Fault		0	Pull SALERT	
			1	Ignore	
6	Iout Overcurrent And Low Voltage Fault		0	Pull SALERT	
			1	Ignore	
5	Iout Over Current Warning		0	Pull SALERT	
			1	Ignore	
4	Iout Undercurrent Fault		0	Pull SALERT	
			1	Ignore	

SMBALERT_MASK_INPUT (0x1B)

Status Registers: STATUS_INPUT (0x7C)

Description: SMBALERT_MASK bits for the STATUS_INPUT command. The SMBALERT_MASK command may be used to prevent a warning or fault condition from asserting the SALERT output signal.

Bit	Function	Description	Value	Function	Description
7	Vin Overvoltage Fault		0	Pull SALERT	
			1	Ignore	
6	Vin Overvoltage Warning		0	Pull SALERT	
			1	Ignore	
5	Vin Undervoltage Warning		0	Pull SALERT	
			1	Ignore	
4	Vin Undervoltage Fault		0	Pull SALERT	
			1	Ignore	
3	Insufficient Vin		0	Pull SALERT	
			1	Ignore	

SMBALERT_MASK_TEMPERATURE (0x1B)

Status Registers: STATUS_TEMPERATURE (0x7D)

Description: SMBALERT_MASK bits for the STATUS_TEMPERATURE command. The SMBALERT_MASK command may be used to prevent a warning or fault condition from asserting the SALERT output signal.

Bit	Function	Description	Value	Function	Description
7	Overtempera ture Fault		0	Pull SALERT	
			1	Ignore	
6	Overtempera ture Warning		0	Pull SALERT	
			1	Ignore	
5	Undertemper ature Warning		0	Pull SALERT	
			1	Ignore	
4	Undertemper ature Fault		0	Pull SALERT	
			1	Ignore	

SMBALERT_MASK_CML (0x1B)

Status Registers: STATUS_CML (0x7E)

Description: SMBALERT_MASK bits for the STATUS_CML command. The SMBALERT_MASK command may be used to prevent a warning or fault condition from asserting the SALERT output signal.

Bit	Function	Description	Value	Function	Description
7	Invalid Or Unsupported Command Received		0	Pull SALERT	
			1	Ignore	
6	Invalid Or Unsupported Data Received		0	Pull SALERT	
			1	Ignore	
5	Packet Error Check Failed		0	Pull SALERT	
			1	Ignore	
4	Memory Fault Detected		0	Pull SALERT	
			1	Ignore	

3	Processor Fault Detected		0	Pull SALERT	
			1	Ignore	
1	Other Communication Fault		0	Pull SALERT	
			1	Ignore	
0	Memory Or Logic Fault		0	Pull SALERT	
			1	Ignore	

SMBALERT_MASK_OTHER (0x1B)

Status Registers: STATUS_OTHER (0x7F)

Description: SMBALERT_MASK bits for the STATUS_OTHER command. The SMBALERT_MASK command may be used to prevent a warning or fault condition from asserting the SALERT output signal.

Bit	Description	Value	Function	Description
0		0	Pull SALERT	
		1	Ignore	

SMBALERT_MASK_MFR_SPECIFIC (0x1B)

Status Registers: STATUS_MFR_SPECIFIC (0x80)

Description: SMBALERT_MASK bits for the STATUS_MFR_SPECIFIC command. The SMBALERT_MASK command may be used to prevent a warning or fault condition from asserting the SALERT output signal.

Bit	Function	Description	Value	Function	Description
7	Sync Fault		0	Pull SALERT	
			1	Ignore	
6	Iout Average Overcurrent Fault		0	Pull SALERT	
			1	Ignore	
5	Iout Fast Overcurrent Fault		0	Pull SALERT	
			1	Ignore	
4	Short Circuit Protection Fault		0	Pull SALERT	
			1	Ignore	

VOUT_MODE (0x20)

Description: Controls how future VOUT-related commands parameters will be interpreted.

Bit	Function	Description	Format
4:0		Five bit two's complement EXPONENT for the MANTISSA delivered as the data bytes for VOUT_COMMAND in VOUT_LINEAR Mode, five bit VID code identifier per in VID Mode or always set to 00000b in Direct Mode.	Integer Signed

Bit	Function	Description	Value	Function	Description
7:5		Set to 000b to select VOUT_LINEAR Mode (Five bit two's complement exponent for the MANTISSA delivered as the data bytes for an output voltage related command), set to 001b to select VID Mode (Five bit VID code identifier per) or set to 010b to select Direct Mode (Always set to 00000b).	000	Linear	Linear Mode Format.
			001	VID	VID Mode.
			010	Direct	Direct Mode.

VOUT_COMMAND (0x21)

Description: Commands the device to transition to a new output voltage.

Bit	Description	Format	Unit
15:0	Sets the nominal value of the output voltage.	Vout Mode Unsigned (Exp = -11)	V

VOUT_TRIM (0x22)

Description: Configures a fixed offset to be applied to the output voltage when enabled.

Bit	Description	Format	Unit
15:0	Sets VOUT trim value. The two bytes are formatted as a two's complement binary mantissa, used in conjunction with the exponent set in VOUT_MODE.	Vout Mode Signed (Exp = -11)	V

VOUT_CAL_OFFSET (0x23)

Description: Vout calibration value. It is a signed number in Vout linear mode. The setting will be applied output voltage.

Bit	Description	Format	Unit
15:0	Vout calibration value. It is a signed number in Vout linear mode. The setting will be applied output voltage.	Vout Mode Signed (Exp = -11)	V

VOUT_MAX (0x24)

Description: Configures the maximum allowed output voltage.

Bit	Description	Format	Unit
15:0	Sets the maximum possible value setting of VOUT. The maximum VOUT_MAX setting is 110% of the pin-strap setting.	Vout Mode Unsigned (Exp = -11)	V

VOUT_MARGIN_HIGH (0x25)

Description: Configures the target for margin-up commands.

Bit	Description	Format	Unit
15:0	Sets the value of the VOUT during a margin high.	Vout Mode Unsigned (Exp = -11)	V

VOUT_MARGIN_LOW (0x26)

Description: Configures the target for margin-down commands.

Bit	Description	Format	Unit
15:0	Sets the value of the VOUT during a margin low.	Vout Mode Unsigned (Exp = -11)	V

VOUT_TRANSITION_RATE (0x27)

Description: Configures the transition time for margins and VCOMMAND output changes.

Bit	Description	Format	Unit
15:0	Sets the transition rate during margin or other change of VOUT.	Linear	V/ms

VOUT_DROOP (0x28)

Description: Configures the Isense voltage to load current ratio.

Bit	Description	Format	Unit
15:0	Sets the effective load line (V/I slope) for the device.	Linear	mV/A

VOUT_MIN (0x2B)

Description: This command is used to limit the minimum output voltage, irrespective of whatever voltage is commanded by a combination of VOUT_COMMAND (or VOUT_MARGIN_HIGH or VOUT_MARGIN_LOW) and VOUT_TRIM. The intent of this command is to provide a safeguard against a user accidentally setting the output voltage to a possibly destructive level rather than to be the primary output overprotection. The exponent is set by VOUT_MODE. If an attempt is made to program the output voltage lower than the limit set by this command, this will flag a WARNING condition, but NOT a fault.

Bit	Description	Format	Unit
15:0	This command is used to limit the minimum output voltage	Vout Mode Unsigned (Exp = -11)	V

MAX_DUTY (0x32)

Description: Configures the maximum allowed duty-cycle.

Bit	Description	Format	Unit
15:0	Sets the maximum allowable duty cycle of the switching frequency.	Linear	%

FREQUENCY_SWITCH (0x33)

Description: Controls the switching frequency in 1kHz steps.

Bit	Description	Format	Unit
15:0	Sets the switching frequency.	Linear	kHz

VIN_ON (0x35)

Description: The VIN_ON command sets the value of the input voltage, in volts, at which the unit should start power conversion.

Bit	Description	Format	Unit
15:0	Sets the VIN ON threshold.	Linear	V

VIN_OFF (0x36)

Description: The VIN_OFF command sets the value of the input voltage, in volts, at which the unit, once operation has started, should stop power conversion.

Bit	Description	Format	Unit
15:0	Sets the VIN OFF threshold.	Linear	V

INTERLEAVE (0x37)

Description: Configures the phase offset with respect to a common SYNC clock. When multiple products share a common DC input supply, spreading of the switching phases between the products can be utilized. This reduces the input capacitance requirements and efficiency losses, since the peak current drawn from the input supply is effectively spread out over the whole switch period. If two or more units have their outputs connected in parallel, interleaving will reduce ripple currents. This requires that the products are synchronized using the SYNC pin.

Bit	Function	Description	Format
11:8	Group ID Number	Value 0-15. Sets an ID number to a group of interleaved rails.	Integer Unsigned
7:4	Number of Rails	Value 0-15. Sets the number of units in the group, including the SYNC OUT product.	Integer Unsigned
3:0	Rail Position	Value 0-15. Sets the interleave order for this unit. The product configured to SYNC OUT shall be assigned to number 0	Integer Unsigned

IOUT_CAL_OFFSET (0x39)

Description: Sets the current-sense offset.

Bit	Description	Format	Unit
15:0	Sets an offset to IOUT readings. Use to compensate for delayed measurements of current ramp.	Linear	A

VOUT_OV_FAULT_LIMIT (0x40)

Description: Output over voltage fault limit.

Bit	Description	Format	Unit
15:0	Output over voltage fault limit.	Vout Mode Unsigned (Exp = -11)	V

VOUT_OV_FAULT_RESPONSE (0x41)

Description: Output over voltage fault response.

Bit	Function	Description	Value	Function	Description
7:6	Response		00	Ignore Fault	The PMBus device continues operation without interruption.
			01	Perform Retries while Operating	The PMBus device continues operation for the delay time specified by bits [2:0] and the delay time unit specified for that particular fault. If the fault condition is still present at the end of the delay time, the unit responds as programmed in the Retry Setting (bits [5:3]).
			10	Disable and retry	The device shuts down (disables the output) and responds according to the retry setting in bits [5:3].

		Describes the device interruption operation. 00b - The PMBus device continues operation without interruption. 01b - The PMBus device continues operation for the delay time specified by bits [2:0] and the delay time unit specified for that particular fault. If the fault condition is still present at the end of the delay time, the unit responds as programmed in the Retry Setting (bits [5:3]). 10b - The device shuts down (disables the output) and responds according to the Retry Setting in bits [5:3]. 11b - The device's output is disabled while the fault is present. Operation resumes and the output is enabled when the fault condition no longer exists.	11	Disable until Fault Cleared	A fault can be cleared in several ways: The bit is individually cleared, The device receives a CLEAR_FAULTS command, a RESET signal (if one exists) is asserted, the output is commanded through the CTRL pin, the OPERATION command, or the combined action of the CTRL pin and OPERATION command, to turn off and then to turn back on, or Bias power is removed from the PMBus device.
5:3	Retries	The device attempts to restart the number of times set by these bits. 000b means the device does not attempt a restart. 111b means the device attempts restarting continuously.	000	Do Not Retry	A zero value for the Retry Setting means that the unit does not attempt to restart. The output remains disabled until the fault is cleared (Section 10.7).
			001	Retry Once	The PMBus device attempts to restart 1 time. If the device fails to restart, it disables the output and remains off until the fault is cleared as described in Section 10.7. The time between the start of each attempt to restart is set by the value in bits [2:] along with the delay time unit specified for that particular fault.
			010	Retry Twice	The PMBus device attempts to restart 2 times. If the device fails to restart, it disables the output and remains off until the fault is cleared as described in Section 10.7. The time between the start of each attempt to restart is set by the value in bits [2:] along with the delay time unit specified for that particular fault.

			011	Retry 3 times	The PMBus device attempts to restart 3 times. If the device fails to restart, it disables the output and remains off until the fault is cleared as described in Section 10.7. The time between the start of each attempt to restart is set by the value in bits [2:] along with the delay time unit specified for that particular fault.
			100	Retry 4 times	The PMBus device attempts to restart 4 times. If the device fails to restart, it disables the output and remains off until the fault is cleared as described in Section 10.7. The time between the start of each attempt to restart is set by the value in bits [2:] along with the delay time unit specified for that particular fault.
			101	Retry 5 times	The PMBus device attempts to restart 5 times. If the device fails to restart, it disables the output and remains off until the fault is cleared as described in Section 10.7. The time between the start of each attempt to restart is set by the value in bits [2:] along with the delay time unit specified for that particular fault.
			110	Retry 6 times	The PMBus device attempts to restart 6 times. If the device fails to restart, it disables the output and remains off until the fault is cleared as described in Section 10.7. The time between the start of each attempt to restart is set by the value in bits [2:] along with the delay time unit specified for that particular fault.
			111	Retry Continuously	The PMBus device attempts to restart continuously, without limitation, until it is commanded OFF (by the CONTROL pin or OPERATION command or both), bias power is removed, or another fault condition causes the unit to shut down.

2:0	Retry Time and Delay Time	Number of delay time units. Used for either the amount of time the device is to continue operating after a fault is detected or for the amount of time between attempts to restart. The time unit is set in register 0xC8.	0	1	
			1	2	
			2	4	
			3	8	
			4	16	
			5	32	
			6	64	
			7	128	

VOUT_OV_WARN_LIMIT (0x42)

Description: Output over voltage warning limit.

Bit	Description	Format	Unit
15:0	Output over voltage warning limit.	Vout Mode Unsigned (Exp = -11)	V

VOUT_UV_WARN_LIMIT (0x43)

Description: Output under voltage warning limit.

Bit	Description	Format	Unit
15:0	Output under voltage warning limit.	Vout Mode Unsigned (Exp = -11)	V

VOUT_UV_FAULT_LIMIT (0x44)

Description: Output under voltage fault limit.

Bit	Description	Format	Unit
15:0	Output under voltage fault limit.	Vout Mode Unsigned (Exp = -11)	V

VOUT_UV_FAULT_RESPONSE (0x45)

Description: Output under voltage fault response.

Bit	Function	Description	Value	Function	Description
7:6	Response		00	Ignore Fault	The PMBus device continues operation without interruption.
			01	Perform Retries while Operating	The PMBus device continues operation for the delay time specified by bits [2:0] and the delay time unit specified for that particular fault. If the fault condition is still present at the end of the delay time, the unit responds as programmed in the Retry Setting (bits [5:3]).

		<p>Describes the device interruption operation. 00b - The PMBus device continues operation without interruption. 01b - The PMBus device continues operation for the delay time specified by bits [2:0] and the delay time unit specified for that particular fault. If the fault condition is still present at the end of the delay time, the unit responds as programmed in the Retry Setting (bits [5:3]). 10b - The device shuts down (disables the output) and responds according to the Retry Setting in bits [5:3]. 11b - The device's output is disabled while the fault is present. Operation resumes and the output is enabled when the fault condition no longer exists.</p>	10	Disable and retry	The device shuts down (disables the output) and responds according to the retry setting in bits [5:3].
			11	Disable until Fault Cleared	A fault can be cleared in several ways: The bit is individually cleared, The device receives a CLEAR_FAULTS command, a RESET signal (if one exists) is asserted, the output is commanded through the CTRL pin, the OPERATION command, or the combined action of the CTRL pin and OPERATION command, to turn off and then to turn back on, or Bias power is removed from the PMBus device.
5:3	Retries	<p>The device attempts to restart the number of times set by these bits. 000b means the device does not attempt a restart. 111b means the device attempts restarting continuously.</p>	000	Do Not Retry	A zero value for the Retry Setting means that the unit does not attempt to restart. The output remains disabled until the fault is cleared (Section 10.7).
			001	Retry Once	The PMBus device attempts to restart 1 time. If the device fails to restart, it disables the output and remains off until the fault is cleared as described in Section 10.7. The time between the start of each attempt to restart is set by the value in bits [2:] along with the delay time unit specified for that particular fault.
			010	Retry Twice	The PMBus device attempts to restart 2 times. If the device fails to restart, it disables the output and remains off until the fault is cleared as described in Section 10.7. The time between the start of each attempt to restart is set by the value in bits [2:] along with the delay time unit specified for that particular fault.

			011	Retry 3 times	The PMBus device attempts to restart 3 times. If the device fails to restart, it disables the output and remains off until the fault is cleared as described in Section 10.7. The time between the start of each attempt to restart is set by the value in bits [2:] along with the delay time unit specified for that particular fault.
			100	Retry 4 times	The PMBus device attempts to restart 4 times. If the device fails to restart, it disables the output and remains off until the fault is cleared as described in Section 10.7. The time between the start of each attempt to restart is set by the value in bits [2:] along with the delay time unit specified for that particular fault.
			101	Retry 5 times	The PMBus device attempts to restart 5 times. If the device fails to restart, it disables the output and remains off until the fault is cleared as described in Section 10.7. The time between the start of each attempt to restart is set by the value in bits [2:] along with the delay time unit specified for that particular fault.
			110	Retry 6 times	The PMBus device attempts to restart 6 times. If the device fails to restart, it disables the output and remains off until the fault is cleared as described in Section 10.7. The time between the start of each attempt to restart is set by the value in bits [2:] along with the delay time unit specified for that particular fault.
			111	Retry Continuously	The PMBus device attempts to restart continuously, without limitation, until it is commanded OFF (by the CONTROL pin or OPERATION command or both), bias power is removed, or another fault condition causes the unit to shut down.

2:0	Retry Time and Delay Time	Number of delay time units. Used for either the amount of time the device is to continue operating after a fault is detected or for the amount of time between attempts to restart. The time unit is set in register 0xC8.	0	1	
			1	2	
			2	4	
			3	8	
			4	16	
			5	32	
			6	64	
			7	128	

IOUT_OC_FAULT_LIMIT (0x46)

Description: Output over current limit.

Bit	Description	Format	Unit
15:0	Output over current fault limit.	Linear	A

IOUT_OC_FAULT_RESPONSE (0x47)

Description: Output over current fault response.

Bit	Function	Description	Value	Function	Description
7:6	Response	For all values of bits [7:6], the device: Sets the corresponding fault bit in the status registers and If the device supports notifying the host, it does so.	00	Ignore Fault	The PMBus device continues to operate indefinitely while maintaining the output current at the value set by IOUT_OC_FAULT_LIMIT without regard to the output voltage (known as constant-current or brickwall limiting).
			01	Conditioned constant current	The PMBus device continues to operate indefinitely while maintaining the output current at the value set by IOUT_OC_FAULT_LIMIT as long as the output voltage remains above the minimum value specified by IOUT_OC_LV_FAULT_LIMIT. If the output voltage is pulled down to less than that value, then the PMBus device shuts down and responds according to the Retry setting in bits [5:3].
			10	Delay w/ Const. Current & Retry	The PMBus device continues to operate, maintaining the output current at the value set by IOUT_OC_FAULT_LIMIT without regard to the output voltage, for the delay time set by bits [2:0] and the delay time units for specified in the IOUT_OC_FAULT_RESPONSE. If the device is still operating in current limiting at the end of the delay time, the device responds as programmed by the Retry Setting in bits [5:3].

			11	Disable and Retry	The PMBus device shuts down and responds as programmed by the Retry Setting in bits [5:3].
5:3	Retries	The device attempts to restart the number of times set by these bits. 000b means the device does not attempt a restart. 111b means the device attempts restarting continuously.	000	Do Not Retry	A zero value for the Retry Setting means that the unit does not attempt to restart. The output remains disabled until the fault is cleared (Section 10.7).
			001	Retry Once	The PMBus device attempts to restart 1 time. If the device fails to restart, it disables the output and remains off until the fault is cleared as described in Section 10.7. The time between the start of each attempt to restart is set by the value in bits [2:] along with the delay time unit specified for that particular fault.
			010	Retry Twice	The PMBus device attempts to restart 2 times. If the device fails to restart, it disables the output and remains off until the fault is cleared as described in Section 10.7. The time between the start of each attempt to restart is set by the value in bits [2:] along with the delay time unit specified for that particular fault.
			011	Retry 3 times	The PMBus device attempts to restart 3 times. If the device fails to restart, it disables the output and remains off until the fault is cleared as described in Section 10.7. The time between the start of each attempt to restart is set by the value in bits [2:] along with the delay time unit specified for that particular fault.

			100	Retry 4 times	The PMBus device attempts to restart 4 times. If the device fails to restart, it disables the output and remains off until the fault is cleared as described in Section 10.7. The time between the start of each attempt to restart is set by the value in bits [2:] along with the delay time unit specified for that particular fault.
			101	Retry 5 times	The PMBus device attempts to restart 5 times. If the device fails to restart, it disables the output and remains off until the fault is cleared as described in Section 10.7. The time between the start of each attempt to restart is set by the value in bits [2:] along with the delay time unit specified for that particular fault.
			110	Retry 6 times	The PMBus device attempts to restart 6 times. If the device fails to restart, it disables the output and remains off until the fault is cleared as described in Section 10.7. The time between the start of each attempt to restart is set by the value in bits [2:] along with the delay time unit specified for that particular fault.
			111	Retry Continuously	The PMBus device attempts to restart continuously, without limitation, until it is commanded OFF (by the CONTROL pin or OPERATION command or both), bias power is removed, or another fault condition causes the unit to shut down.
2:0	Retry Time and Delay Time	Number of delay time units. Used for either the amount of time the device is to continue operating after a fault is detected or for the amount of time between attempts to restart. The time unit is set in register 0xC8.	0	1	
			1	2	
			2	4	
			3	8	
			4	16	
			5	32	
			6	64	
			7	128	

IOUT_OC_LV_FAULT_LIMIT (0x48)

Description: Set the output over-current low-voltage fault threshold.

Bit	Description	Format	Unit
15:0	Set the output over-current low-voltage fault threshold.	Vout Mode Unsigned (Exp = -11)	V

IOUT_OC_WARN_LIMIT (0x4A)

Description: Output over current warning limit.

Bit	Description	Format	Unit
15:0	Output over current warning limit.	Linear	A

IOUT_UC_FAULT_LIMIT (0x4B)

Description: Sets the output under-current peak limit.

Bit	Description	Format	Unit
15:0	Sets the IOUT under-current peak fault threshold.	Linear	A

IOUT_UC_FAULT_RESPONSE (0x4C)

Description: Configures the output undercurrent fault response. The command format is the same as the PMBus standard responses for voltage and temperature faults except that it sets the undercurrent status bit.

Bit	Function	Description	Value	Function	Description
7:6	Response	Describes the device interruption operation. For all modes set by bits [7:6], the device pulls SALERT low and sets the related fault bit in the status registers.	00	Ignore Fault	The PMBus device continues operation without interruption.
			01	Perform Retries while Operating	The PMBus device continues operation for the delay time specified by bits [2:0] and the delay time unit specified for that particular fault. If the fault condition is still present at the end of the delay time, the unit responds as programmed in the Retry Setting (bits [5:3]).
			10	Disable and Retry	The device shuts down (disables the output) and responds according to the retry setting in bits [5:3].
			11	Disable until clear	The device's output is disabled while the fault is present. Operation resumes and the output is enabled when the fault condition no longer exists.
5:3	Retry Setting	The device attempts to restart the number of times set by these bits.	000	Do Not Retry	A zero value for the Retry Setting means that the unit does not attempt to restart. The output remains disabled until the fault is cleared.

			001	Retry Once	The PMBus device attempts to restart 1 time. If the device fails to restart, it disables the output and remains off until the fault is cleared. The time between the start of each attempt to restart is set by the value in bits [2:0] along with the delay time unit specified for that particular fault.
			010	Retry Twice	The PMBus device attempts to restart 2 times.
			011	Retry 3 times	The PMBus device attempts to restart 3 times.
			100	Retry 4 times	The PMBus device attempts to restart 4 times.
			101	Retry 5 times	The PMBus device attempts to restart 5 times.
			110	Retry 6 times	The PMBus device attempts to restart 6 times.
			111	Retry Continuously	The PMBus device attempts to restart continuously, without limitation, until output is DISABLED, bias power is removed, or another fault condition causes the output to shut down.
2:0	Retry Time and Delay Time	Number of delay time units. Used for either the amount of time the device (10 ms/unit) is to continue operating after a fault is detected or for the amount of time (8.2 ms/unit) between attempts to restart.	0	0	
			1	1	
			2	2	
			3	3	
			4	4	
			5	5	
			6	6	
			7	7	

OT_FAULT_LIMIT (0x4F)

Description: Over temperature fault limit.

Bit	Description	Format	Unit
15:0	Over temperature fault limit.	Linear	°C

OT_FAULT_RESPONSE (0x50)

Description: Over temperature fault response.

Bit	Function	Description	Value	Function	Description
7:6	Response		00	Ignore Fault	The PMBus device continues operation without interruption.

			01	Perform Retries while Operating	The PMBus device continues operation for the delay time specified by bits [2:0] and the delay time unit specified for that particular fault. If the fault condition is still present at the end of the delay time, the unit responds as programmed in the Retry Setting (bits [5:3]).
			10	Disable and retry	The device shuts down (disables the output) and responds according to the retry setting in bits [5:3].
			11	Disable until Fault Cleared	A fault can be cleared in several ways: The bit is individually cleared, The device receives a CLEAR_FAULTS command, a RESET signal (if one exists) is asserted, the output is commanded through the CTRL pin, the OPERATION command, or the combined action of the CTRL pin and OPERATION command, to turn off and then to turn back on, or Bias power is removed from the PMBus device.
5:3	Retries		000	Do Not Retry	A zero value for the Retry Setting means that the unit does not attempt to restart. The output remains disabled until the fault is cleared (Section 10.7).
			001	Retry Once	The PMBus device attempts to restart 1 time. If the device fails to restart, it disables the output and remains off until the fault is cleared as described in Section 10.7. The time between the start of each attempt to restart is set by the value in bits [2:] along with the delay time unit specified for that particular fault.

			010	Retry Twice	The PMBus device attempts to restart 2 times. If the device fails to restart, it disables the output and remains off until the fault is cleared as described in Section 10.7. The time between the start of each attempt to restart is set by the value in bits [2:] along with the delay time unit specified for that particular fault.
			011	Retry 3 times	The PMBus device attempts to restart 3 times. If the device fails to restart, it disables the output and remains off until the fault is cleared as described in Section 10.7. The time between the start of each attempt to restart is set by the value in bits [2:] along with the delay time unit specified for that particular fault.
			100	Retry 4 times	The PMBus device attempts to restart 4 times. If the device fails to restart, it disables the output and remains off until the fault is cleared as described in Section 10.7. The time between the start of each attempt to restart is set by the value in bits [2:] along with the delay time unit specified for that particular fault.
			101	Retry 5 times	The PMBus device attempts to restart 5 times. If the device fails to restart, it disables the output and remains off until the fault is cleared as described in Section 10.7. The time between the start of each attempt to restart is set by the value in bits [2:] along with the delay time unit specified for that particular fault.

			110	Retry 6 times	The PMBus device attempts to restart 6 times. If the device fails to restart, it disables the output and remains off until the fault is cleared as described in Section 10.7. The time between the start of each attempt to restart is set by the value in bits [2:] along with the delay time unit specified for that particular fault.
			111	Retry Continuously	The PMBus device attempts to restart continuously, without limitation, until it is commanded OFF (by the CONTROL pin or OPERATION command or both), bias power is removed, or another fault condition causes the unit to shut down.
2:0	Retry Time and Delay Time	Number of delay time units. Used for either the amount of time the device is to continue operating after a fault is detected or for the amount of time between attempts to restart. The time unit is set in register 0xC8.	0	1	
			1	2	
			2	4	
			3	8	
			4	16	
			5	32	
			6	64	
			7	128	

OT_WARN_LIMIT (0x51)

Description: Over temperature warning limit.

Bit	Description	Format	Unit
15:0	Over temperature warning limit.	Linear	°C

UT_WARN_LIMIT (0x52)

Description: Under temperature warning limit.

Bit	Description	Format	Unit
15:0	Under temperature warning limit.	Linear	°C

UT_FAULT_LIMIT (0x53)

Description: Under temperature fault limit.

Bit	Description	Format	Unit
15:0	Under temperature fault limit.	Linear	°C

UT_FAULT_RESPONSE (0x54)

Description: Under temperature fault response.

Bit	Function	Description	Value	Function	Description
7:6	Response		00	Ignore Fault	The PMBus device continues operation without interruption.

			01	Perform Retries while Operating	The PMBus device continues operation for the delay time specified by bits [2:0] and the delay time unit specified for that particular fault. If the fault condition is still present at the end of the delay time, the unit responds as programmed in the Retry Setting (bits [5:3]).
			10	Disable and retry	The device shuts down (disables the output) and responds according to the retry setting in bits [5:3].
			11	Disable until Fault Cleared	A fault can be cleared in several ways: The bit is individually cleared, The device receives a CLEAR_FAULTS command, a RESET signal (if one exists) is asserted, the output is commanded through the CTRL pin, the OPERATION command, or the combined action of the CTRL pin and OPERATION command, to turn off and then to turn back on, or Bias power is removed from the PMBus device.
5:3	Retries		000	Do Not Retry	A zero value for the Retry Setting means that the unit does not attempt to restart. The output remains disabled until the fault is cleared (Section 10.7).
			001	Retry Once	The PMBus device attempts to restart 1 time. If the device fails to restart, it disables the output and remains off until the fault is cleared as described in Section 10.7. The time between the start of each attempt to restart is set by the value in bits [2:] along with the delay time unit specified for that particular fault.

			010	Retry Twice	The PMBus device attempts to restart 2 times. If the device fails to restart, it disables the output and remains off until the fault is cleared as described in Section 10.7. The time between the start of each attempt to restart is set by the value in bits [2:] along with the delay time unit specified for that particular fault.
			011	Retry 3 times	The PMBus device attempts to restart 3 times. If the device fails to restart, it disables the output and remains off until the fault is cleared as described in Section 10.7. The time between the start of each attempt to restart is set by the value in bits [2:] along with the delay time unit specified for that particular fault.
			100	Retry 4 times	The PMBus device attempts to restart 4 times. If the device fails to restart, it disables the output and remains off until the fault is cleared as described in Section 10.7. The time between the start of each attempt to restart is set by the value in bits [2:] along with the delay time unit specified for that particular fault.
			101	Retry 5 times	The PMBus device attempts to restart 5 times. If the device fails to restart, it disables the output and remains off until the fault is cleared as described in Section 10.7. The time between the start of each attempt to restart is set by the value in bits [2:] along with the delay time unit specified for that particular fault.

			110	Retry 6 times	The PMBus device attempts to restart 6 times. If the device fails to restart, it disables the output and remains off until the fault is cleared as described in Section 10.7. The time between the start of each attempt to restart is set by the value in bits [2:] along with the delay time unit specified for that particular fault.
			111	Retry Continuously	The PMBus device attempts to restart continuously, without limitation, until it is commanded OFF (by the CONTROL pin or OPERATION command or both), bias power is removed, or another fault condition causes the unit to shut down.
2:0	Retry Time and Delay Time	Number of delay time units. Used for either the amount of time the device is to continue operating after a fault is detected or for the amount of time between attempts to restart. The time unit is set in register 0xC8.	0	1	
			1	2	
			2	4	
			3	8	
			4	16	
			5	32	
			6	64	
			7	128	

VIN_OV_FAULT_LIMIT (0x55)

Description: Input over voltage fault limit.

Bit	Description	Format	Unit
15:0	Input over voltage fault limit.	Linear	V

VIN_OV_FAULT_RESPONSE (0x56)

Description: Input over voltage fault response.

Bit	Function	Description	Value	Function	Description
7:6	Response		00	Ignore Fault	The PMBus device continues operation without interruption.
			01	Perform Retries while Operating	The PMBus device continues operation for the delay time specified by bits [2:0] and the delay time unit specified for that particular fault. If the fault condition is still present at the end of the delay time, the unit responds as programmed in the Retry Setting (bits [5:3]).

			10	Disable and retry	The device shuts down (disables the output) and responds according to the retry setting in bits [5:3].
			11	Disable until Fault Cleared	A fault can be cleared in several ways: The bit is individually cleared, The device receives a CLEAR_FAULTS command, a RESET signal (if one exists) is asserted, the output is commanded through the CTRL pin, the OPERATION command, or the combined action of the CTRL pin and OPERATION command, to turn off and then to turn back on, or Bias power is removed from the PMBus device.
5:3	Retries		000	Do Not Retry	A zero value for the Retry Setting means that the unit does not attempt to restart. The output remains disabled until the fault is cleared (Section 10.7).
			001	Retry Once	The PMBus device attempts to restart 1 time. If the device fails to restart, it disables the output and remains off until the fault is cleared as described in Section 10.7. The time between the start of each attempt to restart is set by the value in bits [2:] along with the delay time unit specified for that particular fault.
			010	Retry Twice	The PMBus device attempts to restart 2 times. If the device fails to restart, it disables the output and remains off until the fault is cleared as described in Section 10.7. The time between the start of each attempt to restart is set by the value in bits [2:] along with the delay time unit specified for that particular fault.

			011	Retry 3 times	The PMBus device attempts to restart 3 times. If the device fails to restart, it disables the output and remains off until the fault is cleared as described in Section 10.7. The time between the start of each attempt to restart is set by the value in bits [2:] along with the delay time unit specified for that particular fault.
			100	Retry 4 times	The PMBus device attempts to restart 4 times. If the device fails to restart, it disables the output and remains off until the fault is cleared as described in Section 10.7. The time between the start of each attempt to restart is set by the value in bits [2:] along with the delay time unit specified for that particular fault.
			101	Retry 5 times	The PMBus device attempts to restart 5 times. If the device fails to restart, it disables the output and remains off until the fault is cleared as described in Section 10.7. The time between the start of each attempt to restart is set by the value in bits [2:] along with the delay time unit specified for that particular fault.
			110	Retry 6 times	The PMBus device attempts to restart 6 times. If the device fails to restart, it disables the output and remains off until the fault is cleared as described in Section 10.7. The time between the start of each attempt to restart is set by the value in bits [2:] along with the delay time unit specified for that particular fault.
			111	Retry Continuously	The PMBus device attempts to restart continuously, without limitation, until it is commanded OFF (by the CONTROL pin or OPERATION command or both), bias power is removed, or another fault condition causes the unit to shut down.

2:0	Retry Time and Delay Time	Number of delay time units. Used for either the amount of time the device is to continue operating after a fault is detected or for the amount of time between attempts to restart. The time unit is set in register 0xC8.	0	1	
			1	2	
			2	4	
			3	8	
			4	16	
			5	32	
			6	64	
			7	128	

VIN_OV_WARN_LIMIT (0x57)

Description: Input over voltage warning limit.

Bit	Description	Format	Unit
15:0	Input over voltage warning limit.	Linear	V

VIN_UV_WARN_LIMIT (0x58)

Description: Input under voltage warning limit. This command set also the input voltage threshold for the HRR function (Hybrid Ratio Regulation). The HRR function is enabled with command MFR_SPECIAL_OPTIONS (0xE0).

Bit	Description	Format	Unit
15:0	Input under voltage warning limit and/or HRR threshold.	Linear	V

VIN_UV_FAULT_LIMIT (0x59)

Description: Input under voltage fault limit.

Bit	Description	Format	Unit
15:0	Input under voltage fault limit.	Linear	V

VIN_UV_FAULT_RESPONSE (0x5A)

Description: Input under voltage fault response.

Bit	Function	Description	Value	Function	Description
7:6	Response		00	Ignore Fault	The PMBus device continues operation without interruption.
			01	Perform Retries while Operating	The PMBus device continues operation for the delay time specified by bits [2:0] and the delay time unit specified for that particular fault. If the fault condition is still present at the end of the delay time, the unit responds as programmed in the Retry Setting (bits [5:3]).
			10	Disable and retry	The device shuts down (disables the output) and responds according to the retry setting in bits [5:3].

			11	Disable until Fault Cleared	A fault can be cleared in several ways: The bit is individually cleared, The device receives a CLEAR_FAULTS command, a RESET signal (if one exists) is asserted, the output is commanded through the CTRL pin, the OPERATION command, or the combined action of the CTRL pin and OPERATION command, to turn off and then to turn back on, or Bias power is removed from the PMBus device.
5:3	Retries		000	Do Not Retry	A zero value for the Retry Setting means that the unit does not attempt to restart. The output remains disabled until the fault is cleared (Section 10.7).
			001	Retry Once	The PMBus device attempts to restart 1 time. If the device fails to restart, it disables the output and remains off until the fault is cleared as described in Section 10.7. The time between the start of each attempt to restart is set by the value in bits [2:] along with the delay time unit specified for that particular fault.
			010	Retry Twice	The PMBus device attempts to restart 2 times. If the device fails to restart, it disables the output and remains off until the fault is cleared as described in Section 10.7. The time between the start of each attempt to restart is set by the value in bits [2:] along with the delay time unit specified for that particular fault.
			011	Retry 3 times	The PMBus device attempts to restart 3 times. If the device fails to restart, it disables the output and remains off until the fault is cleared as described in Section 10.7. The time between the start of each attempt to restart is set by the value in bits [2:] along with the delay time unit specified for that particular fault.

			100	Retry 4 times	The PMBus device attempts to restart 4 times. If the device fails to restart, it disables the output and remains off until the fault is cleared as described in Section 10.7. The time between the start of each attempt to restart is set by the value in bits [2:] along with the delay time unit specified for that particular fault.
			101	Retry 5 times	The PMBus device attempts to restart 5 times. If the device fails to restart, it disables the output and remains off until the fault is cleared as described in Section 10.7. The time between the start of each attempt to restart is set by the value in bits [2:] along with the delay time unit specified for that particular fault.
			110	Retry 6 times	The PMBus device attempts to restart 6 times. If the device fails to restart, it disables the output and remains off until the fault is cleared as described in Section 10.7. The time between the start of each attempt to restart is set by the value in bits [2:] along with the delay time unit specified for that particular fault.
			111	Retry Continuously	The PMBus device attempts to restart continuously, without limitation, until it is commanded OFF (by the CONTROL pin or OPERATION command or both), bias power is removed, or another fault condition causes the unit to shut down.
2:0	Retry Time and Delay Time	Number of delay time units. Used for either the amount of time the device is to continue operating after a fault is detected or for the amount of time between attempts to restart. The time unit is set in register 0xC8.	0	1	
			1	2	
			2	4	
			3	8	
			4	16	
			5	32	
			6	64	
			7	128	

POWER_GOOD_ON (0x5E)

Description: Sets the output voltage threshold for asserting PG (Power Good).

Bit	Description	Format	Unit
15:0	The POWER_GOOD_ON command sets the output voltage at which an optional POWER_GOOD signal should be asserted.	Vout Mode Unsigned (Exp = -11)	V

POWER_GOOD_OFF (0x5F)

Description: Sets the output voltage threshold for deasserting PG (Power Good).

Bit	Description	Format	Unit
15:0	The POWER_GOOD_OFF command sets the output voltage at which an optional POWER_GOOD signal should be deasserted.	Vout Mode Unsigned (Exp = -11)	V

TON_DELAY (0x60)

Description: Sets the turn-on delay time

Bit	Description	Format	Unit
15:0	Sets the delay time from ENABLE to start of VOUT rise.	Linear	ms

TON_RISE (0x61)

Description: Sets the turn-on transition time.

Bit	Description	Format	Unit
15:0	Sets the rise time of VOUT after ENABLE and TON_DELAY.	Linear	ms

TON_MAX_FAULT_LIMIT (0x62)

Description: Sets an upper limit, in milliseconds, on how long the unit can attempt to power up the output without reaching the output undervoltage fault limit.

Bit	Description	Format	Unit
15:0	A value of 0 milliseconds means that there is no limit and that the unit can attempt to bring up the output voltage indefinitely.	Linear	ms

TON_MAX_FAULT_RESPONSE (0x63)

Description: Only some of the response types are supported.

Bit	Function	Description	Value	Function	Description
7:6	Response		00	Ignore Fault	The PMBus device continues operation without interruption.
			01	Perform Retries while Operating	The PMBus device continues operation for the delay time specified by bits [2:0] and the delay time unit specified for that particular fault. If the fault condition is still present at the end of the delay time, the unit responds as programmed in the Retry Setting (bits [5:3]).

			10	Disable and retry	The device shuts down (disables the output) and responds according to the retry setting in bits [5:3].
			11	Disable until Fault Cleared	A fault can be cleared in several ways: The bit is individually cleared, The device receives a CLEAR_FAULTS command, a RESET signal (if one exists) is asserted, the output is commanded through the CTRL pin, the OPERATION command, or the combined action of the CTRL pin and OPERATION command, to turn off and then to turn back on, or Bias power is removed from the PMBus device.
5:3	Retries		000	Do Not Retry	A zero value for the Retry Setting means that the unit does not attempt to restart. The output remains disabled until the fault is cleared (Section 10.7).
			001	Retry Once	The PMBus device attempts to restart 1 time. If the device fails to restart, it disables the output and remains off until the fault is cleared as described in Section 10.7. The time between the start of each attempt to restart is set by the value in bits [2:] along with the delay time unit specified for that particular fault.
			010	Retry Twice	The PMBus device attempts to restart 2 times. If the device fails to restart, it disables the output and remains off until the fault is cleared as described in Section 10.7. The time between the start of each attempt to restart is set by the value in bits [2:] along with the delay time unit specified for that particular fault.

			011	Retry 3 times	The PMBus device attempts to restart 3 times. If the device fails to restart, it disables the output and remains off until the fault is cleared as described in Section 10.7. The time between the start of each attempt to restart is set by the value in bits [2:] along with the delay time unit specified for that particular fault.
			100	Retry 4 times	The PMBus device attempts to restart 4 times. If the device fails to restart, it disables the output and remains off until the fault is cleared as described in Section 10.7. The time between the start of each attempt to restart is set by the value in bits [2:] along with the delay time unit specified for that particular fault.
			101	Retry 5 times	The PMBus device attempts to restart 5 times. If the device fails to restart, it disables the output and remains off until the fault is cleared as described in Section 10.7. The time between the start of each attempt to restart is set by the value in bits [2:] along with the delay time unit specified for that particular fault.
			110	Retry 6 times	The PMBus device attempts to restart 6 times. If the device fails to restart, it disables the output and remains off until the fault is cleared as described in Section 10.7. The time between the start of each attempt to restart is set by the value in bits [2:] along with the delay time unit specified for that particular fault.
			111	Retry Continuously	The PMBus device attempts to restart continuously, without limitation, until it is commanded OFF (by the CONTROL pin or OPERATION command or both), bias power is removed, or another fault condition causes the unit to shut down.

2:0	Retry Time and Delay Time	Number of delay time units. Used for either the amount of time the device is to continue operating after a fault is detected or for the amount of time between attempts to restart. The time unit is set in register 0xC8. TON_MAX_FAULT_RESPONSE time unit is referenced to VOUT FAULT time unit.	0	1	
			1	2	
			2	4	
			3	8	
			4	16	
			5	32	
			6	64	
			7	128	

TOFF_DELAY (0x64)

Description: Sets the turn-off delay.

Bit	Description	Format	Unit
15:0	Sets the delay time from DISABLE to start of VOUT fall.	Linear	ms

TOFF_FALL (0x65)

Description: Sets the turn-off transition time.

Bit	Description	Format	Unit
15:0	Sets the fall time for VOUT after DISABLE and TOFF_DELAY.	Linear	ms

TOFF_MAX_WARN_LIMIT (0x66)

Description: Sets an upper limit, in milliseconds, on how long the unit can attempt to power down the output without reaching 12.5% of the output voltage programmed at the time the unit is turned off.

Bit	Description	Format	Unit
15:0		Linear	ms

POUT_OP_WARN_LIMIT (0x6A)

Description: Sets the output over-power warning limit.

Bit	Description	Format	Unit
15:0	Sets the output over-power warning threshold.	Linear	W

PIN_OP_WARN_LIMIT (0x6B)

Description: Sets the input over-power warning limit.

Bit	Description	Format	Unit
15:0	Sets the input over-power warning threshold.	Linear	W

STATUS_BYTE (0x78)

Description: Returns a brief fault/warning status byte.

Bit	Function	Description	Value	Description
6	Off	This bit is asserted if the unit is not providing power to the output, regardless of the reason, including simply not being enabled.	0	No fault
			1	Fault
5	Vout Overvoltage Fault	An output overvoltage fault has occurred.	0	No fault
			1	Fault
4	Iout Overcurrent Fault	An output overcurrent fault has occurred.	0	No fault
			1	Fault
3		An input undervoltage fault has occurred.	0	No fault

	Vin Undervoltage Fault		1	Fault
2	Temperature	A temperature fault or warning has occurred.	0	No fault
			1	Fault
1	Communication/Logic	A communications, memory or logic fault has occurred.	0	No fault
			1	Fault
0	None of the Above	A fault or warning not listed in bits [7:1] has occurred.	0	No fault
			1	Fault

STATUS_WORD (0x79)

Description: Returns an extended fault/warning status byte.

Bit	Function	Description	Value	Description
15	Vout	An output voltage fault or warning has occurred.	0	No fault
			1	Fault
14	Iout/Pout	An output current or output power fault or warning has occurred.	0	No Fault.
			1	Fault.
13	Input	An input voltage, input current, or input power fault or warning has occurred.	0	No Fault.
			1	Fault.
12	Mfr Specific	A manufacturer specific fault or warning has occurred.	0	No fault.
			1	Fault.
11	Power-Good	The Power-Good signal, if present, is negated.	0	No Fault.
			1	Fault.
9	Other	A bit in Status-Other is set.	0	No fault
			1	Fault
6	Off	This bit is asserted if the unit is not providing power to the output, regardless of the reason, including simply not being enabled.	0	No fault
			1	Fault
5	Vout Overvoltage Fault	An output overvoltage fault has occurred.	0	No Fault.
			1	Fault.
4	Iout Overcurrent Fault	An output overcurrent fault has occurred.	0	No Fault.
			1	Fault.
3	Vin Undervoltage Fault	An input undervoltage fault has occurred.	0	No Fault.
			1	Fault.
2	Temperature	A temperature fault or warning has occurred.	0	No Fault.
			1	Fault.
1	Communication/Logic	A communications, memory or logic fault has occurred.	0	No fault.
			1	Fault.
0	None of the Above	A fault or warning not listed in bits [7:1] has occurred.	0	No fault.
			1	Fault.

STATUS_VOUT (0x7A)

Description: Returns Vout-related fault/warning status bits.

Bit	Function	Description	Value	Description
7	Vout Overvoltage Fault	Vout Overvoltage Fault.	0	No Fault.
			1	Fault.
6	Vout Overvoltage Warning	Vout Overvoltage Warning.	0	No Warning.
			1	Warning.
5	Vout Undervoltage Warning	Vout Undervoltage Warning.	0	No Warning.
			1	Warning.
4	Vout Undervoltage Fault	Vout Undervoltage Fault.	0	No Fault.
			1	Fault.
3	Vout Max Warning		0	No Warning.

		Vout Max Warning (An attempt has been made to set the output voltage to value higher than allowed by the Vout Max command (Section 13.5)).	1	Warning.
2	Ton Max Fault	Ton-Max Fault.	0	No Fault
			1	Fault.
1	Toff Max Warning	Toff Max Warning.	0	No Warning.
			1	Warning.

STATUS_IOUT (0x7B)

Description: Returns Iout-related fault/warning status bits.

Bit	Function	Description	Value	Description
7	Iout Overcurrent Fault	Iout Overcurrent Fault.	0	No Fault.
			1	Fault.
6	Iout Overcurrent And Low Voltage Fault	Iout Overcurrent and low voltage fault.	0	No Fault.
			1	Fault.
5	Iout Over Current Warning	Iout Overcurrent Warning.	0	No Warning.
			1	Warning.
4	Iout Undercurrent Fault	Iout Undercurrent Fault.	0	No Fault.
			1	Fault.

STATUS_INPUT (0x7C)

Description: Returns VIN/IIN-related fault/warning status bits.

Bit	Function	Description	Value	Description
7	Vin Overvoltage Fault	Vin Overvoltage Fault.	0	No Fault.
			1	Fault.
6	Vin Overvoltage Warning	VIN Overvoltage Warning.	0	No Warning.
			1	Warning.
5	Vin Undervoltage Warning	Vin Undervoltage Warning.	0	No Warning.
			1	Warning.
4	Vin Undervoltage Fault	Vin Undervoltage Fault.	0	No Fault.
			1	Fault.
3	Insufficient Vin	Asserted when either the input voltage has never exceeded the input turn-on threshold Vin-On, or if the unit did start, the input voltage decreased below the turn-off threshold.	0	No Insufficient VIN encountered yet.
			1	Insufficient Unit is off.

STATUS_TEMPERATURE (0x7D)

Description: Returns the temperature-related fault/warning status bits

Bit	Function	Description	Value	Description
7	Overtemperature Fault	Overtemperature Fault.	0	No Fault.
			1	Fault.
6	Overtemperature Warning	Overtemperature Warning.	0	No Warning.
			1	Warning.
5	Undertemperature Warning	Undertemperature Warning.	0	No Warning.
			1	Warning.
4	Undertemperature Fault	Undertemperature Fault.	0	No Fault.
			1	Fault.

STATUS_CML (0x7E)

Description: Returns Communication/Logic/Memory-related fault/warning status bits.

Bit	Function	Description	Value	Description
7	Invalid Or Unsupported Command Received	Invalid Or Unsupported Command Received.	0	No Invalid Command Received.
			1	Invalid Command Received.
6	Invalid Or Unsupported Data Received	Invalid Or Unsupported Data Received.	0	No Invalid Data Received.
			1	Invalid Data Received.
5	Packet Error Check Failed	Packet Error Check Failed.	0	No Failure.
			1	Failure.
4	Memory Fault Detected	Memory Fault Detected.	0	No Fault.
			1	Fault.
3	Processor Fault Detected	Processor fault detected.	0	No Fault.
			1	Fault.
1	Other Communication Fault	A communication fault other than the ones listed in this table has occurred.	0	No Fault.
			1	Fault.
0	Memory Or Logic Fault	Other Memory Or Logic Fault has occurred.	0	No Fault.
			1	Fault.

STATUS_OTHER (0x7F)

Description: Returns a brief other fault/warning status bits.

Bit	Description	Value	Description
0	The device was the first to assert SMBALERT.		

STATUS_MFR_SPECIFIC (0x80)

Description: Returns manufacturer specific status information.

Bit	Function	Description	Value	Description
7	Sync Fault	Sync fault.	0	No fault.
			1	Fault.
6	Iout Average Overcurrent Fault	Iout average overcurrent fault.	0	No fault.
			1	Fault.
5	Iout Fast Overcurrent Fault	Iout fast overcurrent fault.	0	No fault.
			1	Fault.
4	Short Circuit Protection Fault	Short circuit protection fault.	0	No fault.
			1	Fault.

READ_VIN (0x88)

Description: Returns the measured input voltage.

Bit	Description	Format	Unit
15:0	Returns the input voltage reading.	Linear	V

READ_VOUT (0x8B)

Description: Returns the measured output voltage.

Bit	Description	Format	Unit
15:0	Returns the measured output voltage.	Vout Mode Unsigned (Exp = -11)	V

READ_IOUT (0x8C)

Description: Returns the measured output current.

Bit	Description	Format	Unit
15:0	Returns the measured output current.	Linear	A

READ_TEMPERATURE_1 (0x8D)

Description: Reads temperature from the temperature sensor chosen in MFR_SELECT_TEMPERATURE_SENSOR (0xDC) command.

Bit	Description	Format	Unit
15:0		Linear	°C

READ_DUTY_CYCLE (0x94)

Description: Returns the actual duty cycle in percent.

Bit	Description	Format	Unit
15:0	Returns the actual duty cycle in percent.	Direct	%

READ_FREQUENCY (0x95)

Description: Returns the actual switching frequency.

Bit	Description	Format	Unit
15:0	Returns the actual switching frequency.	Linear	kHz

PMBUS_REVISION (0x98)

Description: Returns the PMBus revision number for this device.

Bit	Function	Description	Value	Function	Description
7:4	Part I Revision	Part I Revision.	0x0	1.0	Part I Revision 1.0.
			0x1	1.1	Part I Revision 1.1.
			0x2	1.2	Part I Revision 1.2.
			0x3	1.3	Part I Revision 1.3.
3:0	Part II Revision	Part II Revision.	0x0	1.0	Part II Revision 1.0.
			0x1	1.1	Part II Revision 1.1.
			0x2	1.2	Part II Revision 1.2.
			0x3	1.3	Part II Revision 1.3.

MFR_ID (0x99)

Description: Sets the Manufacturers ID

Bit	Description	Format
95:0	Maximum of 12 characters.	ASCII

MFR_MODEL (0x9A)

Description: Sets the MFR MODEL string.

Bit	Description	Format
159:0	Maximum of 20 characters.	ASCII

MFR_REVISION (0x9B)

Description: Sets the MFR revision string.

Bit	Description	Format
95:0	Maximum of 12 characters.	ASCII

MFR_LOCATION (0x9C)

Description: Sets the MFR location string.

Bit	Description	Format
95:0	Maximum of 12 characters.	ASCII

MFR_DATE (0x9D)

Description: This command returns the date the regulator was manufactured.

Bit	Description	Format
95:0	Maximum of 12 characters.	ASCII

MFR_SERIAL (0x9E)

Description: This command returns a string of 13 characters and numbers that provides a unique identification of the regulator.

Bit	Description	Format
159:0	Maximum of 20 characters.	ASCII

USER_DATA_00 (0xB0)

Description: This command is available as generic read/write storage for customers.

Bit	Description	Format
127:0	16 bytes of user data.	Byte Array

FW_CONFIG_FAULTS (0xC8)

Description: FW CONFIG FAULTS parameter

Bit	Function	Description	Value	Function	Description
7:6	Vout Delay Unit	Vout_Delay_Unit Time unit for retry responses. 0: 1ms, 1: 4ms, 2: 16ms, 3: 256ms	00	1ms/unit	Vout Delay Unit Time unit for retry responses
			01	4ms/unit	Vout Delay Unit Time unit for retry responses
			10	16ms/unit	Vout Delay Unit Time unit for retry responses
			11	256ms/unit	Vout Delay Unit Time unit for retry responses
5:4	Vin Delay Unit	Vin_Delay_Unit Time unit for retry responses. 0: 1ms, 1: 4ms, 2: 16ms, 3: 256ms	00	1ms/unit	Vin Delay Unit Time unit for retry responses
			01	4ms/unit	Vin Delay Unit Time unit for retry responses
			10	16ms/unit	Vin Delay Unit Time unit for retry responses
			11	256ms/unit	Vin Delay Unit Time unit for retry responses
3:2	IOUT Delay Unit	IOUT_Delay_Unit Time unit for retry responses. 0: 1ms, 1: 4ms, 2: 16ms, 3: 256ms	00	1ms/unit	IOUT Delay Unit Time unit for retry responses
			01	4ms/unit	IOUT Delay Unit Time unit for retry responses
			10	16ms/unit	IOUT Delay Unit Time unit for retry responses
			11	256ms/unit	IOUT Delay Unit Time unit for retry responses

1:0	Temperature Delay Unit	Temperature_Delay_Unit Time unit for retry responses. 0: 1ms, 1: 4ms, 2: 16ms, 3: 256ms	00	1ms/unit	Temperature Delay Unit Time unit for retry responses
			01	4ms/unit	Temperature Delay Unit Time unit for retry responses
			10	16ms/unit	Temperature Delay Unit Time unit for retry responses
			11	256ms/unit	Temperature Delay Unit Time unit for retry responses

FW_CONFIG_PMBUS (0xC9)

Description: The GPIO selection for the fault select, Power good select, and enable select has to be unique, please choose different values for these configurations. The overall I2C address (Base + offset or XADDR1/XADDR2) and PMBus (Base + offset or XADDR1/XADDR2) can not be same, please configure different address either base or offset.

Bit	Function	Description	Format
31:24	PMBus Base Addr	Base Address for PMBus offset to start from	Integer Unsigned
23:17	PMBus Addr Offset	PMBUS Address offset when resistor offset Not enabled	Integer Unsigned

Bit	Function	Description	Value	Function	Description
39	Power good polarity	Power good polarity (1:active high; 0: active low).	0	Active low	
			1	Active high	
32	Control pin polarity	Control pin polarity (1:active high; 0: active low).	0	Active low	
			1	Active high	
16	PMBus Addr Offset Resistor Enable	PMBus_addr_offset_enable Enable PMBUS Address Offset via resistor	0	Disabled	
			1	Enabled	

MFR_IOUT_OC_FAST_FAULT_RESPONSE (0xCA)

Description: Output over current fault response.

Bit	Function	Description	Value	Function	Description
7:6	Response	For all values of bits [7:6],the device: Sets the corresponding fault bit in the status registers and If the device supports notifying the host, it does so.	00	Ignore Fault	The PMBus device continues to operate indefinitely while maintaining the output current at the value set by IOUT_OC_FAULT_LIMIT without regard to the output voltage (known as constant-current or brickwall limiting).

			11	Shutdown and Retry	The PMBus device continues to operate, maintaining the output current at the value set by IOUT_OC_FAST_FAULT_LIMIT without regard to the output voltage, for the delay time set by bits [2:0] and the delay time units for specified in the IOUT_OC_FAST_FAULT_RESPONSE. If the device is still operating in current limiting at the end of the delay time, the device responds as programmed by the Retry Setting in bits [5:3].
5:3	Retries	The device attempts to restart the number of times set by these bits. 000b means the device does not attempt a restart. 111b means the device attempts restarting continuously.	000	Do Not Retry	A zero value for the Retry Setting means that the unit does not attempt to restart. The output remains disabled until the fault is cleared (Section 10.7).
			001	Retry Once	The PMBus device attempts to restart 1 time. If the device fails to restart, it disables the output and remains off until the fault is cleared as described in Section 10.7. The time between the start of each attempt to restart is set by the value in bits [2:] along with the delay time unit specified for that particular fault.
			010	Retry Twice	The PMBus device attempts to restart 2 times. If the device fails to restart, it disables the output and remains off until the fault is cleared as described in Section 10.7. The time between the start of each attempt to restart is set by the value in bits [2:] along with the delay time unit specified for that particular fault.

			011	Retry 3 times	The PMBus device attempts to restart 3 times. If the device fails to restart, it disables the output and remains off until the fault is cleared as described in Section 10.7. The time between the start of each attempt to restart is set by the value in bits [2:] along with the delay time unit specified for that particular fault.
			100	Retry 4 times	The PMBus device attempts to restart 4 times. If the device fails to restart, it disables the output and remains off until the fault is cleared as described in Section 10.7. The time between the start of each attempt to restart is set by the value in bits [2:] along with the delay time unit specified for that particular fault.
			101	Retry 5 times	The PMBus device attempts to restart 5 times. If the device fails to restart, it disables the output and remains off until the fault is cleared as described in Section 10.7. The time between the start of each attempt to restart is set by the value in bits [2:] along with the delay time unit specified for that particular fault.
			110	Retry 6 times	The PMBus device attempts to restart 6 times. If the device fails to restart, it disables the output and remains off until the fault is cleared as described in Section 10.7. The time between the start of each attempt to restart is set by the value in bits [2:] along with the delay time unit specified for that particular fault.
			111	Retry Continuously	The PMBus device attempts to restart continuously, without limitation, until it is commanded OFF (by the CONTROL pin or OPERATION command or both), bias power is removed, or another fault condition causes the unit to shut down.

2:0	Retry Time and Delay Time	Number of delay time units. Used for either the amount of time the device is to continue operating after a fault is detected or for the amount of time between attempts to restart. The time unit is set in register 0xC8.	0	1	
			1	2	
			2	4	
			3	8	
			4	16	
			5	32	
			6	64	
			7	128	

MFR_IOUT_AVG_OC_FAULT_LIMIT (0xD0)

Description: Average output over current limit.

Bit	Description	Format	Unit
15:0	Average output over current fault limit.	Linear	A

MFR_IOUT_OC_FAST_FAULT_LIMIT (0xD1)

Description: The MFR_IOUT_OC_FAST_FAULT_LIMIT command sets or retrieves lout fast overcurrent fault threshold, in Amperes.

Bit	Description	Format	Unit
15:0	Sets lout fast over-current fault threshold.	Integer Unsigned	A

MFR_IOUT_AVG_COEFF (0xD2)

Description: Coefficient for controlling the averaging strength for the averaged lout current limit.

Bit	Description	Format
5:0	Coefficient for controlling the averaging strength for the averaged lout current limit. Value 0-63. Setting the coefficient to 0 will disable the averaging and the average current limit behaviour.	Integer Unsigned

MFR_READ_EVENT (0xD7)

Description: Retrieves historical information from the snapshot function stored in OTP memory. The MFR_EVENT_INDEX command is used to retrieve the number of available snapshots and to set which snapshot should be available to read through this command.

Bit	Function	Description	Format	Unit
207:176	Ticks Low Bytes	The Lowest bytes of the event ticks.	Fixed Point Unsigned	
175:168	Ticks High Byte	The highest byte of the event ticks.	Byte Array	
95:80	Read Duty Cycle	Returns the actual duty cycle in percent.	Integer Unsigned	%
79:64	Read Temperature 1		Integer Signed	°C
63:48	Read lout	Returns the measured output current.	Fixed Point Signed	A
47:32	Read Vout	Returns the measured output voltage.	Fixed Point Signed	V

31:16	Read Vin	Returns the input voltage reading.	Fixed Point Signed	V
15:0	Event ID	Event id < 2 ¹⁶ .	Integer Unsigned	

Bit	Function	Description	Value	Function	Description
167:164	Old State	The old state bit field contains the state of the module around 4ms before the error occurred. This is generally of higher interest than the error state.	0000	Idle	Idle.
			0001	Ton Delay	Ton Delay.
			0010	Ramp Up	Ramp Up.
			0011	Regulating	Regulating.
			0100	Toff Delay	Toff Delay.
			0101	Ramp Down	Ramp Down.
			0110	Fault	Fault.
163:160	Error State	The error state bit field contains the state of the module when the error is detected, this will normally have the value FAULT unless a firmware fault occurs or the response setting is set to ignore fault.	0000	Idle	Idle.
			0001	Ton Delay	Ton Delay.
			0010	Ramp Up	Ramp Up.
			0011	Regulating	Regulating.
			0100	Toff Delay	Toff Delay.
			0101	Ramp Down	Ramp Down.
			0110	Fault	Fault.
159	Sync Fault	Sync fault.	0		No fault.
			1		Fault.
158	Iout Average Overcurrent Fault	Iout average overcurrent fault.	0		No fault.
			1		Fault.
157	Iout Fast Overcurrent Fault	Iout fast overcurrent fault.	0		No fault.
			1		Fault.
156	Short Circuit Protection Fault	Short circuit protection fault.	0		No fault.
			1		Fault.
151	Invalid Or Unsupported Command Received	Invalid Or Unsupported Command Received.	0		No Invalid Command Received.
			1		Invalid Command Received.
150	Invalid Or Unsupported Data Received	Invalid Or Unsupported Data Received.	0		No Invalid Data Received.
			1		Invalid Data Received.
149	Packet Error Check Failed	Packet Error Check Failed.	0		No Failure.
			1		Failure.
148	Memory Fault Detected	Memory Fault Detected.	0		No Fault.
			1		Fault.
145	Other Communication Fault	A communication fault other than the ones listed in this table has occurred.	0		No Fault.
			1		Fault.
144	Memory Or Logic Fault	Other Memory Or Logic Fault has occurred.	0		No Fault.
			1		Fault.
143	Overtemperature Fault	Overtemperature Fault.	0		No Fault.
			1		Fault.
142	Overtemperature Warning	Overtemperature Warning.	0		No Warning.
			1		Warning.
141		Undertemperature Warning.	0		No Warning.

	Undertemperature Warning		1		Warning.
140	Undertemperature Fault	Undertemperature Fault.	0		No Fault.
			1		Fault.
135	Vin Overvoltage Fault	Vin Overvoltage Fault.	0		No Fault.
			1		Fault.
134	Vin Overvoltage Warning	VIN Overvoltage Warning.	0		No Warning.
			1		Warning.
133	Vin Undervoltage Warning	Vin Undervoltage Warning.	0		No Warning.
			1		Warning.
132	Vin Undervoltage Fault	Vin Undervoltage Fault.	0		No Fault.
			1		Fault.
131	Insufficient Vin	Asserted when either the input voltage has never exceeded the input turn-on threshold Vin-On, or if the unit did start, the input voltage decreased below the turn-off threshold.	0		No Insufficient VIN encountered yet.
			1		Insufficient Unit is off.
127	Iout Overcurrent Fault	Iout Overcurrent Fault.	0		No Fault.
			1		Fault.
126	Iout Overcurrent And Low Voltage Fault	Iout Overcurrent and low voltage fault.	0		No Fault.
			1		Fault.
125	Iout Overcurrent Warning	Iout Overcurrent Warning.	0		No Warning.
			1		Warning.
124	Iout Undercurrent Fault	Iout Undercurrent Fault.	0		No Fault.
			1		Fault.
119	Vout Overvoltage Fault	Vout Overvoltage Fault.	0		No Fault.
			1		Fault.
118	Vout Overvoltage Warning	Vout Overvoltage Warning.	0		No Warning.
			1		Warning.
117	Vout Undervoltage Warning	Vout Undervoltage Warning.	0		No Warning.
			1		Warning.
116	Vout Undervoltage Fault	Vout Undervoltage Fault.	0		No Fault.
			1		Fault.
115	Vout Max Warning	Vout Max Warning (An attempt has been made to set the output voltage to value higher than allowed by the Vout Max command (Section 13.5)).	0		No Warning.
			1		Warning.
114	Ton Max Fault	Ton-Max Fault.	0		No Fault
			1		Fault.
113		Toff Max Warning.	0		No Warning.

	Toff Max Warning		1		Warning.
111	Vout	An output voltage fault or warning has occurred.	0		No fault
			1		Fault
110	Iout/Pout	An output current or output power fault or warning has occurred.	0		No Fault.
			1		Fault.
109	Input	An input voltage, input current, or input power fault or warning has occurred.	0		No Fault.
			1		Fault.
108	Mfr Specific	A manufacturer specific fault or warning has occurred.	0		No Fault.
			1		Fault.
107	Power-Good	The Power-Good signal, if present, is negated.	0		No Fault.
			1		Fault.
102	Off	This bit is asserted if the unit is not providing power to the output, regardless of the reason, including simply not being enabled.	0		No fault
			1		Fault
101	Vout Overvoltage Fault	An output overvoltage fault has occurred.	0		No Fault.
			1		Fault.
100	Iout Overcurrent Fault	An output overcurrent fault has occurred.	0		No Fault.
			1		Fault.
99	Vin Undervoltage Fault	An input undervoltage fault has occurred.	0		No Fault.
			1		Fault.
98	Temperature	A temperature fault or warning has occurred.	0		No Fault.
			1		Fault.
97	Communication/Logic	A communications, memory or logic fault has occurred.	0		No fault.
			1		Fault.
96	None of the Above	A fault or warning not listed in bits [7:1] has occurred.	0		No fault.
			1		Fault.

MFR_ISHARE_THRESHOLD (0xDA)

Description: MFR_ISHARE_THRESHOLD defines a current sharing deadzone.

Bit	Description	Format	Unit
15:0	MFR_ISHARE_THRESHOLD defines a current sharing deadzone, which is share adjustment is zero out. This means that the current sharing error must be greater than the value specified in MFR_ISHARE_THRESHOLD. By setting this command to 0x0000, the active current share is disabled.	Linear	A

MFR_EVENT_INDEX (0xDB)

Description: When reading this command returns the number of events logged. When writing to this command it controls which event can be retrieved via the MFR_READ_EVENT command. Valid values when writing are the integers in the interval [0; count - 1].

Bit	Description	Format
15:0	Mfr. event index.	Integer Unsigned

MFR_SELECT_TEMPERATURE_SENSOR (0xDC)

Description: Select which temperature sensor, internal one or external remote temperature sensor, is used.

Bit	Function	Description	Value	Function	Description
4:3	Fault Source Select	Select which temperature sensor, internal one or external remote temperature sensor, is used.	00	Temp A	Temp A temperature sensor selected.
			01	Temp B	Temp B temperature sensor selected.
			10	Temp I	Temp I temperature sensor selected.
2:0	READ_TEMPERATURE_1 READ_TEMPERATURE_2 Source Select	READ_TEMPERATURE_1 READ_TEMPERATURE_2 Source Select.	000	TempA TempB	TempA (External Temperature sensor A) TempB (External Temperature sensor B).
			001	TempA TempI	TempA (External Temperature sensor A) TempI (Internal Temperature sensor).
			010	TempB TempA	TempB (External Temperature sensor B) TempA (External Temperature sensor A).
			011	TempB TempI	TempB (External Temperature sensor B) TempI (Internal Temperature sensor).
			100	TempI TempA	TempI (Internal Temperature sensor) TempA (External Temperature sensor A).
			101	TempI TempB	TempI (Internal Temperature sensor) TempB (External Temperature sensor B).

MFR_FLEX_FIRMWARE_CMD (0xE0)

Description: Mfr. firmware command.

Bit	Description	Format
63:0	Mfr. firmware command.	Byte Array

MFR_FILTER_COEFF (0xE8)

Description: Mfr. pid coefficients

Bit	Function	Description	Format
30:24	PID KD	PID derivative coefficient	Integer Unsigned
23:18	PID KI	PID integral coefficient	Integer Unsigned
17:12	PID KP	PID proportional coefficient	Integer Unsigned
11:6	PID pre-filter 2	PID pre-filter 2 coefficient	Integer Unsigned
5:0	PID pre-filter 1	Pid pre-filter 1 coefficient	Integer Unsigned

MFR_IOUT_APC (0xEA)

Description: The iout apc gain.

Bit	Description	Format	Unit
15:0	SSet the iout apc gain. the format is Linear 11, Exponent is -9 or -8 (User selection possible). The LSB varies with isen_gain_mode - ISEN_LSB/Secondary current sense resistor (Rsense).	Linear	A

MFR_MULTI_PIN_CONFIG (0xF9)

Description: The MFR_MULTI_PIN_CONFIG command can be re-configured to enable or disable different functions and set the pin configuration.

Bit	Function	Description	Value	Function	Description
-----	----------	-------------	-------	----------	-------------

9	Enable Snapshot Feature	Enables the snapshot feature. When enabled the snapshot function will run once every ms to collect telemetry data and regulator state into ring buffers and to check for OVF, OCF or OTF events.	0		Disabled
			1		Enabled
2	Power Good Pull-down	This bit enables or disables Power Good pin pull-down.	0	Disabled	
			1	Enabled	
1	Power Good Output	Two output options are available for Power Good output, they are Push/Pull or Open Drain.	0	Push/Pull	Power Good configured Push/Pull.
			1	Open Drain	Power Good configured Open Drain.

MFR_ADDED_DROOP_DURING_RAMP (0xFC)

Description: Set an added droop during ramp.

Bit	Description	Format	Unit
15:0	Sets an added effective load line (V/I slope) for the rail in which the device is used, during ramp up.	Linear	mV/ A