

## BMR323

### 8:1 fixed ratio digital IBC (600 W)



BMR323 is a compact, unregulated and non-isolated intermediate bus converter (IBC). It is intended for applications in need of a low voltage IBC for improved system efficiencies. Typical use areas are AI and Cloud Computing applications.

BMR323 delivers a peak efficiency of 97.8% at half load. It offers a PMBus compatible digital interface, and is supported by the Flex Power Designer tool.

Up to 6 units can be used in parallel to supply an overall output power of up to 3600 W.



### Key features

- 8:1 fixed ratio IBC
- Small form factor
- Parallelable - up to 6 units
- Unregulated
- Non-isolated
- Peak efficiency 97.8%
- Digital interface with PMBus
- Meets safety requirements per IEC/EN/UL 62368-1

### Soldering methods

- Pb Free SMD reflow

### Key electrical information

Parameter	Values
Input range	40 - 60 V
Output voltage	5 - 7.5 V
Continuous output current	90 A at 54 V <sub>in</sub>
Continuous output power	600 W
Peak power	1200 W

### Mechanical

27.0 x 18.0 x 6.7 mm / 1.06 x 0.71 x 0.26 in

### Application areas

- Designed for Artificial Intelligence (AI) applications

## Product options

The table below describes the different product options.

Example:	BMR323	1	0	00	/001	C	Definitions
<b>Product family</b>	BMR323						
<b>Pin length options</b>		1					1 = SMD
<b>Baseplate / HS option</b>			0				0 = No baseplate
<b>Other hardware options</b>				00			00 = Standard variant
<b>Configuration code</b>					/001		/001 = PMBus base address 0x6n <i>Note, see resistor table in PMBus addressing section of the Design &amp; Application Guidelines.</i>
<b>Packaging options</b>						C	C = Tape on Reel

For more information, please refer to Part 3 [Mechanical information](#).

If you do not find the variant you are looking for, please contact us at [Flex Power Modules](#).

## Order number examples

Part number	V <sub>in</sub>	Output	Configuration
<b>BMR3231000/001C</b>	40-60 V	5-7.5 V / 90 A / 600 W	No base plate / standard variant / antistatic tape and reel package

## Part 1: Electrical specifications

### Absolute maximum ratings

Stress in excess of our defined *absolute maximum ratings* may cause permanent damage to the converter. Absolute maximum ratings, also referred to as *non-destructive limits*, are normally tested with one parameter at a time exceeding the limits in the electrical specification.

Characteristics	min	max	unit
Operating temperature ( $T_{P1}$ )	-40	125	°C
Storage temperature	-55	125	°C
Input voltage ( $V_{in}$ )	-0.3	64	V
5V $V_{CC}$	-0.3	5.5	V
EN, PG, ALERT, ADDR, SCL, SDA	-0.3	3.6	V

### Reliability

Failure rate ( $\lambda$ ) and mean time between failures ( $MTBF = 1 / \lambda$ ) are calculated based on *Telcordia SR-332 Issue 4: Method 1, Case 3, (80% of  $I_{out\_TDP}$ ,  $T_{P1} = 40^\circ\text{C}$ , Airflow = 200 LFM)*.

### Typical application diagram

	Mean	90% confidence level	Unit
Steady-state failure rate ( $\lambda$ )	134	163	nfailures/h
Standard deviation ( $\sigma$ )	22.6		nfailures/h
MTBF	7.49	6.15	MHr

Capacitor values are defined in the Electrical Specification tables. The EMI filter is defined in the EMC Part 2.

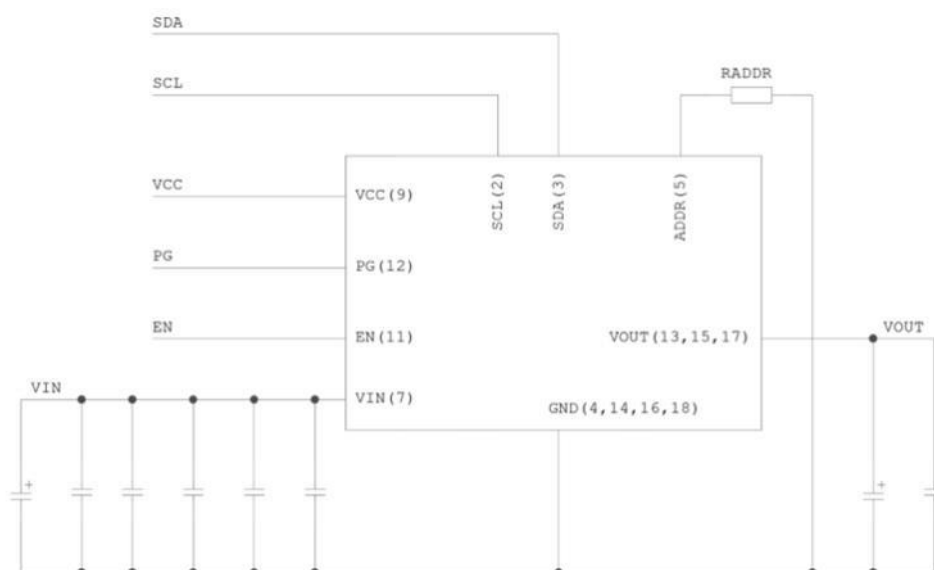

## Part 1: Electrical specifications

**Electrical specifications for BMR3231000/001****6.75 V, 90 A (175A peak) / 600 W (1200 W peak)**

Min and Max values are valid for:  $T_{P1} = -30$  to  $+95^{\circ}\text{C}$ ,  $V_{in} = 40$  to  $60$  V, unless otherwise specified under conditions. Typical values given at:  $T_{P1} = +25^{\circ}\text{C}$ ,  $V_{in} = 54$  V, max  $P_{out\_TDP}$ , unless otherwise specified under conditions, see Note 1.

Additional external  $C_{in} = 470$   $\mu\text{F}$ ,  $C_{out} = 2 \times 470$   $\mu\text{F}$

Characteristic	conditions	minimum	typical	maximum	unit
<b>Key features</b>					
Efficiency ( $\eta$ )	50% of $P_{out\_TDP}$		97.8		%
	100% of $P_{out\_TDP}$		97.0		%
	50% of $P_{out\_TDP}$ $V_{in} = 40\text{V}$		97.2		%
	100% of $P_{out\_TDP}$ $V_{in} = 40\text{V}$		96.1		%
$P_{out\_TDP}$ thermal design power (TDP)	See Note 1			600	W
$P_{out\_MAX}$ peak power	See Note 1			1200	W
Power dissipation	100 % of $P_{out\_TDP}$		18.7		W
Switching frequency ( $f_s$ )	0-100 % of $P_{out\_TDP}$		600		kHz
Recommended capacitive load				5000	$\mu\text{F}$
<b>Input characteristics</b>					
Input voltage range ( $V_{in}$ )		40	54	60	V
Input idling power	$P_{out} = 0$ W		3.3		W
Input standby power	(turned off with EN)		91		mW
Input OVP			64		V
Internal input capacitance			28.2		$\mu\text{F}$
Recommended external input capacitance	See Note 2		470		$\mu\text{F}$

Note 1: Max. output current is rated at 200A at 40Vin. Max power is  $\leq 1000\text{W}$  and continuous power (thermal design power TDP) is  $\leq 600\text{W}$  depending on thermal conditions.

Note 2: Typical value (recommended) is  $470$   $\mu\text{F} + 5 \times 2.2$   $\mu\text{F}$

## Part 1: Electrical specifications

**Electrical specifications for BMR3231000/001****6.75 V, 90 A (175A peak) / 600 W (1200 W peak)**

Min and Max values are valid for:  $T_{P1} = -30$  to  $+95^{\circ}\text{C}$ ,  $V_{in} = 40$  to  $60$  V, unless otherwise specified under conditions. Typical values given at:  $T_{P1} = +25^{\circ}\text{C}$ ,  $V_{in} = 54$  V, max  $P_{out\_TDP}$ , unless otherwise specified under conditions, see Note 1.

Additional external  $C_{in} = 470$   $\mu\text{F}$ ,  $C_{out} = 2 \times 470$   $\mu\text{F}$

Characteristic	conditions	minimum	typical	maximum	unit
<b>Output characteristics</b>					
Output voltage	$P_{out} = 0$ W	5.00	6.75	7.50	V
Output voltage	Disabled, no load		3		mV
Output current ( $I_{out}$ )	$V_{in} = 40$ - $60$ V, PG asserted	0	90	135	A
Max start-up load	Before PG			0	A
Output voltage droop	$I_{out}$ step from 0 to 90 A		200		mV
Output ripple & noise	20 MHz BW, see Note 1		22		mV <sub>p-p</sub>
Internal output capacitance	$V_{out} = 0$ V		250		$\mu\text{F}$
<b>On/off control</b>					
Turn-off input voltage	Decreasing input voltage		35		V
Turn-on input voltage	Increasing input voltage		37		V
On Delay Time	From EN asserted to ramp start		1.7		ms
Ramp-up time	From 10% to 90% of $V_{out}$ , $I_{out} = 0$ A		2.8		ms
Start-up time	From $V_{in} > VIN\_ON$ to PG		16		ms
Enable start-up time	FROM EN to PG		15		ms
Logic high: trigger level	EN pin, Voltage Rising	2.1			V
Logic low: trigger level	EN pin, Voltage Falling			1.9	V
Sink current	EN pin		10		mA

Note 1: See Technical Reference: Application and design considerations.

## Part 1: Electrical specifications

**Electrical specifications for BMR3231000/001****6.75 V, 90 A (175A peak) / 600 W (1200 W peak)**

Characteristic	conditions	minimum	typical	maximum	unit
<b>Protection features</b>					
Input Over Voltage fault limit (IOVP)	Latch		64		V
Output undervoltage fault limit (UVP)	Latch		2		V
Output overvoltage fault limit (OVP)	Latch		8.25		V
Over temperature fault limit (OTP)	Latch		125		°C
Over temperature warning limit (OTW)			90		°C
Over Current Protection (OCP)	Fast applicable on pulses, shorter than 5 ms.	200	230	250	A
	Average, Note 1	150	155	200	A
Response times	IUVP, IOVP, UVP, OVP, OTP		2		µs
	Fast OCP, 77-160 A		17		ms
	Average OCP, 77A-140 A		170		ms
<b>5.0 V Vcc Auxiliary power</b>					
Voltage		4.5	5.0	5.5	V
Current			250	360	mA

Note 1: See Technical Reference: Application and design considerations. The threshold is compared against a moving average value of four samples with 0.25 ms sampling interval. In addition, up to 0.3 ms may pass after a fault is triggered before switching stops.

## Part 1: Electrical specifications

**Electrical specifications for BMR3231000/001****6.75 V, 90 A (175A peak) / 600 W (1200 W peak)**

Characteristic	conditions	minimum	typical	maximum	unit
<b>Monitoring &amp; Control</b>					
UVLO <sub>VIN</sub> - Under Voltage Lock-Out	V <sub>in</sub> ON	36.1	36.8	37.5	V
	V <sub>in</sub> OFF	33.5	34.2	34.9	V
Power Good Delay Time	From V <sub>out</sub> = 100 % to PG asserted		6.5		ms
Power Good Threshold	Low to high transition		4.8		V
	High to low transition, <i>Note 1</i>		4.5		V
V <sub>IL</sub> - Logic input low	SCL, SDA			1.0	V
V <sub>IL</sub> - Logic input high	SCL, SDA	2.3			V
V <sub>OL</sub> - Logic output low	SDA, PG			400	mV
I <sub>OL</sub> - Logic output low sink current	SDA, PG			20	mA
I <sub>LEAK</sub> - Logic leakage current	SDA, SCL, PG	-5		5	µA
C <sub>L_PIN</sub> - Logic input capacitance	SDA, SCL, EN		7		pF
f <sub>SMB</sub> - SMBus Operating frequency		100		400	kHz
EN - Enable	See page 5 "On/Off control"				

In the table below all PMBus commands are written in capital letters.

T<sub>P1</sub> = -20 to + 95 °C, V<sub>in</sub> = 40 to 60 V, unless otherwise specified under conditions.

Typical values given at: T<sub>P1</sub> = +25 °C, V<sub>in</sub> = 54 V, max P<sub>out\_TDP</sub>, unless otherwise specified under conditions

For more detailed information please refer to Technical Reference Document: PMBus commands. This product is supported by the [Flex Power Designer tool](#).

Command	Conditions	minimum	typical	maximum	unit
<b>Monitoring accuracy</b>					
Input voltage READ_VIN			±1		%
Output voltage READ_VOUT			±1		%
Output current READ_IOUT	V <sub>in</sub> = 54 V, I <sub>out</sub> = 90 A		±5		%
Temperature READ_TEMPERATURE_1	T ≥ 25 °C		±1		°C

*Note 1: Power Good is deasserted when the output voltage is disabled, regardless of the output voltage level.*



## Part 2: EMC

### EMC specifications

Conducted EMI measured according to EN55022 / EN55032, CISPR 22 / CISPR 32 and FCC part 15J (see test set-up below). The fundamental switching frequency is 600 kHz for BMR323. The EMI characteristics below is measured at  $V_{in} = 54V$  and  $max I_{out}$ .

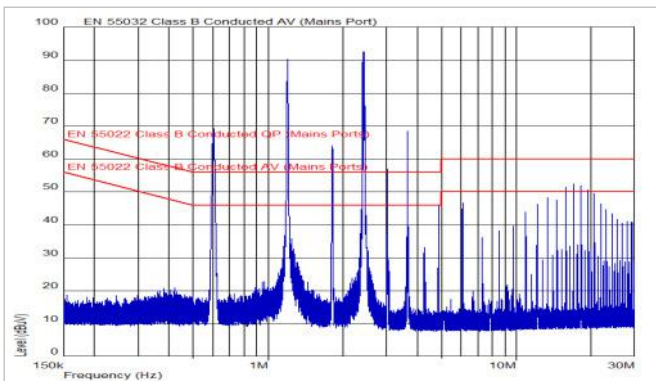

Figure 8: EMI without filter. (Blue graph = QP values)

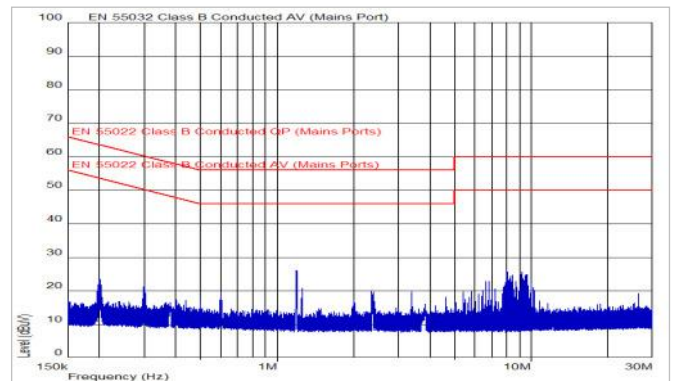

Figure 9: EMI with an optional external filter, EN55032. Test method and limits are the same as EN55022. (Blue graph = QP values)

### Optional external filter for Class B

Suggested external input filter in order to meet Class B in EN 55022 / EN 55032, CISPR 22 / CISPR 32 and FCC part 15J.

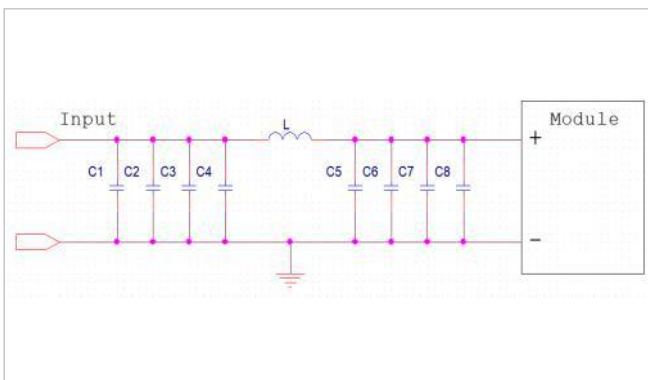

Figure 10: Filter components:

C1-C3, C6-C8 2.2uF 10% 1206 100V X7R, capacitor  
C4-C5 10uF 100VDC X7R 10%, capacitor  
L1 2.2uH 20% 26A DC, Inductor

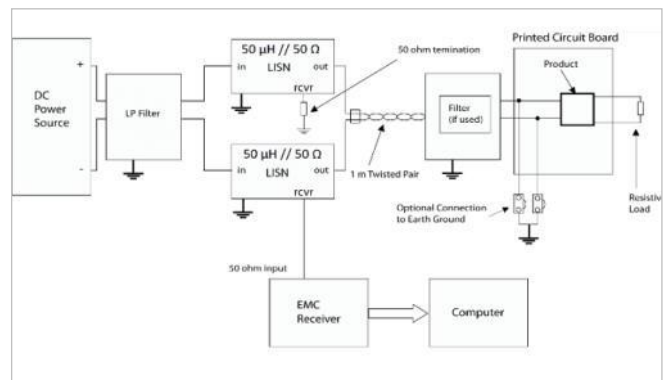
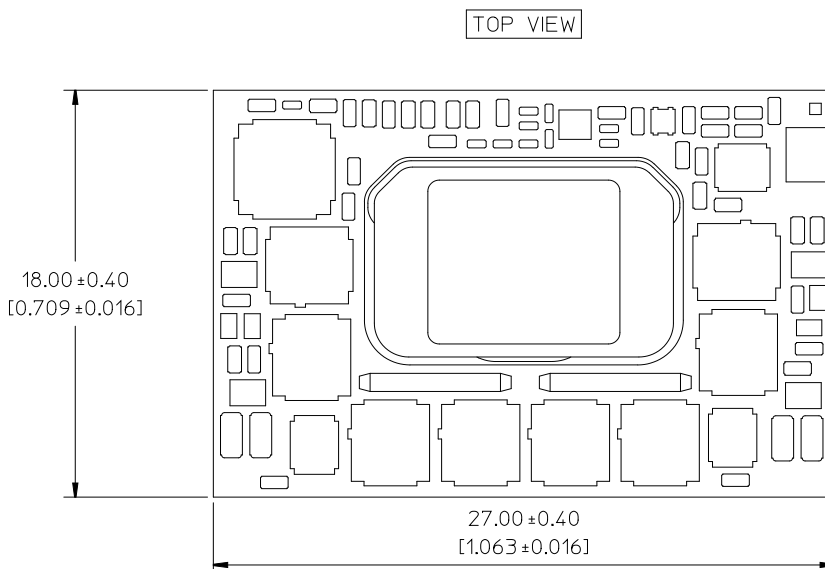
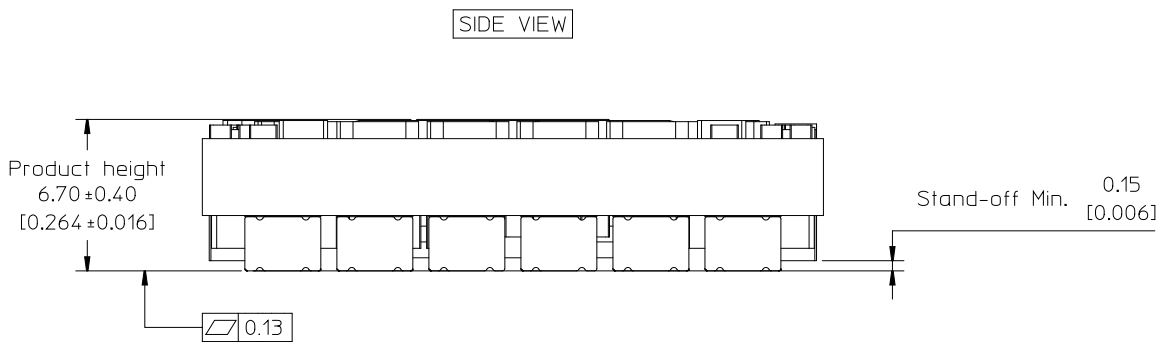
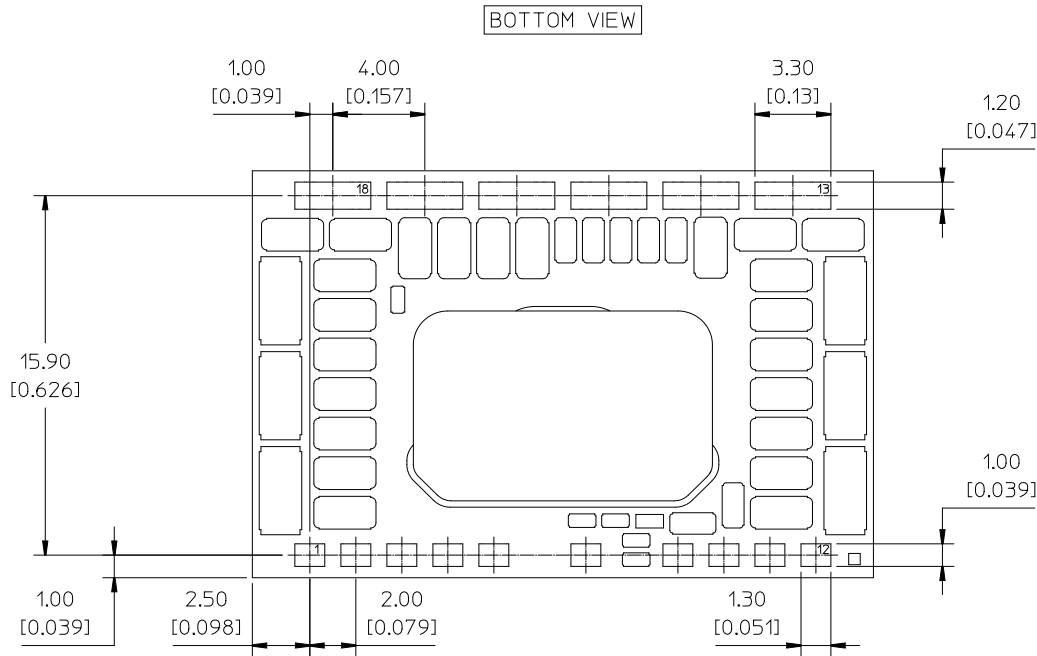

Figure 11: Test set-up

### Layout recommendations

The radiated EMI performance of the product will depend on the PCB layout and ground layer design. It is also important to consider the stand-off of the product. If a ground layer is used, it should be connected to the output of the product and the equipment ground or chassis. A ground layer will increase the stray capacitance in the PCB and improve the high frequency EMC performance.

**Part 3: Mechanical information**  
**BMR323 1000/xxx: surface mounted**



NOTES:

WEIGHT  
Typical: 10.6 g

All dimensions in mm and [inch].  
Tolerances unless specified:  
x.x mm ±0.50 mm, [x.xxx in. ±0.02 in.]  
x.xx mm ±0.25 mm, [x.xxx in. ±0.010 in.]  
(Not applied on footprint and typical values)

3D MODELS  
3D .stp models are available on request.

All component placements, whether shown as physical components or symbolical outline, are for reference only and are subject to change throughout the product's life cycle unless explicitly described and dimensioned in this drawing.

Part 3: Mechanical information

TOP VIEW - Pin-out description and pin positions

RECOMMENDED PAD LAYOUT AND FOOTPRINT. TOP VIEW, THROUGH THE PRODUCT

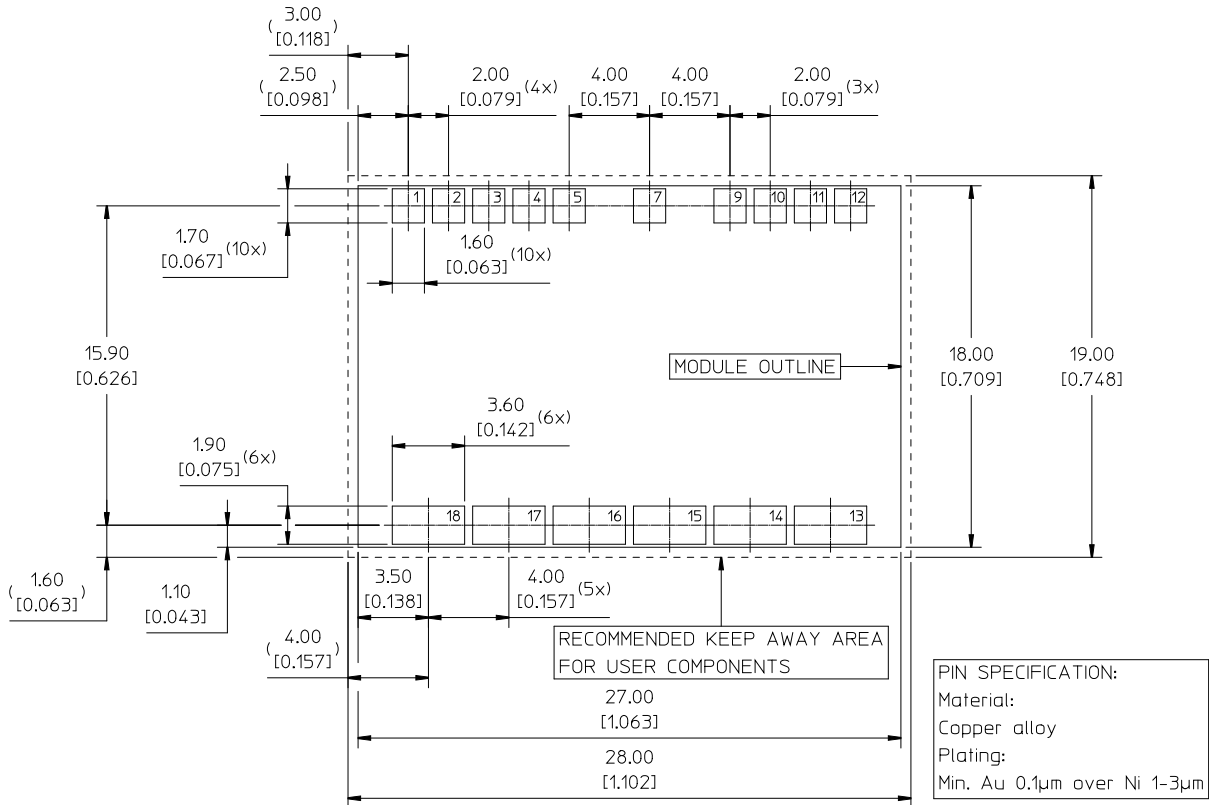

Pin	Designation	Type	Function
1	NC		
2	SCL	Input/Output	PMBus clock
3	SDA	Input/Output	PMBus data
4	GND	Power	Power ground
5	ADDR	Input	PMBus address pin strap
6	Not mounted		
7	VIN	Power	Input voltage
8	Not mounted		
9	VCC	Power	Auxiliary supply
10	NC		
11	EN	Input	Enable, active high
12	PG	Open Drain	Power good, active high
13, 15, 17	VOUT	Power	Output voltage
14, 16, 18	GND	Power	Power ground

## Part 4: Thermal considerations

### Thermal considerations

#### General

The product is designed with power switches on top to operate with top side cooling towards a heat sink or a cold plate. This is required to handle operation with high load. Cooling is also achieved by conduction to the host board and surrounding air. Sufficient cooling must be provided to ensure reliable operation. The Output Current Derating graph found in the Electrical Specification section provides the available output current versus case temperature and host board temperature.

#### Test Setup – Cold Plate

The product is tested in a box with two heater/coolers; one as a cold plate to control the temperature at the top of the product, another on the bottom side of the test board to control the host board temperature. The test board used is 130 x 160 mm in size with 1.6 mm thickness and 6 layers of 3 oz.

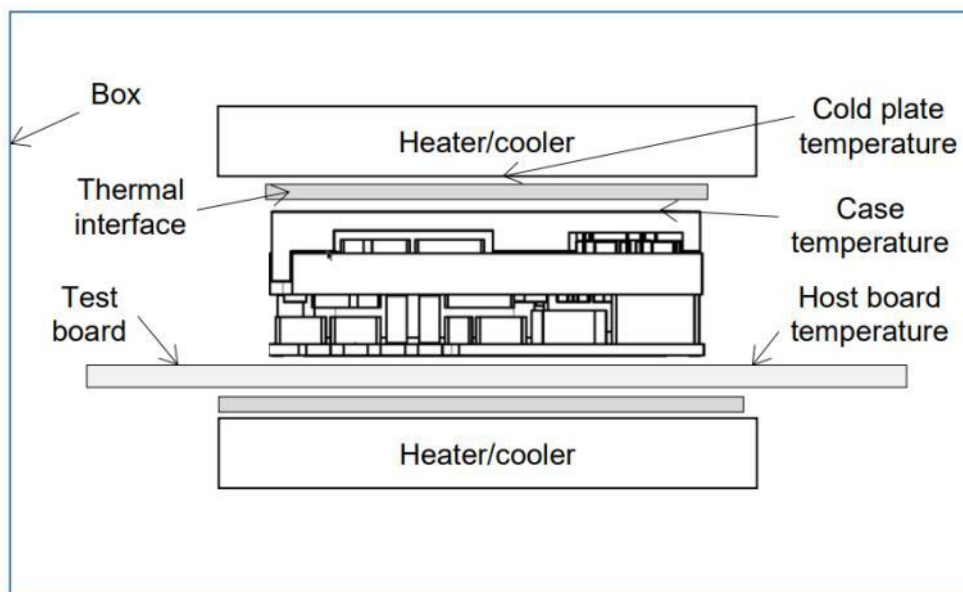

Test set-up: Cold plate

### Test Setup – Heatsink

For products mounted on a PCB with a heatsink attached, cooling is achieved both by conduction, from the pins to the host board, and through the heatsink mounted on top of the device. The wind speed and temperature are measured in a point upstream to the device. The output current derating graphs found later in this section provide the available output current vs. ambient air temperature and air velocity at  $V_{in} = 54\text{ V}$ .

For products using any form of heatsink structure a top spacing board and side airflow guides are used to ensure airflow hits the module and is not diverted away.

Distance between the tested device and the top space board and the side airflow guides are  $6.35\text{ mm} \pm 1\text{ mm}$ .

The product is tested on a  $185 \times 185\text{ mm}$ ,  $105\text{ }\mu\text{m}$  (3 oz), 6-layer test board mounted vertically in a wind tunnel.

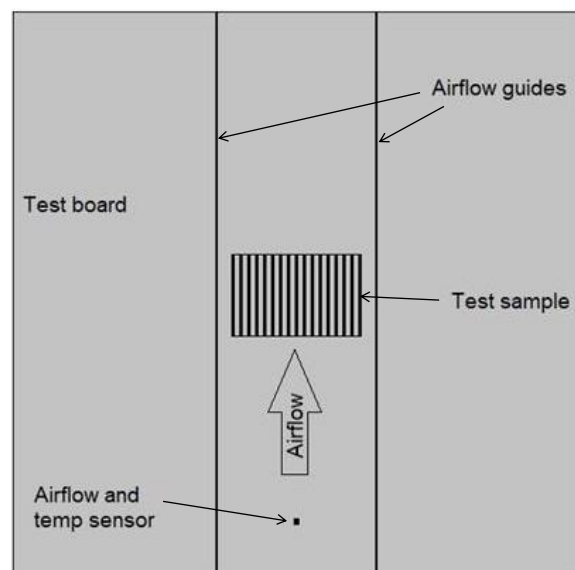
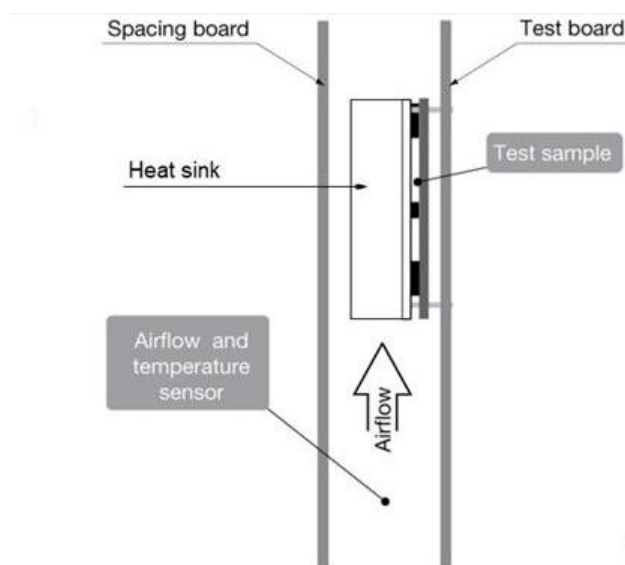

**Definition of product operating temperature**

Proper thermal conditions can be verified by measuring the temperature at position P1 as shown below. The temperature at this position ( $T_{P1}$ ) should not exceed the maximum temperatures in the table below. The number of measurement points may vary with different thermal design and topology. Temperatures above maximum  $T_{P1}$ , measured at the reference point P1 are not allowed and may cause permanent damage.

Position	Description	Max. Temp.
P1	PCB Bottom side	$T_{P1} = 125\text{ °C}$

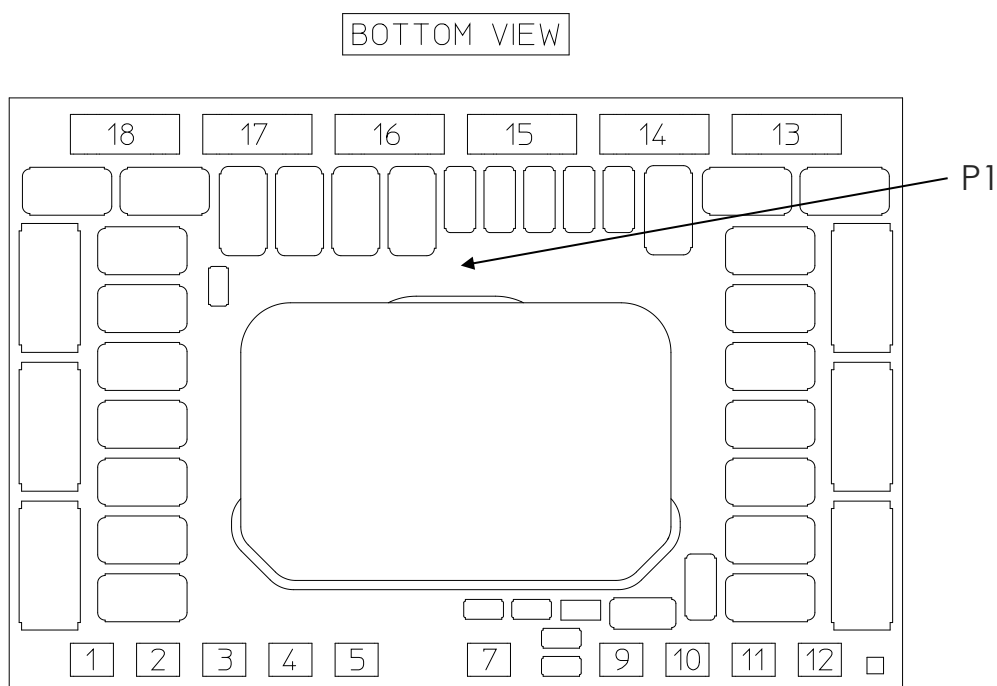

## Thermal graphs

### Output Power derating

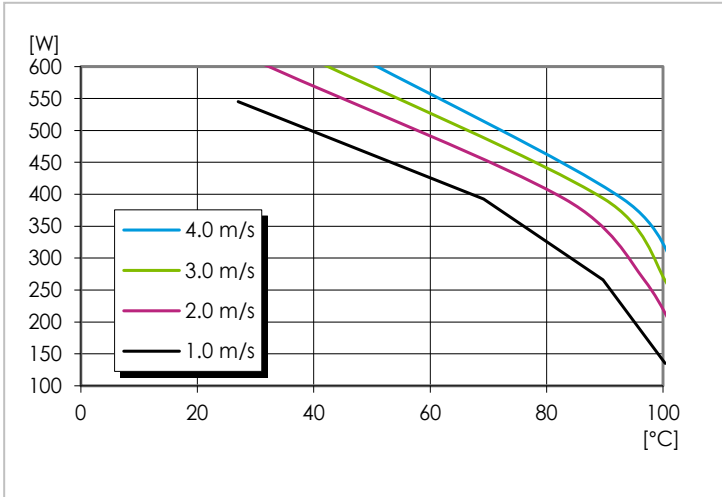

Figure 15: Max average output power vs. windspeed. Using ICK S 32 x 32 x 10 from Fischer.

### Output Power derating

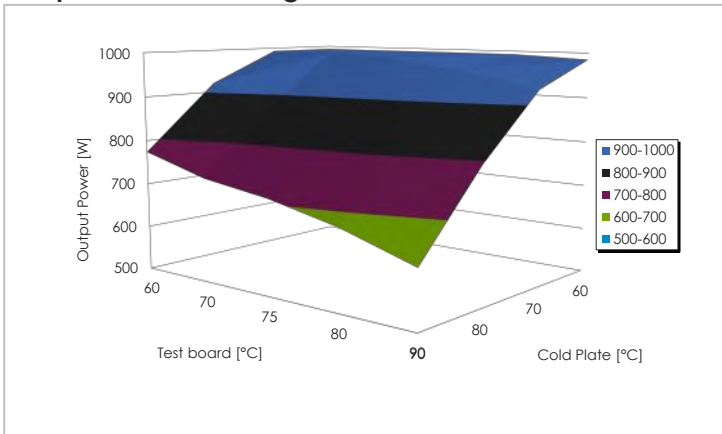

Figure 16: Max output power vs. cold plate temperature and host board temperature. Thermal interface material top 2.0 mm, 8 W/mK, bottom 1.0 mm, 8 W/mK.

For more information, please refer to our [thermal models](#) on the website.

## Peak Power

### Peak power capability

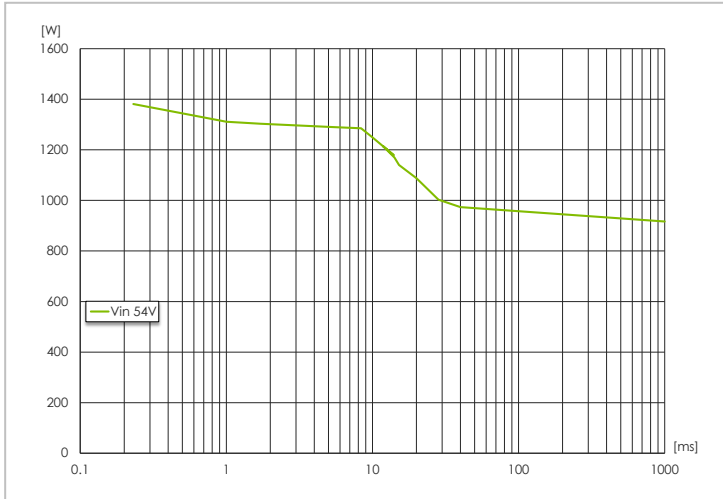

Figure 16: Max peak output current vs pulse duration and PMBus monitored temperature when pulse starts. Initial  $I_{out} = 90$  A. Limit given by max internal junction temperature (150 °C) of hotspot component.

## Part 5: Packaging

### Packaging information

The products are delivered in antistatic carrier tape (EIA 481 standard).

Carrier Tape Specifications	
<b>Material</b>	Antistatic PS
<b>Surface resistance</b>	$10^7 < \text{ohm/square}$
<b>Bakability</b>	Tape cannot be baked
<b>Tape width, W</b>	44 mm [1.73 inch]
<b>Pocket pitch, P1</b>	32 mm [1.26 inch]
<b>Pocket depth, K0</b>	8.9 mm [0.35 inch]
<b>Reel diameter</b>	330 mm [13 inch]
<b>Reel capacity</b>	150 products/reel
<b>Reel weight</b>	2.2kg/full reel

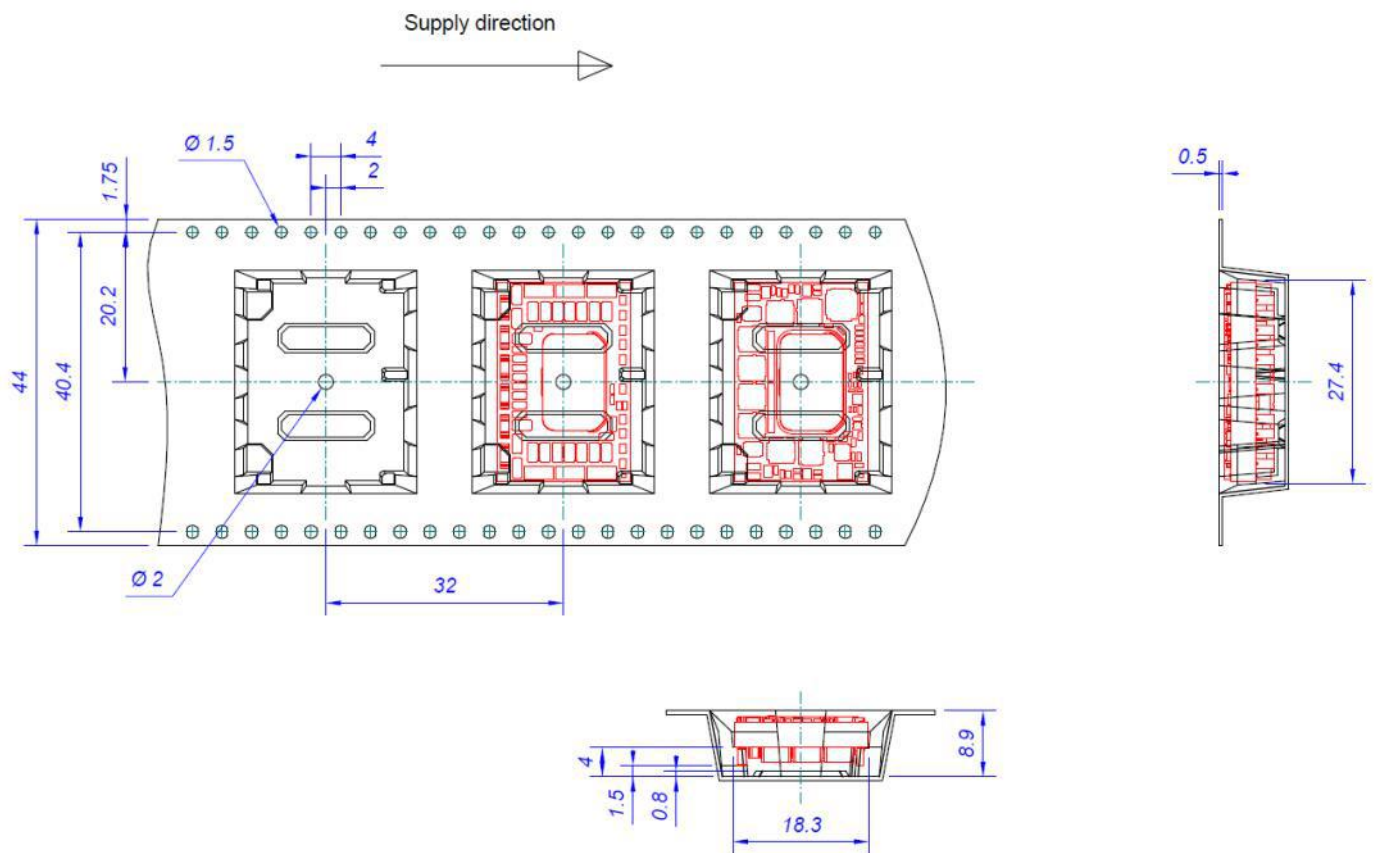

**Part 6: Revision history****Revision table**

Revision number	revision change	date	revisor
Rev. A	First release.	2025-04-XX	Karmjoh
Rev. B	Updated picture of product.	2025-04-22	Karjnils
Rev. C	Fixing typo.	2025-04-23	Karjnils
Rev. D	Adding order number example on page 2.	2025-04-24	Karjnils
Rev. E	Added Liquid cooling thermal graphs and the Liquid Cooling Setup, pages 12, 13, 15.	2025-04-29	Karjlind

# flex<sup>®</sup>

Flex Power Modules, a business line of Flex, is a leading manufacturer and solution provider of scalable DC/DC converter primarily serving the data processing, communications, industrial and transportation markets. Offering a wide range of both isolated and non-isolated solutions, its digitally-enabled DC/DC converters include PMBus compatibility supported by the powerful [Flex Power Designer](#).



## TECHNICAL REFERENCE DOCUMENT: DESIGN & APPLICATION GUIDELINES

### Operating Information

#### Input Voltage

The input voltage range 40 to 60 V (dc) meets the requirements for normal input voltage range in 54 V systems, 40V to 60 V.

Short duration transient disturbances can occur on the DC distribution and input of the product when a short circuit fault occurs on the equipment side of a protective device (fuse or circuit breaker). The voltage level, duration and energy of the disturbance are dependent on the particular DC distribution network characteristics and can be sufficient to damage the product unless measures are taken to suppress or absorb this energy. The transient voltage can be limited by capacitors and other energy absorbing devices like zener diodes connected across the positive and negative input conductors at strategic points in the distribution network. The end-user must secure that the transient voltage will not exceed the value stated in the Absolute maximum ratings.

#### Turn on and off input voltage

The product monitors the input voltage and will turn on and turn off at configured thresholds (see Electrical Specification). The turn-on input voltage threshold, defined by command VIN\_ON (0x35), is set higher than the corresponding turn-off threshold, defined by command VIN\_OFF (0x36). Hence, there is a hysteresis between turn-on and turn-off input voltage levels.

#### Input voltage transient

The end-user must secure that the transient voltage will not exceed the value stated in the *Datasheet under Absolute maximum ratings* of each product.

#### Input and Output Impedance

The impedance of both the input source and the load will interact with the impedance of the product. It is important that the input source has low characteristic impedance. The electrolytic capacitors will be degraded in low temperature. The needed input capacitance in low temperature should be equivalent to minimum recommended input and output capacitance at 20 °C. The performance in some applications can be enhanced by addition of external capacitance as described under External decoupling capacitors. If the input voltage source contains significant inductance, the addition of a low ESR ceramic capacitor of 22 – 100 µF capacitor across the input of the product will ensure stable operation. The minimum required capacitance value depends on the output power and the input voltage. The higher output power the higher input capacitance is needed.

## External decoupling capacitors

When powering loads with significant dynamic current requirements, the voltage regulation at the point of load can be improved by addition of decoupling capacitors at the load.

The most effective technique is to locate low ESR ceramic and electrolytic capacitors as close to the load as possible, using several parallel capacitors to lower the effective ESR. The ceramic capacitors will handle high-frequency dynamic load changes while the electrolytic capacitors are used to handle low frequency dynamic load changes. It is equally important to use low resistance and low inductance PCB layouts and cabling.

## Enabling Output Voltage

The output voltage is controlled by the EN pin and/or the PMBus command OPERATION, depending on the settings of the standard PMBus command ON\_OFF\_CONFIG. By default the output voltage is enabled by the EN pin using active high logic as default (OPERATION is ignored).

The EN pin in an open collector circuit without internal pull up or down resistor. The external resistor or control circuit must be able to pull EN pin voltage down below logic low threshold level (see Electrical Characteristics).

## Soft-start

Once enabled, the output voltage will ramp up to a 8:1 ratio of the input voltage. The ramp up is controlled monotonic and performed in three steps:

1. FETs start switching at minimum Duty cycle and switching frequency and updated based on  $V_{out}/V_{in}$  ratio with low energy transfer. The ramp is monitored to detect short circuits on the output.
2. The output voltage continues ramping up by increasing the switching frequency to nom.
3. Approaching the end of the soft start, the duty cycle is slowly increasing the duty cycle to nom.

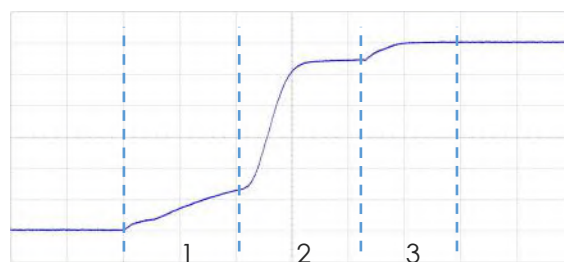

Ramp up waveform

Soft-stop can be disabled through the PMBus command ON\_OFF\_CONFIG (0x02).

The BMR 323 start-up sequence does not allow to load the module during startup. To fully load the BMR323 the controller should have initiated a Power Good signal. The startup time is input voltage and output capacitor dependant, for the maximum allowed output capacitance (see Electrical Specification).

Note: The soft-start sequence can not be changed by the user.

## Over temperature protection (OTP)

The product is protected from thermal overload by an internal over temperature shutdown function. The temperature sensor is located to provide a temperature representative of the module hot spot, see section Thermal Considerations in the datasheet.

The temperature is continuously monitored and when the temperature rises above the configured fault threshold level the product will respond as configured. The product can respond in several ways as follows:

1. Immediate shutdown of output voltage until the output voltage is re-enabled (latch). Default setting.
2. Ignore fault and continue operation. Not recommended.

The default OTP limit is specified in section Electrical Characteristics in the datasheet. The OTP fault and warning limits and response are configured using the PMBus commands OT\_FAULT\_LIMIT(0x4F), OT\_WARN\_LIMIT(0x51) and OT\_FAULT\_RESPONSE(0x50).

## Input Voltage Protections (IUVP, IOVP)

The product monitors the input voltage continuously. If the output voltage is enabled, and the input voltage falls below or rises above the configured threshold levels (see Electrical Specification) the product will respond as configured. The response can be configured in different ways:

1. Immediate shutdown of output voltage until the output voltage is re-enabled (latch). Default setting.
2. Ignore fault and continue operation. Not recommended.

The limits and fault responses are configured using the PMBus commands:

VIN\_UV\_WARN\_LIMIT(0x58), VIN\_UV\_FAULT\_LIMIT(0x59), VIN\_UV\_FAULT\_RESPONSE(0x5A),  
VIN\_OV\_WARN\_LIMIT(0x57), VIN\_OV\_FAULT\_LIMIT(0x55), VIN\_OV\_FAULT\_RESPONSE(0x56).

## Output Voltage Protections (UVP, OVP)

The product includes functionality for under and over voltage warnings and protection of the output voltage. The product can be configured to respond in different ways when the UVP/OVP fault limit is passed:

1. Immediate shutdown of output voltage until the output voltage is re-enabled (latch). Default setting.
2. Ignore fault and continue operation. Not recommended.

The limits and fault responses are configured using the PMBus commands:

VOUT\_UV\_WARN\_LIMIT(0x43), VOUT\_UV\_FAULT\_RESPONSE(0x45), VOUT\_UV\_FAULT\_LIMIT(0x44),  
VOUT\_OV\_WARN\_LIMIT(0x42), VOUT\_OV\_FAULT\_RESPONSE(0x41), VOUT\_OV\_FAULT\_LIMIT(0x40).

For more information, see *Technical Reference Document: PMBus*.

## Pre-bias start-up

The product has a pre-bias start up functionality and will not sink current during start up if a pre-bias source is present at the output terminals. If the pre-bias voltage is lower than the target value, the product will ramp up to the target value.

## Power supply sequencing and module enabling

The module should only be started using this defined sequences.

1. VCC, VIN and lastly EN.

It is vital that the time from where VCC is applied to when VIN/EN is activated is minimum 50ms. This timing is important in order to allow the controller to start the module.

## Over current protection (OCP)

The product includes robust current limiting functionality for protection at overload at continuous operation as well as transients over current protections. The over current protection and its fault response can be configured using Flex Power Designer software. For more information, see *Technical Reference Document: PMBus*.

The OCP functions can be divided into three parts.

1. Fast OCP, MFR\_IOUT\_OC\_FAST\_FAULT\_LIMIT (0xD1).
2. OCP, IOUT\_OC\_FAULT\_LIMIT (0x46).
3. A Moving Average, MFR\_IOUT\_AVG\_OC\_FAULT\_LIMIT (0xD0), see figure below.

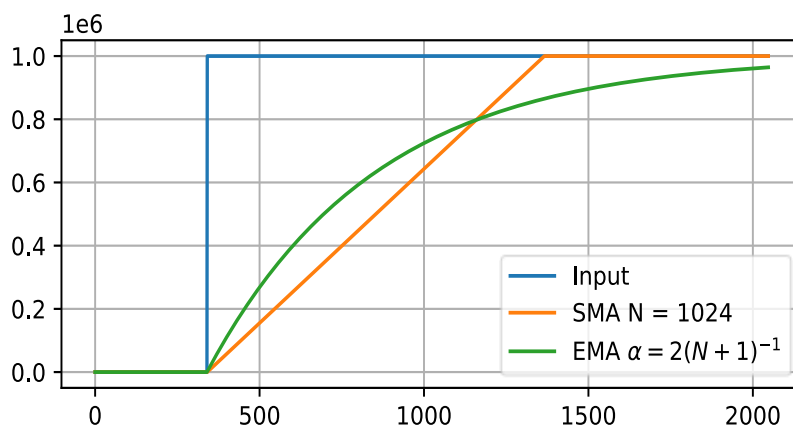

Demonstration of the behaviour of Simple Moving Average (SMA) and EMA for a step-function input

## Short circuit protection

During soft start the output voltage ramp is continuously monitored to detect a short circuit on the output. If the output voltage is not rising as expected, switching will stop and raise Startup OC fault. When there is a short circuit during operation, the module is protected by Over Current Protection.

## Power good

The power good pin (PG) indicates when the product is ready to provide output voltage to the load. After initialization, the PG pin is asserted low (open drain) until the output voltage is enabled and the soft-start procedure has finalized. The product also provides a power good flag in the STATUS\_WORD command that indicates the output voltage is within a specified tolerance of its target level and no-fault condition exists.

By default, the PG pin is configured as open drain output, but it is also possible to set the output in push/pull mode by the command MFR\_MULTI\_PIN\_CONFIG (0xF9). The polarity is by default configured to active high, the polarity of PG can be set to active low using the command FW\_CONFIG\_PMBUS (0xC9).

### Note on PG pin:

It is not recommended to use push-pull when paralleling PG-pins.

## Peak power considerations

The DC/DC converter has a peak power level warning in the datasheet. This in order to handle higher power than the thermal design power (TDP) for the converter. The Peak power level is also set in consideration of overshoot from a fast transient, tested from 0 to peak current with a specified di/dt. Thus a higher peak power, up to few standard OCP level, can be achieved but for a shorter period of time. Faster di/dt and higher peak load than specified, might cause current overshoot resulting in OCP fault.

For further assistance, contact your local Flex Power Modules' representative or email us to [pm.info@flex.com](mailto:pm.info@flex.com)

## Switching frequency

The product is optimized at the frequency given in the *Datasheet* under part 1- Electrical Specification. The frequency can not be changed by the user. Please contact your local Flex Power Modules FAE for more details.

## Multi pin configurations

The MFR\_MULTI\_PIN\_CONFIG (0xF9) command can be re-configured using the PMBus interface to enable or disable different functions and set the pin configuration of the digital header.

For more information, see *Technical Reference Document: PMBus*.

## Output ripple and noise

Output ripple and noise measured according to figure below using *evaluation board ROA 170286*. See Design Note 022 for detailed information

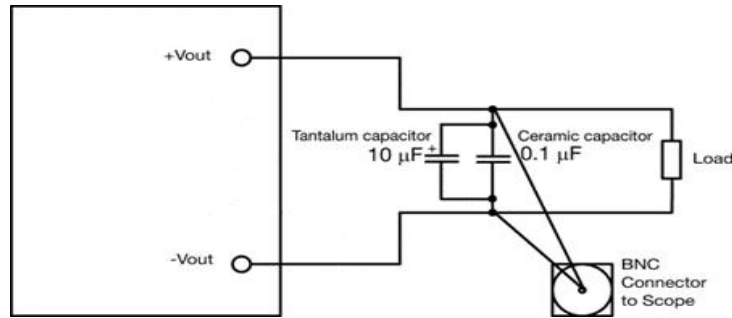

Output ripple and noise test setup

## Non-Volatile Memory (NVM)

The product incorporates two Non-Volatile Memory areas for storage of the PMBus command values; the Default NVM and the User NVM. The Default NVM is pre-loaded with Flex factory default values. The Default NVM is write-protected and can be used to restore the Flex factory default values through the command `RESTORE_DEFAULT_ALL (0x12)`.

The User NVM is pre-loaded with Flex factory default values. The User NVM is writable and open for customization. The values in NVM are loaded during initialization according to section Initialization Procedure, where after commands can be changed through the PMBus Interface.

The module contains a one-time programmable memory (OTP) used to store configuration settings, which will not be programmed into the device OTP automatically. The `STORE_USER_ALL(0x15)` commands must be used to commit the current settings are transferred from RAM to OTP as device defaults.

Note: The one-time programmable memory (OTP) has limited storing times, frequent use of `STORE_USER_ALL` command can lead to memory space exhaustion.

## Parallel operation

Two or more products may be paralleled for redundancy. The products provide output voltage droop resistance in secondary transformer winding, which enables direct paralleling. To achieve optimum operation when paralleling modules, it is important to ensure the same PCB routing path resistances between the input terminals and merged output terminals. The output voltage will decrease with increased load current. This feature allows the product to be connected in parallel and share current within 10% accuracy at max output power. This means that up to 90% of max rated current from each module can be utilized.

In applications with several modules in parallel, the PG signal of all modules should be connected together. Further, load shall not be applied unless PG signal is high (= all modules have successfully ramped up).

For further information please contact your local Flex Power Modules' representative or email us at [pm.info@flex.com](mailto:pm.info@flex.com).

## Power management

### PMBUS overview

This product is equipped with a PMBus interface. The product incorporates a wide range of readable and configurable power management features that are simple to implement with a minimum of external components. Additionally, the product includes protection features that continuously safeguard the load from damage due to unexpected system faults. The following product parameters can continuously be monitored by a host: Input voltage, output voltage/current and internal temperature.

The product is delivered with a default configuration suitable for a wide range operation in terms of input voltage, output voltage, and load. The configuration is stored in an internal Non-Volatile Memory (NVM). All power management functions can be reconfigured using the PMBus interface.

Throughout this document, different PMBus commands are referenced. The Flex Power Designer software suite can be used to configure and monitor this product via the PMBus interface. More information is found on [our website](#).

### SMBus interface

This product provides a PMBus digital interface that enables the user to configure many aspects of the device operation as well as to monitor the input and output voltages, output current and device temperature. The product can be used with any standard two-wire I<sup>2</sup>C (master must allow for clock stretching) or SMBus host device. In addition, the product is compatible with SMBus version 3.0 and includes an SALERT line to help mitigate bandwidth limitations related to continuous fault monitoring. The product supports 100 kHz and 400 kHz bus clock frequency only. The SMBus signals, SCL, SDA and SALERT require passive pull-up resistors as stated in the SMBus Specification. Pull-up resistors are required to guarantee the rise time as follows:

$$\tau = R_p C_p \leq 1 \mu\text{s}$$

where  $R_p$  is the pull-up resistor value and  $C_p$  is the bus load. The maximum allowed bus load is 400 pF. The pull-up resistor should be tied to an external supply between 2.7 to 3.8 V, which should be present prior to or during power-up. If the proper power supply is not available, voltage dividers may be applied. Note that in this case, the resistance in the equation above corresponds to parallel connection of the resistors forming the voltage divider.

PEC (Packet Error Check) is not supported.

## PMBus addressing

The following figure and table show recommended resistor values with min and max range for hard-wiring PMBus addresses (series E96, 1% tolerance resistor suggested).

The XADDR pin can be configured with a resistor to GND according to the following table.

Index.	1% RADDR [kΩ]	PMBus Address = 0x60 + Index
0	0	0x60
1	0.576	0x61
2	1.05	0x62
3	1.62	0x63
4	2.26	0x64
5	3.16	0x65
6	4.22	0x66
7	5.76	0x67
8	7.68	0x68
9	10.5	0x69
A	14.3	0x6A
B	20	0x6B
C	28.4	0x6C
D	46.4	0x6D
E	86.6	0x6E
F	205	0x6F

The PMBus address is calculated as:

$$\text{PMBus Address} = \text{Base Address} + \text{Index}$$

where the base address is defined by bits [31:24] in the PMBus command `PMBUS_ADDRESS` (0xC9). The standard default value for the base address is (0x60), giving an address range from (0x60) to (0x6F). Specific product variants may have a different default value.

If changing the base address, the change will take effect after the VCC voltage is cycled.

## I2C/SMBus timing

The setup time,  $t_{\text{set}}$ , is the time data, SDA, must be stable before the rising edge of the clock signal, SCL. The hold time  $t_{\text{hold}}$ , is the time data, SDA, must be stable after the rising edge of the clock signal, SCL. If these times are violated incorrect data may be captured or meta-stability may occur and the bus communication may fail. All standard SMBus protocols must be followed, including clock stretching.

This product supports the BUSY flag in the status commands to indicate product being too busy for SMBus response. A bus-free time delay between every SMBus transmission (between every stop & start condition) must occur. Refer to the SMBus specification, for SMBus electrical and timing requirements.

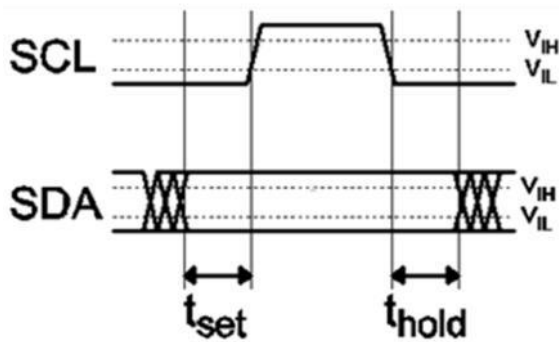

Set-up and hold timing diagram

## Monitoring via PMBus

It is possible to continuously monitor a wide variety of parameters through the PMBus interface. These include, but are not limited to, the parameters listed in the table below.

Parameter	PMBus command
Input voltage	READ_VIN
Output voltage	READ_VOUT
Output current	READ_IOUT
Temperature	READ_TEMPERATURE_1

These PMBus commands are updated every 0.25 ms.

The temperature sensor is located to provide a temperature reading representative of the module hot spot P1, see section Thermal Considerations in the datasheet.

## Monitoring faults

The user may read PMBus status commands to find out what fault or warning condition occurred, see table below:

Fault and warning status	PMBus command
Overview, Power Good	STATUS_BYTE STATUS_WORD
Output voltage level	STATUS_VOUT
Output current level	STATUS_IOUT
Input voltage level	STATUS_INPUT
Temperature level	STATUS_TEMPERATURE
PMBus communication	STATUS_CML
Miscellaneous	STATUS_MFR_SPECIFIC

Status bits are asserted until faults and/or warnings are cleared by the CLEAR\_FAULTS (0x03) command. A re-enable of the output voltage will not clear the status bits.

## TECHNICAL REFERENCE DOCUMENT: GENERAL INFORMATION

### Compatibility with RoHS requirements

The products are compatible with the relevant clauses and requirements of the *RoHS directive 2011/65/EU* and *2015/863* have a maximum concentration value of 0.1% by weight in homogeneous materials for lead, mercury, hexavalent chromium, PBB, PBDE, DEHP, BBP, DBP, DIBP and of 0.01% by weight in homogeneous materials for cadmium.

Exemptions in the RoHS directive utilized in Flex Power Modules products are found in the Statement of Compliance document.

Flex Power Modules fulfills and will continuously fulfill all its obligations under regulation (EC) No 1907/2006 concerning the registration, evaluation, authorization and restriction of chemicals (REACH) as they enter into force and is through product materials declarations preparing for the obligations to communicate information on substances in the products.

### Quality statement

The products are designed and manufactured in an industrial environment where quality systems and methods like [ISO 9001](#), [ISO 14001](#), [ISO 45001](#), *Six Sigma*, and *SPC* are intensively in use to boost the continuous improvements strategy. Infant mortality or early failures in the products are screened out and they are subjected to an ATE-based final test. Conservative design rules, design reviews and product qualifications, plus the high competence of an engaged workforce, contribute to the high quality of the products.

### Warranty

Warranty period and conditions are defined in *Flex Power Modules' General Terms and Conditions of Sales*.

### Limitation of Liability

Flex Power Modules does not make any other warranties, expressed or implied including any warranty of merchantability or fitness for a particular purpose (including, but not limited to, use in life support applications, where malfunctions of product can cause injury to a person's health or life).

## Product qualification specifications

Characteristics			
External visual inspection	IPC-A-610		
Temperature shock test (Temperature cycling)	IEC 60068-2-14 Na	Temperature range Number of cycles Dwell/transfer time	-40 to 125°C 700 15 min/0-1 min
Cold (in operation)	IEC 60068-2-1 Ad	Temperature T <sub>A</sub> Duration	-45°C 72 h
Damp heat	IEC 60068-2-67 Cy	Temperature Humidity Duration	85°C 85% RH 1000 hours
Dry heat	IEC 60068-2-2 Bd	Temperature Duration	125°C 1000 h
Electrostatic discharge susceptibility	IEC 61340-3-1, JESD 22-A114 IEC 61340-3-2, JESD 22-A115	Human body model (HBM) Machine Model (MM)	Class 2, 2000 V Class 3, 200 V
Immersion in cleaning sol- vents	IEC 60068-2-45 XA, method 2	Water Flux Cleaner Isopropyl alcohol	55°C 23°C 35°C
Mechanical shock	IEC 60068-2-27 Ea	Peak acceleration Duration	100 g 6 ms
Moisture reflow sensitivity	J-STD-020E	Level 1 (SnPb-eutectic) Level 3 (Pb Free)	225°C 245°C
Operational Life test Rapid Temp.	MIL-STD-202G, method 108A	Duration	1000 h
Robustness of terminations	IEC 60068-2-21 Test Ue1	Surface mount products	All leads
Solderability	IEC 60068-2-20 test Ta	Preconditioning Temperature, Pb-free	Steam ageing 245°C
Vibration, broad band ran- dom	IEC 60068-2-64 Fh, method 1	Frequency Spectral density Duration	10 to 500 Hz 0.07 g <sup>2</sup> /Hz 10 min in each direction

## TECHNICAL REFERENCE DOCUMENT: SOLDERING

### Reflow soldering profile for surface mount

Products intended for surface mount assembly are qualified for use in a Pb-free forced convection or vapor phase reflow soldering process.

For Pb-free solder processes, a pin temperature ( $T_{pin}$ ) in excess of the solder melting temperature ( $T_L$ , 217 to 221°C for SnAgCu solder alloys) for more than 60 seconds and a peak temperature of 245°C on all pins is recommended to ensure a reliable solder joint.

$T_L$  is the typical solder melting (liquidous) temperature  
 $T_{product}$  is measured on the power module's hotspot  
 $T_{pin}$  is measured on the power module output power pins solder joints at the customer board

General reflow process specification		Pb-free, SAC305
Average ramp-up rate ( $T_{product}$ )		3 °C/s max
Typical solder melting temp.	$T_L$	217 °C
Min/Max. reflow time above $T_L$	$T_{pin}$	60 –150 s
Min. pin temp.	$T_{pin}$	235 °C
Peak product temp.	$T_{product}$	245 °C
Average ramp-down ( $T_{product}$ )		6°C/s max
Max. time 25° C to peak		8 minutes

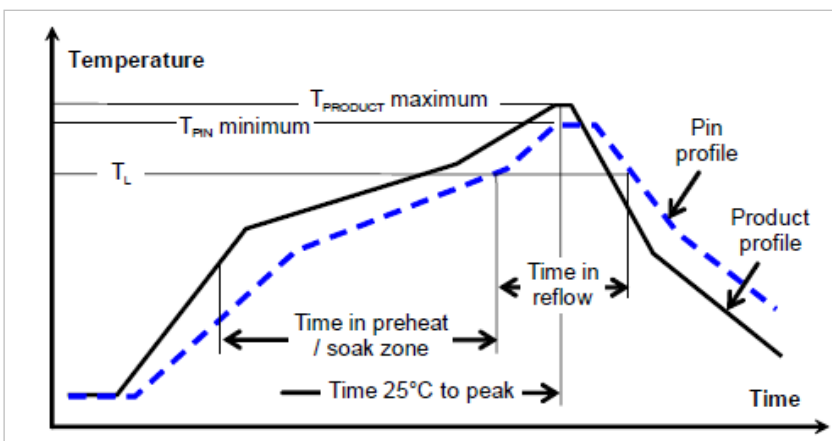

Typical soldering profile

## Moisture reflow classification

For Pb-free reflow solder processes, the product is qualified for MSL 3 according to IPC/JEDEC standard J-STD-020C.

## Dry pack information

Using products in high temperature reflow soldering processes requires dry pack storage and handling. Products intended for Pb-free reflow soldering processes are delivered in standard moisture barrier bags according to IPC/JEDEC standard J-STD-033 (handling, packing, shipping and use of moisture/reflow sensitivity surface mount devices). In case the products have been stored in an uncontrolled environment and no longer can be considered dry, floor life according to MSL 3, the modules must be baked according to J-STD-033.

## Post solder cleaning

A no-clean flux is recommended to avoid entrapment of cleaning fluids in cavities inside the product or between the product and the host board, since cleaning residues may affect long term reliability and isolation voltage.

## TECHNICAL REFERENCE DOCUMENT: SAFETY

### Safety specifications

Flex Power Modules' DC/DC converters and DC/DC regulators are designed in accordance with the safety standards *IEC 62368-1*, *EN 62368-1* and *UL 62368-1 Audio/video, information and communication technology equipment - Part 1: Safety requirements*

IEC/EN/UL 62368-1 contains requirements to prevent injury or damage due to the following hazards:

- Electrical shock
- Electrically-caused fire
- Injury caused by hazardous substances
- Mechanically-caused injury
- Skin burn
- Radiation-caused injury

On-board DC/DC converters, Power Interface Modules and DC/DC regulators are defined as component power supplies. As components they cannot fully comply with the provisions of any safety requirements without "conditions of acceptability". Clearance between conductors and between conductive parts of the component power supply and conductors on the board in the final product must meet the applicable safety requirements. Certain conditions of acceptability apply for component power supplies with limited stand-off (please refer to the *Datasheet under Mechanical Information* for further information). It is the responsibility of the installer to ensure that the final product housing these components complies with the requirements of all applicable safety standards and regulations for the final product.

Component power supplies for general use shall comply with the requirements in *IEC/EN/UL 62368-1*. Product related standards, e.g. *IEEE 802.3af Power over Ethernet*, and *ETS-300132-2 Power interface at the input to telecom equipment, operated by direct current (dc)* are based on *IEC/EN/UL 62368 -1* with regards to safety.

All Flex Power Modules' DC/DC converters, Power Interface Modules and DC/DC regulators are *UL 62368-1* recognized and certified in accordance with *EN 62368-1*. The flammability rating for all construction parts of the products meet requirements for V-0 class material according to *IEC 60695 -11 -10*, Fire hazard testing, test flames – 50 W horizontal and vertical flame test methods.

## Technical Reference PMBus - BMR 323 X000/001

This appendix contains a detailed reference of the PMBus commands supported by the product.

### Data Formats

The products make use of a few standardized numerical formats, along with custom data formats. A detailed walkthrough of the above formats is provided in AN304, as well as in sections 7 and 8 of the PMBus Specification Part II. The custom data formats vary depending on the command, and are detailed in the command description.

### Standard Commands

The functionality of commands with code 0x00 to 0xCF is usually based on the corresponding command specification provided in the PMBus Standard Specification Part II (see Power System Management Bus Protocol Documents below). However there might be different interpretations of the PMBus Standard Specification or only parts of the Standard Specification applied, thus the detailed command description below should always be consulted.

### Forum Websites

The System Management Interface Forum (SMIF)

<http://www.powersig.org/>

The System Management Interface Forum (SMIF) supports the rapid advancement of an efficient and compatible technology base that promotes power management and systems technology implementations. The SMIF provides a membership path for any company or individual to be active participants in any or all of the various working groups established by the implementer forums.

Power Management Bus Implementers Forum  
(PMBUS-IF)

<http://pmbus.org/>

The PMBUS-IF supports the advancement and early adoption of the PMBus protocol for power management. This website offers recent PMBus specification documents, PMBus articles, as well as upcoming PMBus presentations and seminars, PMBus Document Review Board (DRB) meeting notes, and other PMBus related news.

### PMBus – Power System Management Bus Protocol Documents

These specification documents may be obtained from the PMBUS-IF website described above. These are required reading for complete understanding of the PMBus implementation. This appendix will not re-address all of the details contained within the two PMBus Specification documents.

Specification Part I – General Requirements Transport And Electrical Interface

Includes the general requirements, defines the transport and electrical interface and timing requirements of hard wired signals.

Specification Part II – Command Language

Describes the operation of commands, data formats, fault management and defines the command language used with the PMBus.

### SMBus – System Management Bus Documents

System Management Bus Specification, Version 2.0, August 3, 2000

This specification specifies the version of the SMBus on which Revision 1.2 of the PMBus Specification is based. This specification is freely available from the System Management Interface Forum Web site at:

<http://www.smbus.org/specs/>

## PMBus Command Summary and Factory Default Values of Standard Configuration

The factory default values provided in the table below are valid for the Standard configuration. Factory default values for other configurations can be found using the Flex Power Designer tool.

Code	Name	Data Format	Factory Default Value Standard Configuration BMR323X000/001 R1	Min Set Value	Max Set Value	Unit	
0x01	OPERATION	R/W Byte	0x80				
0x02	ON_OFF_CONFIG	R/W Byte	0x17				
0x03	CLEAR_FAULTS	Send Byte					
0x10	WRITE_PROTECT	R/W Byte					
0x12	RESTORE_DEFAULT_ALL	Send Byte					
0x15	STORE_USER_ALL	Send Byte					
0x16	RESTORE_USER_ALL	Send Byte					
0x19	CAPABILITY	Read Byte					
0x1B	SMBALERT_MASK_VOUT (STATUS_VOUT)	SMBAlert Mask	0x00				
0x1B	SMBALERT_MASK_IOUT (STATUS_IOUT)	SMBAlert Mask	0x00				
0x1B	SMBALERT_MASK_INPUT (STATUS_INPUT)	SMBAlert Mask	0x00				
0x1B	SMBALERT_MASK_TEMPERATU RE (STATUS_TEMPERATURE)	SMBAlert Mask	0x00				
0x1B	SMBALERT_MASK_CML (STATUS_CML)	SMBAlert Mask	0x00				
0x1B	SMBALERT_MASK_OTHER (STATUS_OTHER)	SMBAlert Mask	0x00				
0x1B	SMBALERT_MASK_MFR_SPECIFI C (STATUS_MFR_SPECIFIC)	SMBAlert Mask	0x00				
0x20	VOUT_MODE	Read Byte	0x14				
0x35	VIN_ON	R/W Word	0xE250	37.00		V	
0x36	VIN_OFF	R/W Word	0xE230	35.00		V	
0x37	INTERLEAVE	R/W Word	0x0120				
0x39	IOUT_CAL_OFFSET	R/W Word	Unit Specific				
0x40	VOUT_OV_FAULT_LIMIT	R/W Word	0x8400	8.25	0	16	V
0x41	VOUT_OV_FAULT_RESPONSE	R/W Byte	0x80				
0x42	VOUT_OV_WARN_LIMIT	R/W Word	0x7C02	7.75	0	16	V
0x43	VOUT_UV_WARN_LIMIT	R/W Word	0x219A	2.10	0	16	V
0x44	VOUT_UV_FAULT_LIMIT	R/W Word	0x2000	2.00	0	16	V
0x45	VOUT_UV_FAULT_RESPONSE	R/W Byte	0x80				
0x46	IOUT_OC_FAULT_LIMIT	R/W Word	0xF398	230.00	0	255	A
0x47	IOUT_OC_FAULT_RESPONSE	R/W Byte	0xC0				
0x48	IOUT_OC_LV_FAULT_LIMIT	R/W Word	0x0000	0.00			V
0x4A	IOUT_OC_WARN_LIMIT	R/W Word	0x0082	130.00	0	255	A
0x4B	IOUT_UC_FAULT_LIMIT	R/W Word	0x07DD	-35.00			A
0x4C	IOUT_UC_FAULT_RESPONSE	R/W Byte	0x00				
0x4F	OT_FAULT_LIMIT	R/W Word	0x007D	125.00	-50	150	°C
0x50	OT_FAULT_RESPONSE	R/W Byte	0x80				
0x51	OT_WARN_LIMIT	R/W Word	0x005A	90.00	-50	150	°C
0x52	UT_WARN_LIMIT	R/W Word	0x0000	0.00	-50	150	°C
0x53	UT_FAULT_LIMIT	R/W Word	0xE4E0	-50.00	-50	150	°C
0x54	UT_FAULT_RESPONSE	R/W Byte	0x00				
0x55	VIN_OV_FAULT_LIMIT	R/W Word	0xF100	64.00	0	128	V



0xDA	MFR_READ_VAUX	Read Word					
0xDB	MFR_EVENT_INDEX	R/W Word					
0xDC	MFR_SELECT_TEMPERATURE_SE NSOR	R/W Byte	0x00				
0xE0	MFR_FLEX_FIRMWARE_CMD	R/W Block8					
0xE7	MFR_TEMP_COEFF	R/W Word	0x0090				
0xEA	MFR_IOUT_APC	R/W Word	Unit Specific				
0xF9	MFR_MULTI_PIN_CONFIG	R/W Word	0x0202				

**PMBus Command Details****OPERATION (0x01)**

Description: Sets the desired PMBus enable and margin operations.

Bit	Function	Description	Value	Function	Description
7:6	Enable	Make the device enable or disable.	00	Immediate Off	Disable Immediately without sequencing.
			01	Soft Off	Disable "Softly" with sequencing.
			10	Enable	Enable device to the desired margin state.
5:4	Margin	Select between margin high/low states or nominal output.	00	Nominal	Operate at nominal output voltage.
			01	Margin Low	Operate at margin low voltage set in VOUT_MARGIN_LOW.
			10	Margin High	Operate at margin high voltage set in VOUT_MARGIN_HIGH.
3:2	Act on Fault	Set 10b to act on fault or set to 01b to ignore fault.	01	Ignore Faults	Ignore Faults when in a margined state. The device will ignore appropriate overvoltage/undervoltage warnings and faults and respond as programmed by the warning limit or fault response command.
			10	Act on Faults	Act on Faults when in a margined state. The device will handle appropriate overvoltage/undervoltage warnings and faults and respond as programmed by the warning limit or fault response command.

**ON\_OFF\_CONFIG (0x02)**

Description: Configures how the device is controlled by the CONTROL pin and the PMBus.

Bit	Function	Description	Value	Function	Description
4	Powerup Operation	Sets the default to either operate any time power is present or for the on/off to be controlled by CONTROL pin and serial bus commands.	0	Enable Always	Unit powers up any time power is present regardless of state of the CONTROL pin, taking the RC configuration into account, see command 0xE3.
			1	Enable pin or PMBus	Unit does not power up until commanded by the CONTROL pin and OPERATION command.
3	PMBus Enable Mode	Controls how the unit responds to commands received via the serial bus.	0	Ignore PMBus	Unit ignores the on/off portion of the OPERATION command from serial bus.

			1	Use PMBus	To start, the unit requires that the on/off portion of the OPERATION command is instructing the unit to run.
2	Enable Pin Mode	Controls how the unit responds to the CONTROL pin.	0	Ignore pin	Unit ignores the CONTROL/Enable pin.
			1	Use pin	Unit requires the CONTROL pin to be asserted to start the unit.
1	Enable Pin Polarity	Polarity of the CONTROL pin.	0	Active Low	Enable pin will cause device to enable when driven low.
			1	Active High	Enable pin will cause device to enable when driven high.
0	Disable Action	CONTROL pin action when commanding the unit to turn off.	0	Soft Off	Use the programmed turn off delay and fall time.
			1	Imm. Off	Turn off the output and stop transferring energy to the output as fast as possible. The device's product literature shall specify whether or not the device sinks current to decrease the output voltage fall time.

**CLEAR\_FAULTS (0x03)**

Description: Clears all fault status bits

**WRITE\_PROTECT (0x10)**

Description: The WRITE\_PROTECT command is used to control writing to the PMBus device. The intent of this command is to provide protection against accidental changes. This command is not intended to provide protection against deliberate or malicious changes to a device's configuration or operation.

Bit	Description	Value	Function	Description
7:0	All supported commands may have their parameters read, regardless of the WRITE_PROTECT settings.	0x80	Disable all writes	Disable all writes except to the WRITE_PROTECT command.
		0x40	Enable operation	Disable all writes except to the WRITE_PROTECT, OPERATION and PAGE commands.
		0x20	Enable control and Vout commands	Disable all writes except to the WRITE_PROTECT, OPERATION, PAGE, ON_OFF_CONFIG and VOUT_COMMAND commands.
		0x00	Enable all commands	Enable writes to all commands.

**RESTORE\_DEFAULT\_ALL (0x12)**

Description: Commands the device to restore its configuration from the Default Store.

**STORE\_USER\_ALL (0x15)**

Description: Stores, at the USER level, all PMBus values that were changed since the last restore command.

**RESTORE\_USER\_ALL (0x16)**

Description: Restores PMBus settings that were stored using STORE\_USER\_ALL. This command is automatically performed at power up.

**CAPABILITY (0x19)**

Description: This command provides a way for a host system to determine some key capabilities of a PMBus device.

Bit	Function	Description	Value	Function	Description
7	Packet Error Checking	Packet error checking.	0	Not Supported	Packet Error Checking not supported.
			1	Supported	Packet Error Checking is supported.
6:5	Maximum Bus Speed	Maximum bus speed.	00	100kHz	Maximum supported bus speed is 100 kHz.
			01	400kHz	Maximum supported bus speed is 400 kHz.
			10	1MHz	Maximum supported bus speed is 1 MHz.
4	Smbalert	SMBALERT	00	No Smbalert	The device does not have a SMBALERT# pin and does not support the SMBus Alert Response protocol.
			01	Have Smbalert	The device does have a SMBALERT# pin and does support the SMBus Alert Response protocol.
3	Numeric Format	Numeric format.	0	LINEAR or DIRECT Format	Numeric data is in LINEAR or DIRECT format.
			1	IEEE Half Precision Floating Point Format	Numeric data is in IEEE half precision floating point format.
2	AVSBus Support	AVSBus support.	0	AVSBus Not Supported	AVSBus not supported.
			1	AVSBus Supported	AVSBus supported.

**SMBALERT\_MASK\_VOUT (0x1B)**

Status Registers: STATUS\_VOUT (0x7A)

Description: SMBALERT\_MASK bits for the STATUS\_VOUT command. The SMBALERT\_MASK command may be used to prevent a warning or fault condition from asserting the SALERT output signal.

Bit	Function	Description	Value	Function	Description
7	Vout Overvoltage Fault		0	Pull SALERT	
			1	Ignore	
6	Vout Overvoltage Warning		0	Pull SALERT	
			1	Ignore	
5	Vout Undervoltage Warning		0	Pull SALERT	
			1	Ignore	
4	Vout Undervoltage Fault		0	Pull SALERT	
			1	Ignore	

3	Vout Max Warning		0	Pull SALERT	
			1	Ignore	
2	Ton Max Fault		0	Pull SALERT	
			1	Ignore	
1	Toff Max Warning		0	Pull SALERT	
			1	Ignore	

**SMBALERT\_MASK\_IOUT (0x1B)**

Status Registers: STATUS\_IOUT (0x7B)

Description: SMBALERT\_MASK bits for the STATUS\_IOUT command. The SMBALERT\_MASK command may be used to prevent a warning or fault condition from asserting the SALERT output signal.

Bit	Function	Description	Value	Function	Description
7	Iout Overcurrent Fault		0	Pull SALERT	
			1	Ignore	
6	Iout Overcurrent And Low Voltage Fault		0	Pull SALERT	
			1	Ignore	
5	Iout Over Current Warning		0	Pull SALERT	
			1	Ignore	
4	Iout Undercurrent Fault		0	Pull SALERT	
			1	Ignore	

**SMBALERT\_MASK\_INPUT (0x1B)**

Status Registers: STATUS\_INPUT (0x7C)

Description: SMBALERT\_MASK bits for the STATUS\_INPUT command. The SMBALERT\_MASK command may be used to prevent a warning or fault condition from asserting the SALERT output signal.

Bit	Function	Description	Value	Function	Description
7	Vin Overvoltage Fault		0	Pull SALERT	
			1	Ignore	
6	Vin Overvoltage Warning		0	Pull SALERT	
			1	Ignore	
5	Vin Undervoltage Warning		0	Pull SALERT	
			1	Ignore	
4	Vin Undervoltage Fault		0	Pull SALERT	
			1	Ignore	
3	Insufficient Vin		0	Pull SALERT	
			1	Ignore	

**SMBALERT\_MASK\_TEMPERATURE (0x1B)**

Status Registers: STATUS\_TEMPERATURE (0x7D)

Description: SMBALERT\_MASK bits for the STATUS\_TEMPERATURE command. The SMBALERT\_MASK command may be used to prevent a warning or fault condition from asserting the SALERT output signal.

Bit	Function	Description	Value	Function	Description
7	Overtemperature Fault		0	Pull SALERT	
			1	Ignore	

6	Overtemperature Warning		0	Pull SALERT	
			1	Ignore	
5	Undertemperature Warning		0	Pull SALERT	
			1	Ignore	
4	Undertemperature Fault		0	Pull SALERT	
			1	Ignore	

**SMBALERT\_MASK\_CML (0x1B)**

Status Registers: STATUS\_CML (0x7E)

Description: SMBALERT\_MASK bits for the STATUS\_CML command. The SMBALERT\_MASK command may be used to prevent a warning or fault condition from asserting the SALERT output signal.

Bit	Function	Description	Value	Function	Description
7	Invalid Or Unsupported Command Received		0	Pull SALERT	
			1	Ignore	
6	Invalid Or Unsupported Data Received		0	Pull SALERT	
			1	Ignore	
5	Packet Error Check Failed		0	Pull SALERT	
			1	Ignore	
4	Memory Fault Detected		0	Pull SALERT	
			1	Ignore	
3	Processor Fault Detected		0	Pull SALERT	
			1	Ignore	
1	Other Communication Fault		0	Pull SALERT	
			1	Ignore	
0	Memory Or Logic Fault		0	Pull SALERT	
			1	Ignore	

**SMBALERT\_MASK\_OTHER (0x1B)**

Status Registers: STATUS\_OTHER (0x7F)

Description: SMBALERT\_MASK bits for the STATUS\_OTHER command. The SMBALERT\_MASK command may be used to prevent a warning or fault condition from asserting the SALERT output signal.

Bit	Description	Value	Function	Description
0		0	Pull SALERT	
		1	Ignore	

**SMBALERT\_MASK\_MFR\_SPECIFIC (0x1B)**

Status Registers: STATUS\_MFR\_SPECIFIC (0x80)

Description: SMBALERT\_MASK bits for the STATUS\_MFR\_SPECIFIC command. The SMBALERT\_MASK command may be used to prevent a warning or fault condition from asserting the SALERT output signal.

Bit	Function	Description	Value	Function	Description
7	Sync Fault		0	Pull SALERT	
			1	Ignore	
6	Iout Average Overcurrent Fault		0	Pull SALERT	
			1	Ignore	

5	Iout Fast Overcurrent Fault	0	Pull SALERT
		1	Ignore
4	Short Circuit Protection Fault	0	Pull SALERT
		1	Ignore
3	Overtemperature2 Fault	0	Pull SALERT
		1	Ignore
2	Auxiliary Voltage Fault	0	Pull SALERT
		1	Ignore
1	Startup Over Current Fault	0	Pull SALERT
		1	Ignore
0	Overtemperature2 Warn	0	Pull SALERT
		1	Ignore

**VOUT\_MODE (0x20)**

Description: Controls how future VOUT-related commands parameters will be interpreted.

Bit	Function	Description	Format
4:0		Five bit two's complement EXPONENT for the MANTISSA delivered as the data bytes for VOUT_COMMAND in VOUT_LINEAR Mode, five bit VID code identifier per in VID Mode or always set to 00000b in Direct Mode.	Integer Signed

Bit	Function	Description	Value	Function	Description
7:5		Set to 000b to select VOUT_LINEAR Mode (Five bit two's complement exponent for the MANTISSA delivered as the data bytes for an output voltage related command), set to 001b to select VID Mode (Five bit VID code identifier per) or set to 010b to select Direct Mode (Always set to 00000b).	000	Linear	Linear Mode Format.
			001	VID	VID Mode.
			010	Direct	Direct Mode.

**VIN\_ON (0x35)**

Description: The VIN\_ON command sets the value of the input voltage, in volts, at which the unit should start power conversion.

Bit	Description	Format	Unit
15:0	Sets the VIN ON threshold.	Linear	V

**VIN\_OFF (0x36)**

Description: The VIN\_OFF command sets the value of the input voltage, in volts, at which the unit, once operation has started, should stop power conversion.

Bit	Description	Format	Unit
15:0	Sets the VIN OFF threshold.	Linear	V

**INTERLEAVE (0x37)**

Description: Configures the phase offset with respect to a common SYNC clock. When multiple products share a common DC input supply, spreading of the switching phases between the products can be utilized. This reduces the input capacitance requirements and efficiency losses, since the peak current drawn from the input supply is effectively spread out over the whole switch period. If two or more units have their outputs connected in parallel, interleaving will reduce ripple currents. This requires that the products are synchronized using the SYNC pin.

Bit	Function	Description	Format
11:8	Group ID Number	Value 0-15. Sets an ID number to a group of interleaved rails.	Integer Unsigned
7:4	Number of Rails	Value 0-15. Sets the number of units in the group, including the SYNC OUT product.	Integer Unsigned
3:0	Rail Position	Value 0-15. Sets the interleave order for this unit. The product configured to SYNC OUT shall be assigned to number 0	Integer Unsigned

**IOUT\_CAL\_OFFSET (0x39)**

Description: Sets the current-sense offset.

Bit	Description	Format	Unit
15:0	Sets an offset to IOUT readings. Use to compensate for delayed measurements of current ramp.	Linear	A

**VOUT\_OV\_FAULT\_LIMIT (0x40)**

Description: Output over voltage fault limit.

Bit	Description	Format	Unit
15:0	Output over voltage fault limit.	Vout Mode Unsigned (Exp = -12)	V

**VOUT\_OV\_FAULT\_RESPONSE (0x41)**

Description: Output over voltage fault response.

Bit	Function	Description	Value	Function	Description
7:6	Response	Describes the device interruption operation. 00b - The PMBus device continues operation without interruption. 01b - The PMBus device continues operation for the delay time specified by bits [2:0] and the delay time unit specified for that particular fault. If the fault condition is still present at the end of the delay time, the unit responds as programmed in the Retry Setting (bits [5:3]). 10b - The device shuts down (disables the output) and responds according to the Retry Setting in bits [5:3]. 11b - The device's output is disabled while the fault is present. Operation resumes and the output is enabled when the fault condition no longer exists.	00	Ignore Fault	The PMBus device continues operation without interruption.
			01	Perform Retries while Operating	The PMBus device continues operation for the delay time specified by bits [2:0] and the delay time unit specified for that particular fault. If the fault condition is still present at the end of the delay time, the unit responds as programmed in the Retry Setting (bits [5:3]).
			10	Disable and retry	The device shuts down (disables the output) and responds according to the retry setting in bits [5:3].
			11	Disable, Resume When OK	The device's output is disabled while the fault is present. Operation resumes and the output is enabled when the fault condition no longer exists.

5:3	Retries	The device attempts to restart the number of times set by these bits. 000b means the device does not attempt a restart. 111b means the device attempts restarting continuously.	000	Do Not Retry	A zero value for the Retry Setting means that the unit does not attempt to restart. The output remains disabled until the fault is cleared (Section 10.7).
			001	Retry Once	The PMBus device attempts to restart 1 time. If the device fails to restart, it disables the output and remains off until the fault is cleared as described in Section 10.7. The time between the start of each attempt to restart is set by the value in bits [2:] along with the delay time unit specified for that particular fault.
			010	Retry Twice	The PMBus device attempts to restart 2 times. If the device fails to restart, it disables the output and remains off until the fault is cleared as described in Section 10.7. The time between the start of each attempt to restart is set by the value in bits [2:] along with the delay time unit specified for that particular fault.
			011	Retry 3 times	The PMBus device attempts to restart 3 times. If the device fails to restart, it disables the output and remains off until the fault is cleared as described in Section 10.7. The time between the start of each attempt to restart is set by the value in bits [2:] along with the delay time unit specified for that particular fault.
			100	Retry 4 times	The PMBus device attempts to restart 4 times. If the device fails to restart, it disables the output and remains off until the fault is cleared as described in Section 10.7. The time between the start of each attempt to restart is set by the value in bits [2:] along with the delay time unit specified for that particular fault.

			101	Retry 5 times	The PMBus device attempts to restart 5 times. If the device fails to restart, it disables the output and remains off until the fault is cleared as described in Section 10.7. The time between the start of each attempt to restart is set by the value in bits [2:] along with the delay time unit specified for that particular fault.
			110	Retry 6 times	The PMBus device attempts to restart 6 times. If the device fails to restart, it disables the output and remains off until the fault is cleared as described in Section 10.7. The time between the start of each attempt to restart is set by the value in bits [2:] along with the delay time unit specified for that particular fault.
			111	Retry Continuously	The PMBus device attempts to restart continuously, without limitation, until it is commanded OFF (by the CONTROL pin or OPERATION command or both), bias power is removed, or another fault condition causes the unit to shut down.
2:0	Retry Time and Delay Time	Number of delay time units. Used for either the amount of time the device is to continue operating after a fault is detected or for the amount of time between attempts to restart. The time unit is set in register 0xD2.	0	1	
			1	2	
			2	4	
			3	8	
			4	16	
			5	32	
			6	64	
			7	128	

**VOUT\_OV\_WARN\_LIMIT (0x42)**

Description: Output over voltage warning limit.

Bit	Description	Format	Unit
15:0	Output over voltage warning limit.	Vout Mode Unsigned (Exp = -12)	V

**VOUT\_UV\_WARN\_LIMIT (0x43)**

Description: Output under voltage warning limit.

Bit	Description	Format	Unit
-----	-------------	--------	------

15:0	Output under voltage warning limit.	Vout Mode Unsigned (Exp = -12)	V
------	-------------------------------------	--------------------------------	---

**VOUT\_UV\_FAULT\_LIMIT (0x44)**

Description: Output under voltage fault limit.

Bit	Description	Format	Unit
15:0	Output under voltage fault limit.	Vout Mode Unsigned (Exp = -12)	V

**VOUT\_UV\_FAULT\_RESPONSE (0x45)**

Description: Output under voltage fault response.

Bit	Function	Description	Value	Function	Description
7:6	Response	Describes the device interruption operation. 00b - The PMBus device continues operation without interruption. 01b - The PMBus device continues operation for the delay time specified by bits [2:0] and the delay time unit specified for that particular fault. If the fault condition is still present at the end of the delay time, the unit responds as programmed in the Retry Setting (bits [5:3]). 10b - The device shuts down (disables the output) and responds according to the Retry Setting in bits [5:3]. 11b - The device's output is disabled while the fault is present. Operation resumes and the output is enabled when the fault condition no longer exists.	00	Ignore Fault	The PMBus device continues operation without interruption.
			01	Perform Retries while Operating	The PMBus device continues operation for the delay time specified by bits [2:0] and the delay time unit specified for that particular fault. If the fault condition is still present at the end of the delay time, the unit responds as programmed in the Retry Setting (bits [5:3]).
			10	Disable and retry	The device shuts down (disables the output) and responds according to the retry setting in bits [5:3].
			11	Disable, Resume When OK	The device's output is disabled while the fault is present. Operation resumes and the output is enabled when the fault condition no longer exists.
5:3	Retries		000	Do Not Retry	A zero value for the Retry Setting means that the unit does not attempt to restart. The output remains disabled until the fault is cleared (Section 10.7).

		The device attempts to restart the number of times set by these bits. 000b means the device does not attempt a restart. 111b means the device attempts restarting continuously.	001	Retry Once	The PMBus device attempts to restart 1 time. If the device fails to restart, it disables the output and remains off until the fault is cleared as described in Section 10.7. The time between the start of each attempt to restart is set by the value in bits [2:] along with the delay time unit specified for that particular fault.
			010	Retry Twice	The PMBus device attempts to restart 2 times. If the device fails to restart, it disables the output and remains off until the fault is cleared as described in Section 10.7. The time between the start of each attempt to restart is set by the value in bits [2:] along with the delay time unit specified for that particular fault.
			011	Retry 3 times	The PMBus device attempts to restart 3 times. If the device fails to restart, it disables the output and remains off until the fault is cleared as described in Section 10.7. The time between the start of each attempt to restart is set by the value in bits [2:] along with the delay time unit specified for that particular fault.
			100	Retry 4 times	The PMBus device attempts to restart 4 times. If the device fails to restart, it disables the output and remains off until the fault is cleared as described in Section 10.7. The time between the start of each attempt to restart is set by the value in bits [2:] along with the delay time unit specified for that particular fault.

			101	Retry 5 times	The PMBus device attempts to restart 5 times. If the device fails to restart, it disables the output and remains off until the fault is cleared as described in Section 10.7. The time between the start of each attempt to restart is set by the value in bits [2:] along with the delay time unit specified for that particular fault.
			110	Retry 6 times	The PMBus device attempts to restart 6 times. If the device fails to restart, it disables the output and remains off until the fault is cleared as described in Section 10.7. The time between the start of each attempt to restart is set by the value in bits [2:] along with the delay time unit specified for that particular fault.
			111	Retry Continuously	The PMBus device attempts to restart continuously, without limitation, until it is commanded OFF (by the CONTROL pin or OPERATION command or both), bias power is removed, or another fault condition causes the unit to shut down.
2:0	Retry Time and Delay Time	Number of delay time units. Used for either the amount of time the device is to continue operating after a fault is detected or for the amount of time between attempts to restart. The time unit is set in register 0xD2.	0	1	
			1	2	
			2	4	
			3	8	
			4	16	
			5	32	
			6	64	
			7	128	

**IOUT\_OC\_FAULT\_LIMIT (0x46)**

Description: Output over current limit.

Bit	Description	Format	Unit
15:0	Output over current fault limit.	Linear	A

**IOUT\_OC\_FAULT\_RESPONSE (0x47)**

Description: Output over current fault response.

Bit	Function	Description	Value	Function	Description
-----	----------	-------------	-------	----------	-------------

7:6	Response	For all values of bits [7:6], the device: Sets the corresponding fault bit in the status registers and if the device supports notifying the host, it does so.	00	Ignore Fault	The PMBus device continues to operate indefinitely while maintaining the output current at the value set by IOUT_OC_FAULT_LIMIT without regard to the output voltage (known as constant-current or brickwall limiting).
			01	Conditioned constant current	The PMBus device continues to operate indefinitely while maintaining the output current at the value set by IOUT_OC_FAULT_LIMIT as long as the output voltage remains above the minimum value specified by IOUT_OC_LV_FAULT_LIMIT. If the output voltage is pulled down to less than that value, then the PMBus device shuts down and responds according to the Retry setting in bits [5:3].
			10	Delay w/ Const. Current & Retry	The PMBus device continues to operate, maintaining the output current at the value set by IOUT_OC_FAULT_LIMIT without regard to the output voltage, for the delay time set by bits [2:0] and the delay time units for specified in the IOUT_OC_FAULT_RESPONSE. If the device is still operating in current limiting at the end of the delay time, the device responds as programmed by the Retry Setting in bits [5:3].
			11	Disable, Resume When OK	The device's output is disabled while the fault is present. Operation resumes and the output is enabled when the fault condition no longer exists.
5:3	Retries		000	Do Not Retry	A zero value for the Retry Setting means that the unit does not attempt to restart. The output remains disabled until the fault is cleared (Section 10.7).

		The device attempts to restart the number of times set by these bits. 000b means the device does not attempt a restart. 111b means the device attempts restarting continuously.	001	Retry Once	The PMBus device attempts to restart 1 time. If the device fails to restart, it disables the output and remains off until the fault is cleared as described in Section 10.7. The time between the start of each attempt to restart is set by the value in bits [2:] along with the delay time unit specified for that particular fault.
			010	Retry Twice	The PMBus device attempts to restart 2 times. If the device fails to restart, it disables the output and remains off until the fault is cleared as described in Section 10.7. The time between the start of each attempt to restart is set by the value in bits [2:] along with the delay time unit specified for that particular fault.
			011	Retry 3 times	The PMBus device attempts to restart 3 times. If the device fails to restart, it disables the output and remains off until the fault is cleared as described in Section 10.7. The time between the start of each attempt to restart is set by the value in bits [2:] along with the delay time unit specified for that particular fault.
			100	Retry 4 times	The PMBus device attempts to restart 4 times. If the device fails to restart, it disables the output and remains off until the fault is cleared as described in Section 10.7. The time between the start of each attempt to restart is set by the value in bits [2:] along with the delay time unit specified for that particular fault.

			101	Retry 5 times	The PMBus device attempts to restart 5 times. If the device fails to restart, it disables the output and remains off until the fault is cleared as described in Section 10.7. The time between the start of each attempt to restart is set by the value in bits [2:] along with the delay time unit specified for that particular fault.
			110	Retry 6 times	The PMBus device attempts to restart 6 times. If the device fails to restart, it disables the output and remains off until the fault is cleared as described in Section 10.7. The time between the start of each attempt to restart is set by the value in bits [2:] along with the delay time unit specified for that particular fault.
			111	Retry Continuously	The PMBus device attempts to restart continuously, without limitation, until it is commanded OFF (by the CONTROL pin or OPERATION command or both), bias power is removed, or another fault condition causes the unit to shut down.
2:0	Retry Time and Delay Time	Number of delay time units. Used for either the amount of time the device is to continue operating after a fault is detected or for the amount of time between attempts to restart. The time unit is set in register 0xD2.	0	1	
			1	2	
			2	4	
			3	8	
			4	16	
			5	32	
			6	64	
			7	128	

**IOUT\_OC\_LV\_FAULT\_LIMIT (0x48)**

Description: Set the output over-current low-voltage fault threshold.

Bit	Description	Format	Unit
15:0	Set the output over-current low-voltage fault threshold.	Vout Mode Unsigned (Exp = -12)	V

**IOUT\_OC\_WARN\_LIMIT (0x4A)**

Description: Output over current warning limit.

Bit	Description	Format	Unit
15:0	Output over current warning limit.	Linear	A

**IOUT\_UC\_FAULT\_LIMIT (0x4B)**

Description: Sets the output under-current peak limit.

Bit	Description	Format	Unit
15:0	Sets the IOUT under-current peak fault threshold.	Linear	A

**IOUT\_UC\_FAULT\_RESPONSE (0x4C)**

Description: Configures the output undercurrent fault response. The command format is the same as the PMBus standard responses for voltage and temperature faults except that it sets the undercurrent status bit.

Bit	Function	Description	Value	Function	Description
7:6	Response	Describes the device interruption operation. For all modes set by bits [7:6], the device pulls SALERT low and sets the related fault bit in the status registers.	00	Ignore Fault	The PMBus device continues operation without interruption.
			01	Perform Retries while Operating	The PMBus device continues operation for the delay time specified by bits [2:0] and the delay time unit specified for that particular fault. If the fault condition is still present at the end of the delay time, the unit responds as programmed in the Retry Setting (bits [5:3]).
			10	Disable and Retry	The device shuts down (disables the output) and responds according to the retry setting in bits [5:3].
			11	Disable, Resume When OK	The device's output is disabled while the fault is present. Operation resumes and the output is enabled when the fault condition no longer exists.
5:3	Retry Setting	The device attempts to restart the number of times set by these bits.	000	Do Not Retry	A zero value for the Retry Setting means that the unit does not attempt to restart. The output remains disabled until the fault is cleared.
			001	Retry Once	The PMBus device attempts to restart 1 time. If the device fails to restart, it disables the output and remains off until the fault is cleared. The time between the start of each attempt to restart is set by the value in bits [2:0] along with the delay time unit specified for that particular fault.
			010	Retry Twice	The PMBus device attempts to restart 2 times.
			011	Retry 3 times	The PMBus device attempts to restart 3 times.
			100	Retry 4 times	The PMBus device attempts to restart 4 times.

			101	Retry 5 times	The PMBus device attempts to restart 5 times.
			110	Retry 6 times	The PMBus device attempts to restart 6 times.
			111	Retry Continuously	The PMBus device attempts to restart continuously, without limitation, until output is DISABLED, bias power is removed, or another fault condition causes the output to shut down.
2:0	Retry Time and Delay Time	Number of delay time units. Used for either the amount of time the device (10 ms/unit) is to continue operating after a fault is detected or for the amount of time (8.2 ms/unit) between attempts to restart.	0	0	
			1	1	
			2	2	
			3	3	
			4	4	
			5	5	
			6	6	
			7	7	

**OT\_FAULT\_LIMIT (0x4F)**

Description: Over temperature fault limit.

Bit	Description	Format	Unit
15:0	Over temperature fault limit.	Linear	°C

**OT\_FAULT\_RESPONSE (0x50)**

Description: Over temperature fault response.

Bit	Function	Description	Value	Function	Description
7:6	Response		00	Ignore Fault	The PMBus device continues operation without interruption.
			01	Perform Retries while Operating	The PMBus device continues operation for the delay time specified by bits [2:0] and the delay time unit specified for that particular fault. If the fault condition is still present at the end of the delay time, the unit responds as programmed in the Retry Setting (bits [5:3]).
			10	Disable and retry	The device shuts down (disables the output) and responds according to the retry setting in bits [5:3].
			11	Disable, Resume When OK	The device's output is disabled while the fault is present. Operation resumes and the output is enabled when the fault condition no longer exists.

5:3	Retries		000	Do Not Retry	A zero value for the Retry Setting means that the unit does not attempt to restart. The output remains disabled until the fault is cleared (Section 10.7).
			001	Retry Once	The PMBus device attempts to restart 1 time. If the device fails to restart, it disables the output and remains off until the fault is cleared as described in Section 10.7. The time between the start of each attempt to restart is set by the value in bits [2:] along with the delay time unit specified for that particular fault.
			010	Retry Twice	The PMBus device attempts to restart 2 times. If the device fails to restart, it disables the output and remains off until the fault is cleared as described in Section 10.7. The time between the start of each attempt to restart is set by the value in bits [2:] along with the delay time unit specified for that particular fault.
			011	Retry 3 times	The PMBus device attempts to restart 3 times. If the device fails to restart, it disables the output and remains off until the fault is cleared as described in Section 10.7. The time between the start of each attempt to restart is set by the value in bits [2:] along with the delay time unit specified for that particular fault.
			100	Retry 4 times	The PMBus device attempts to restart 4 times. If the device fails to restart, it disables the output and remains off until the fault is cleared as described in Section 10.7. The time between the start of each attempt to restart is set by the value in bits [2:] along with the delay time unit specified for that particular fault.

			101	Retry 5 times	The PMBus device attempts to restart 5 times. If the device fails to restart, it disables the output and remains off until the fault is cleared as described in Section 10.7. The time between the start of each attempt to restart is set by the value in bits [2:] along with the delay time unit specified for that particular fault.
			110	Retry 6 times	The PMBus device attempts to restart 6 times. If the device fails to restart, it disables the output and remains off until the fault is cleared as described in Section 10.7. The time between the start of each attempt to restart is set by the value in bits [2:] along with the delay time unit specified for that particular fault.
			111	Retry Continuously	The PMBus device attempts to restart continuously, without limitation, until it is commanded OFF (by the CONTROL pin or OPERATION command or both), bias power is removed, or another fault condition causes the unit to shut down.
2:0	Retry Time and Delay Time	Number of delay time units. Used for either the amount of time the device is to continue operating after a fault is detected or for the amount of time between attempts to restart. The time unit is set in register 0xD2.	0	1	
			1	2	
			2	4	
			3	8	
			4	16	
			5	32	
			6	64	
			7	128	

**OT\_WARN\_LIMIT (0x51)**

Description: Over temperature warning limit.

Bit	Description	Format	Unit
15:0	Over temperature warning limit.	Linear	°C

**UT\_WARN\_LIMIT (0x52)**

Description: Under temperature warning limit.

Bit	Description	Format	Unit
15:0	Under temperature warning limit.	Linear	°C

**UT\_FAULT\_LIMIT (0x53)**

Description: Under temperature fault limit.

Bit	Description	Format	Unit
15:0	Under temperature fault limit.	Linear	°C

**UT\_FAULT\_RESPONSE (0x54)**

Description: Under temperature fault response.

Bit	Function	Description	Value	Function	Description
7:6	Response		00	Ignore Fault	The PMBus device continues operation without interruption.
			01	Perform Retries while Operating	The PMBus device continues operation for the delay time specified by bits [2:0] and the delay time unit specified for that particular fault. If the fault condition is still present at the end of the delay time, the unit responds as programmed in the Retry Setting (bits [5:3]).
			10	Disable and retry	The device shuts down (disables the output) and responds according to the retry setting in bits [5:3].
			11	Disable, Resume When OK	The device's output is disabled while the fault is present. Operation resumes and the output is enabled when the fault condition no longer exists.
5:3	Retries		000	Do Not Retry	A zero value for the Retry Setting means that the unit does not attempt to restart. The output remains disabled until the fault is cleared (Section 10.7).
			001	Retry Once	The PMBus device attempts to restart 1 time. If the device fails to restart, it disables the output and remains off until the fault is cleared as described in Section 10.7. The time between the start of each attempt to restart is set by the value in bits [2:] along with the delay time unit specified for that particular fault.

			010	Retry Twice	The PMBus device attempts to restart 2 times. If the device fails to restart, it disables the output and remains off until the fault is cleared as described in Section 10.7. The time between the start of each attempt to restart is set by the value in bits [2:] along with the delay time unit specified for that particular fault.
			011	Retry 3 times	The PMBus device attempts to restart 3 times. If the device fails to restart, it disables the output and remains off until the fault is cleared as described in Section 10.7. The time between the start of each attempt to restart is set by the value in bits [2:] along with the delay time unit specified for that particular fault.
			100	Retry 4 times	The PMBus device attempts to restart 4 times. If the device fails to restart, it disables the output and remains off until the fault is cleared as described in Section 10.7. The time between the start of each attempt to restart is set by the value in bits [2:] along with the delay time unit specified for that particular fault.
			101	Retry 5 times	The PMBus device attempts to restart 5 times. If the device fails to restart, it disables the output and remains off until the fault is cleared as described in Section 10.7. The time between the start of each attempt to restart is set by the value in bits [2:] along with the delay time unit specified for that particular fault.

			110	Retry 6 times	The PMBus device attempts to restart 6 times. If the device fails to restart, it disables the output and remains off until the fault is cleared as described in Section 10.7. The time between the start of each attempt to restart is set by the value in bits [2:] along with the delay time unit specified for that particular fault.
			111	Retry Continuously	The PMBus device attempts to restart continuously, without limitation, until it is commanded OFF (by the CONTROL pin or OPERATION command or both), bias power is removed, or another fault condition causes the unit to shut down.
2:0	Retry Time and Delay Time	Number of delay time units. Used for either the amount of time the device is to continue operating after a fault is detected or for the amount of time between attempts to restart. The time unit is set in register 0xD2.	0	1	
			1	2	
			2	4	
			3	8	
			4	16	
			5	32	
			6	64	
			7	128	

**VIN\_OV\_FAULT\_LIMIT (0x55)**

Description: Input over voltage fault limit.

Bit	Description	Format	Unit
15:0	Input over voltage fault limit.	Linear	V

**VIN\_OV\_FAULT\_RESPONSE (0x56)**

Description: Input over voltage fault response.

Bit	Function	Description	Value	Function	Description
7:6	Response		00	Ignore Fault	The PMBus device continues operation without interruption.
			01	Perform Retries while Operating	The PMBus device continues operation for the delay time specified by bits [2:0] and the delay time unit specified for that particular fault. If the fault condition is still present at the end of the delay time, the unit responds as programmed in the Retry Setting (bits [5:3]).

			10	Disable and retry	The device shuts down (disables the output) and responds according to the retry setting in bits [5:3].
			11	Disable, Resume When OK	The device's output is disabled while the fault is present. Operation resumes and the output is enabled when the fault condition no longer exists.
5:3	Retries		000	Do Not Retry	A zero value for the Retry Setting means that the unit does not attempt to restart. The output remains disabled until the fault is cleared (Section 10.7).
			001	Retry Once	The PMBus device attempts to restart 1 time. If the device fails to restart, it disables the output and remains off until the fault is cleared as described in Section 10.7. The time between the start of each attempt to restart is set by the value in bits [2:] along with the delay time unit specified for that particular fault.
			010	Retry Twice	The PMBus device attempts to restart 2 times. If the device fails to restart, it disables the output and remains off until the fault is cleared as described in Section 10.7. The time between the start of each attempt to restart is set by the value in bits [2:] along with the delay time unit specified for that particular fault.
			011	Retry 3 times	The PMBus device attempts to restart 3 times. If the device fails to restart, it disables the output and remains off until the fault is cleared as described in Section 10.7. The time between the start of each attempt to restart is set by the value in bits [2:] along with the delay time unit specified for that particular fault.

			100	Retry 4 times	The PMBus device attempts to restart 4 times. If the device fails to restart, it disables the output and remains off until the fault is cleared as described in Section 10.7. The time between the start of each attempt to restart is set by the value in bits [2:] along with the delay time unit specified for that particular fault.
			101	Retry 5 times	The PMBus device attempts to restart 5 times. If the device fails to restart, it disables the output and remains off until the fault is cleared as described in Section 10.7. The time between the start of each attempt to restart is set by the value in bits [2:] along with the delay time unit specified for that particular fault.
			110	Retry 6 times	The PMBus device attempts to restart 6 times. If the device fails to restart, it disables the output and remains off until the fault is cleared as described in Section 10.7. The time between the start of each attempt to restart is set by the value in bits [2:] along with the delay time unit specified for that particular fault.
			111	Retry Continuously	The PMBus device attempts to restart continuously, without limitation, until it is commanded OFF (by the CONTROL pin or OPERATION command or both), bias power is removed, or another fault condition causes the unit to shut down.
2:0	Retry Time and Delay Time	Number of delay time units. Used for either the amount of time the device is to continue operating after a fault is detected or for the amount of time between attempts to restart. The time unit is set in register 0xD2.	0	1	
			1	2	
			2	4	
			3	8	
			4	16	
			5	32	
			6	64	
			7	128	

**VIN\_OV\_WARN\_LIMIT (0x57)**

Description: Input over voltage warning limit.

Bit	Description	Format	Unit
15:0	Input over voltage warning limit.	Linear	V

**VIN\_UV\_WARN\_LIMIT (0x58)**

Description: Input under voltage warning limit. This command set also the input voltage threshold for the HRR function (Hybrid Ratio Regulation). The HRR function is enabled with command MFR\_SPECIAL\_OPTIONS (0xE0).

Bit	Description	Format	Unit
15:0	Input under voltage warning limit and/or HRR threshold.	Linear	V

**VIN\_UV\_FAULT\_LIMIT (0x59)**

Description: Input under voltage fault limit.

Bit	Description	Format	Unit
15:0	Input under voltage fault limit.	Linear	V

**VIN\_UV\_FAULT\_RESPONSE (0x5A)**

Description: Input under voltage fault response.

Bit	Function	Description	Value	Function	Description
7:6	Response		00	Ignore Fault	The PMBus device continues operation without interruption.
			01	Perform Retries while Operating	The PMBus device continues operation for the delay time specified by bits [2:0] and the delay time unit specified for that particular fault. If the fault condition is still present at the end of the delay time, the unit responds as programmed in the Retry Setting (bits [5:3]).
			10	Disable and retry	The device shuts down (disables the output) and responds according to the retry setting in bits [5:3].
			11	Disable, Resume When OK	The device's output is disabled while the fault is present. Operation resumes and the output is enabled when the fault condition no longer exists.
5:3	Retries		000	Do Not Retry	A zero value for the Retry Setting means that the unit does not attempt to restart. The output remains disabled until the fault is cleared (Section 10.7).

			001	Retry Once	The PMBus device attempts to restart 1 time. If the device fails to restart, it disables the output and remains off until the fault is cleared as described in Section 10.7. The time between the start of each attempt to restart is set by the value in bits [2:] along with the delay time unit specified for that particular fault.
			010	Retry Twice	The PMBus device attempts to restart 2 times. If the device fails to restart, it disables the output and remains off until the fault is cleared as described in Section 10.7. The time between the start of each attempt to restart is set by the value in bits [2:] along with the delay time unit specified for that particular fault.
			011	Retry 3 times	The PMBus device attempts to restart 3 times. If the device fails to restart, it disables the output and remains off until the fault is cleared as described in Section 10.7. The time between the start of each attempt to restart is set by the value in bits [2:] along with the delay time unit specified for that particular fault.
			100	Retry 4 times	The PMBus device attempts to restart 4 times. If the device fails to restart, it disables the output and remains off until the fault is cleared as described in Section 10.7. The time between the start of each attempt to restart is set by the value in bits [2:] along with the delay time unit specified for that particular fault.

			101	Retry 5 times	The PMBus device attempts to restart 5 times. If the device fails to restart, it disables the output and remains off until the fault is cleared as described in Section 10.7. The time between the start of each attempt to restart is set by the value in bits [2:] along with the delay time unit specified for that particular fault.
			110	Retry 6 times	The PMBus device attempts to restart 6 times. If the device fails to restart, it disables the output and remains off until the fault is cleared as described in Section 10.7. The time between the start of each attempt to restart is set by the value in bits [2:] along with the delay time unit specified for that particular fault.
			111	Retry Continuously	The PMBus device attempts to restart continuously, without limitation, until it is commanded OFF (by the CONTROL pin or OPERATION command or both), bias power is removed, or another fault condition causes the unit to shut down.
2:0	Retry Time and Delay Time	Number of delay time units. Used for either the amount of time the device is to continue operating after a fault is detected or for the amount of time between attempts to restart. The time unit is set in register 0xD2.	0	1	
			1	2	
			2	4	
			3	8	
			4	16	
			5	32	
			6	64	
			7	128	

**POWER\_GOOD\_ON (0x5E)**

Description: Sets the output voltage threshold for asserting PG (Power Good).

Bit	Description	Format	Unit
15:0	The POWER_GOOD_ON command sets the output voltage at which an optional POWER_GOOD signal should be asserted.	Vout Mode Unsigned (Exp = -12)	V

**POWER\_GOOD\_OFF (0x5F)**

Description: Sets the output voltage threshold for deasserting PG (Power Good).

Bit	Description	Format	Unit
-----	-------------	--------	------

15:0	The POWER_GOOD_OFF command sets the output voltage at which an optional POWER_GOOD signal should be deasserted.	Vout Mode Unsigned (Exp = -12)	V
------	---	--------------------------------	---

**TON\_DELAY (0x60)**

Description: Sets the turn-on delay time

Bit	Description	Format	Unit
15:0	Sets the delay time from ENABLE to start of VOUT rise.	Linear	ms

**TON\_RISE (0x61)**

Description: Sets the turn-on transition time.

Bit	Description	Format	Unit
15:0	Sets the rise time of VOUT after ENABLE and TON_DELAY.	Linear	ms

**TON\_MAX\_FAULT\_LIMIT (0x62)**

Description: Sets an upper limit, in milliseconds, on how long the unit can attempt to power up the output without reaching the output undervoltage fault limit.

Bit	Description	Format	Unit
15:0	A value of 0 milliseconds means that there is no limit and that the unit can attempt to bring up the output voltage indefinitely.	Linear	ms

**TON\_MAX\_FAULT\_RESPONSE (0x63)**

Description: Only some of the response types are supported.

Bit	Function	Description	Value	Function	Description
7:6	Response		00	Ignore Fault	The PMBus device continues operation without interruption.
			01	Perform Retries while Operating	The PMBus device continues operation for the delay time specified by bits [2:0] and the delay time unit specified for that particular fault. If the fault condition is still present at the end of the delay time, the unit responds as programmed in the Retry Setting (bits [5:3]).
			10	Disable and retry	The device shuts down (disables the output) and responds according to the retry setting in bits [5:3].
			11	Disable, Resume When OK	The device's output is disabled while the fault is present. Operation resumes and the output is enabled when the fault condition no longer exists.

5:3	Retries		000	Do Not Retry	A zero value for the Retry Setting means that the unit does not attempt to restart. The output remains disabled until the fault is cleared (Section 10.7).
			001	Retry Once	The PMBus device attempts to restart 1 time. If the device fails to restart, it disables the output and remains off until the fault is cleared as described in Section 10.7. The time between the start of each attempt to restart is set by the value in bits [2:] along with the delay time unit specified for that particular fault.
			010	Retry Twice	The PMBus device attempts to restart 2 times. If the device fails to restart, it disables the output and remains off until the fault is cleared as described in Section 10.7. The time between the start of each attempt to restart is set by the value in bits [2:] along with the delay time unit specified for that particular fault.
			011	Retry 3 times	The PMBus device attempts to restart 3 times. If the device fails to restart, it disables the output and remains off until the fault is cleared as described in Section 10.7. The time between the start of each attempt to restart is set by the value in bits [2:] along with the delay time unit specified for that particular fault.
			100	Retry 4 times	The PMBus device attempts to restart 4 times. If the device fails to restart, it disables the output and remains off until the fault is cleared as described in Section 10.7. The time between the start of each attempt to restart is set by the value in bits [2:] along with the delay time unit specified for that particular fault.

			101	Retry 5 times	The PMBus device attempts to restart 5 times. If the device fails to restart, it disables the output and remains off until the fault is cleared as described in Section 10.7. The time between the start of each attempt to restart is set by the value in bits [2:] along with the delay time unit specified for that particular fault.
			110	Retry 6 times	The PMBus device attempts to restart 6 times. If the device fails to restart, it disables the output and remains off until the fault is cleared as described in Section 10.7. The time between the start of each attempt to restart is set by the value in bits [2:] along with the delay time unit specified for that particular fault.
			111	Retry Continuously	The PMBus device attempts to restart continuously, without limitation, until it is commanded OFF (by the CONTROL pin or OPERATION command or both), bias power is removed, or another fault condition causes the unit to shut down.
2:0	Retry Time and Delay Time	Number of delay time units. Used for either the amount of time the device is to continue operating after a fault is detected or for the amount of time between attempts to restart. The time unit is set in register 0xD2. TON_MAX_FAULT_RESPONSE time unit is referenced to VOUT FAULT time unit.	0	1	
			1	2	
			2	4	
			3	8	
			4	16	
			5	32	
			6	64	
			7	128	

**TOFF\_DELAY (0x64)**

Description: Sets the turn-off delay.

Bit	Description	Format	Unit
15:0	Sets the delay time from DISABLE to start of VOUT fall.	Linear	ms

**TOFF\_FALL (0x65)**

Description: Sets the turn-off transition time.

Bit	Description	Format	Unit
15:0	Sets the fall time for VOUT after DISABLE and TOFF_DELAY.	Linear	ms

**TOFF\_MAX\_WARN\_LIMIT (0x66)**

Description: Sets an upper limit, in milliseconds, on how long the unit can attempt to power down the output without reaching 12.5% of the output voltage programmed at the time the unit is turned off.

Bit	Description	Format	Unit
15:0		Linear	ms

**POUT\_OP\_WARN\_LIMIT (0x6A)**

Description: Sets the output over-power warning limit.

Bit	Description	Format	Unit
15:0	Sets the output over-power warning threshold.	Linear	W

**PIN\_OP\_WARN\_LIMIT (0x6B)**

Description: Sets the input over-power warning limit.

Bit	Description	Format	Unit
15:0	Sets the input over-power warning threshold.	Linear	W

**STATUS\_BYTE (0x78)**

Description: Returns a brief fault/warning status byte.

Bit	Function	Description	Value	Description
7	Busy	This bit is asserted if the unit is busy	0	No fault
			1	Fault
6	Off	This bit is asserted if the unit is not providing power to the output, regardless of the reason, including simply not being enabled.	0	No fault
			1	Fault
5	Vout Overvoltage Fault	An output overvoltage fault has occurred.	0	No fault
			1	Fault
4	Iout Overcurrent Fault	An output overcurrent fault has occurred.	0	No fault
			1	Fault
3	Vin Undervoltage Fault	An input undervoltage fault has occurred.	0	No fault
			1	Fault
2	Temperature	A temperature fault or warning has occurred.	0	No fault
			1	Fault
1	Communication/Logic	A communications, memory or logic fault has occurred.	0	No fault
			1	Fault
0	None of the Above	A fault or warning not listed in bits [7:1] has occurred.	0	No fault
			1	Fault

**STATUS\_WORD (0x79)**

Description: Returns an extended fault/warning status byte.

Bit	Function	Description	Value	Description
15	Vout	An output voltage fault or warning has occurred.	0	No fault
			1	Fault
14	Iout/Pout	An output current or output power fault or warning has occurred.	0	No Fault.
			1	Fault.
13	Input	An input voltage, input current, or input power fault or warning has occurred.	0	No Fault.
			1	Fault.
12	Mfr Specific	A manufacturer specific fault or warning has occurred.	0	No fault.
			1	Fault.
11	Power-Good	The Power-Good signal, if present, is negated.	0	No Fault.

9	Other	A bit in Status-Other is set.	1	Fault.
			0	No fault
6	Off	This bit is asserted if the unit is not providing power to the output, regardless of the reason, including simply not being enabled.	1	Fault
			0	No fault
5	Vout Overvoltage Fault	An output overvoltage fault has occurred.	1	Fault.
			0	No Fault.
4	Iout Overcurrent Fault	An output overcurrent fault has occurred.	1	Fault.
			0	No Fault.
3	Vin Undervoltage Fault	An input undervoltage fault has occurred.	1	Fault.
			0	No Fault.
2	Temperature	A temperature fault or warning has occurred.	1	Fault.
			0	No Fault.
1	Communication/Logic	A communications, memory or logic fault has occurred.	1	Fault.
			0	No fault.
0	None of the Above	A fault or warning not listed in bits [7:1] has occurred.	1	Fault.
			0	No fault.

**STATUS\_VOUT (0x7A)**

Description: Returns Vout-related fault/warning status bits.

Bit	Function	Description	Value	Description
7	Vout Overvoltage Fault	Vout Overvoltage Fault.	0	No Fault.
			1	Fault.
6	Vout Overvoltage Warning	Vout Overvoltage Warning.	0	No Warning.
			1	Warning.
5	Vout Undervoltage Warning	Vout Undervoltage Warning.	0	No Warning.
			1	Warning.
4	Vout Undervoltage Fault	Vout Undervoltage Fault.	0	No Fault.
			1	Fault.
3	Vout Max Warning	Vout Max Warning (An attempt has been made to set the output voltage to value higher than allowed by the Vout Max command (Section 13.5)).	0	No Warning.
			1	Warning.
2	Ton Max Fault	Ton-Max Fault.	0	No Fault
			1	Fault.
1	Toff Max Warning	Toff Max Warning.	0	No Warning.
			1	Warning.

**STATUS\_IOUT (0x7B)**

Description: Returns Iout-related fault/warning status bits.

Bit	Function	Description	Value	Description
7	Iout Overcurrent Fault	Iout Overcurrent Fault.	0	No Fault.
			1	Fault.
6	Iout Overcurrent And Low Voltage Fault	Iout Overcurrent and low voltage fault.	0	No Fault.
			1	Fault.
5	Iout Over Current Warning	Iout Overcurrent Warning.	0	No Warning.
			1	Warning.
4	Iout Undercurrent Fault	Iout Undercurrent Fault.	0	No Fault.
			1	Fault.

**STATUS\_INPUT (0x7C)**

Description: Returns VIN/IIN-related fault/warning status bits.

Bit	Function	Description	Value	Description
7	Vin Overvoltage Fault	Vin Overvoltage Fault.	0	No Fault.
			1	Fault.
6	Vin Overvoltage Warning	VIN Overvoltage Warning.	0	No Warning.
			1	Warning.
5	Vin Undervoltage Warning	Vin Undervoltage Warning.	0	No Warning.
			1	Warning.
4	Vin Undervoltage Fault	Vin Undervoltage Fault.	0	No Fault.
			1	Fault.
3	Insufficient Vin	Asserted when either the input voltage has never exceeded the input turn-on threshold Vin-On, or if the unit did start, the input voltage decreased below the turn-off threshold.	0	No Insufficient VIN encountered yet.
			1	Insufficient Unit is off.

**STATUS\_TEMPERATURE (0x7D)**

Description: Returns the temperature-related fault/warning status bits

Bit	Function	Description	Value	Description
7	Overtemperature Fault	Overtemperature Fault.	0	No Fault.
			1	Fault.
6	Overtemperature Warning	Overtemperature Warning.	0	No Warning.
			1	Warning.
5	Undertemperature Warning	Undertemperature Warning.	0	No Warning.
			1	Warning.
4	Undertemperature Fault	Undertemperature Fault.	0	No Fault.
			1	Fault.

**STATUS\_CML (0x7E)**

Description: Returns Communication/Logic/Memory-related fault/warning status bits.

Bit	Function	Description	Value	Description
7	Invalid Or Unsupported Command Received	Invalid Or Unsupported Command Received.	0	No Invalid Command Received.
			1	Invalid Command Received.
6	Invalid Or Unsupported Data Received	Invalid Or Unsupported Data Received.	0	No Invalid Data Received.
			1	Invalid Data Received.
5	Packet Error Check Failed	Packet Error Check Failed.	0	No Failure.
			1	Failure.
4	Memory Fault Detected	Memory Fault Detected.	0	No Fault.
			1	Fault.
3	Processor Fault Detected	Processor fault detected.	0	No Fault.
			1	Fault.
1	Other Communication Fault	A communication fault other than the ones listed in this table has occurred.	0	No Fault.
			1	Fault.
0	Memory Or Logic Fault	Other Memory Or Logic Fault has occurred.	0	No Fault.
			1	Fault.

**STATUS\_OTHER (0x7F)**

Description: Returns a brief other fault/warning status bits.

Bit	Description	Value	Description
0	The device was the first to assert SMBALERT.		

**STATUS\_MFR\_SPECIFIC (0x80)**

Description: Returns manufacturer specific status information.

Bit	Function	Description	Value	Description
7	Sync Fault	Sync fault.	0	No fault.
			1	Fault.
6	Iout Average Overcurrent Fault	Iout average overcurrent fault.	0	No fault.
			1	Fault.
5	Iout Fast Overcurrent Fault	Iout fast overcurrent fault.	0	No fault.
			1	Fault.
4	Short Circuit Protection Fault	Short circuit protection fault.	0	No fault.
			1	Fault.
3	Overtemperature2 Fault	Overtemperature2 fault.	0	No fault.
			1	Fault.
2	Auxiliary Voltage Fault	Auxiliary voltage fault.	0	No fault.
			1	Fault.
1	Startup Over Current Fault	Startup over current fault.	0	No fault.
			1	Fault.
0	Overtemperature2 Warn	Overtemperature2 warn.	0	No fault.
			1	Fault.

**READ\_VIN (0x88)**

Description: Returns the measured input voltage.

Bit	Description	Format	Unit
15:0	Returns the input voltage reading.	Linear	V

**READ\_VOUT (0x8B)**

Description: Returns the measured output voltage.

Bit	Description	Format	Unit
15:0	Returns the measured output voltage.	Vout Mode Unsigned (Exp = -12)	V

**READ\_IOUT (0x8C)**

Description: Returns the measured output current.

Bit	Description	Format	Unit
15:0	Returns the measured output current.	Linear	A

**READ\_TEMPERATURE\_1 (0x8D)**

Description: Reads temperature from the temperature sensor chosen in MFR\_SELECT\_TEMPERATURE\_SENSOR (0xDC) command.

Bit	Description	Format	Unit
15:0		Linear	°C

**READ\_TEMPERATURE\_2 (0x8E)**

Description: Reads temperature from the temperature sensor chosen in MFR\_SELECT\_TEMPERATURE\_SENSOR (0xDC) command.

Bit	Description	Format	Unit
15:0		Linear	°C

**READ\_DUTY\_CYCLE (0x94)**

Description: Returns the actual duty cycle in percent.

Bit	Description	Format	Unit
15:0	Returns the actual duty cycle in percent.	Linear	%

**READ\_FREQUENCY (0x95)**

Description: Returns the actual switching frequency.

Bit	Description	Format	Unit
15:0	Returns the actual switching frequency.	Linear	kHz

**PMBUS\_REVISION (0x98)**

Description: Returns the PMBus revision number for this device.

Bit	Function	Description	Value	Function	Description
7:4	Part I Revision	Part I Revision.	0x0	1.0	Part I Revision 1.0.
			0x1	1.1	Part I Revision 1.1.
			0x2	1.2	Part I Revision 1.2.
			0x3	1.3	Part I Revision 1.3.
3:0	Part II Revision	Part II Revision.	0x0	1.0	Part II Revision 1.0.
			0x1	1.1	Part II Revision 1.1.
			0x2	1.2	Part II Revision 1.2.
			0x3	1.3	Part II Revision 1.3.

**MFR\_ID (0x99)**

Description: Sets the Manufacturers ID

Bit	Description	Format
95:0	Maximum of 12 characters.	ASCII

**MFR\_MODEL (0x9A)**

Description: Sets the MFR MODEL string.

Bit	Description	Format
159:0	Maximum of 20 characters.	ASCII

**MFR\_REVISION (0x9B)**

Description: Sets the MFR revision string.

Bit	Description	Format
95:0	Maximum of 12 characters.	ASCII

**MFR\_LOCATION (0x9C)**

Description: Sets the MFR location string.

Bit	Description	Format
95:0	Maximum of 12 characters.	ASCII

**MFR\_DATE (0x9D)**

Description: This command returns the date the regulator was manufactured.

Bit	Description	Format
95:0	Maximum of 12 characters.	ASCII

**MFR\_SERIAL (0x9E)**

Description: This command returns a string of 13 characters and numbers that provides a unique identification of the regulator.

Bit	Description	Format
159:0	Maximum of 20 characters.	ASCII

**USER\_DATA\_00 (0xB0)**

Description: This command is available as generic read/write storage for customers.

Bit	Description	Format
127:0	16 bytes of user data.	Byte Array

**FW\_CONFIG\_REGULATION (0xC5)**

Description: FW CONFIG REGULATION parameter

Bit	Description	Value	Function	Description
0	Enable diode emulation at startup	0	Disabled	
		1	Enabled	

**FW\_CONFIG\_FAULTS (0xC8)**

Description: FW CONFIG FAULTS parameter

Bit	Function	Description	Value	Function	Description
7:6	Vout Delay Unit	Vout_Delay_Unit Time unit for retry responses. 0: 1ms, 1: 4ms, 2: 16ms, 3: 256ms	00	1ms/unit	Vout Delay Unit Time unit for retry responses
			01	4ms/unit	Vout Delay Unit Time unit for retry responses
			10	16ms/unit	Vout Delay Unit Time unit for retry responses
			11	256ms/unit	Vout Delay Unit Time unit for retry responses
5:4	Vin Delay Unit	Vin_Delay_Unit Time unit for retry responses. 0: 1ms, 1: 4ms, 2: 16ms, 3: 256ms	00	1ms/unit	Vin Delay Unit Time unit for retry responses
			01	4ms/unit	Vin Delay Unit Time unit for retry responses
			10	16ms/unit	Vin Delay Unit Time unit for retry responses
			11	256ms/unit	Vin Delay Unit Time unit for retry responses
3:2	IOUT Delay Unit	IOOUT_Delay_Unit Time unit for retry responses. 0: 1ms, 1: 4ms, 2: 16ms, 3: 256ms	00	1ms/unit	IOOUT Delay Unit Time unit for retry responses
			01	4ms/unit	IOOUT Delay Unit Time unit for retry responses
			10	16ms/unit	IOOUT Delay Unit Time unit for retry responses
			11	256ms/unit	IOOUT Delay Unit Time unit for retry responses

1:0	Temperature Delay Unit	Temperature_Delay_Unit Time unit for retry responses. 0: 1ms, 1: 4ms, 2: 16ms, 3: 256ms	00	1ms/unit	Temperature Delay Unit Time unit for retry responses
			01	4ms/unit	Temperature Delay Unit Time unit for retry responses
			10	16ms/unit	Temperature Delay Unit Time unit for retry responses
			11	256ms/unit	Temperature Delay Unit Time unit for retry responses

**FW\_CONFIG\_PMBUS (0xC9)**

Description: This command contains various configurable settings related to PMBus address and digital pins.

Bit	Function	Description	Format
31:24	PMBus Base Addr	Base Address for PMBus offset to start from	Integer Unsigned
23:17	PMBus Addr Offset	PMBUS Address offset when resistor offset Not enabled	Integer Unsigned

Bit	Function	Description	Value	Function	Description
39	Power good polarity	Power good polarity (1:active high; 0: active low).	0	Active low	
			1	Active high	
32	Control pin polarity	Control pin polarity (1:active high; 0: active low).	0	Active low	
			1	Active high	
16	PMBus Addr Offset Resistor Enable	PMBus_addr_offset_enable Enable PMBUS Address Offset via resistor	0	Disabled	
			1	Enabled	

**MFR\_IOUT\_OC\_FAST\_FAULT\_RESPONSE (0xCA)**

Description: Output over current fault response.

Bit	Function	Description	Value	Function	Description
7:6	Response	For all values of bits [7:6],the device: Sets the corresponding fault bit in the status registers and If the device supports notifying the host, it does so.	00	Ignore Fault	The PMBus device continues to operate indefinitely while maintaining the output current at the value set by IOUT_OC_FAULT_LIMIT without regard to the output voltage (known as constant-current or brickwall limiting).
			11	Shutdown and Retry	The PMBus device continues to operate, maintaining the output current at the value set by IOUT_OC_FAST_FAULT_LIMIT without regard to the output voltage, for the delay time set by bits [2:0] and the delay time units for specified in the IOUT_OC_FAST_FAULT_RESPONSE. If the device is still operating in current limiting at the end of the delay time, the device responds as programmed by the Retry Setting in bits [5:3].

5:3	Retries	The device attempts to restart the number of times set by these bits. 000b means the device does not attempt a restart. 111b means the device attempts restarting continuously.	000	Do Not Retry	A zero value for the Retry Setting means that the unit does not attempt to restart. The output remains disabled until the fault is cleared (Section 10.7).
			001	Retry Once	The PMBus device attempts to restart 1 time. If the device fails to restart, it disables the output and remains off until the fault is cleared as described in Section 10.7. The time between the start of each attempt to restart is set by the value in bits [2:] along with the delay time unit specified for that particular fault.
			010	Retry Twice	The PMBus device attempts to restart 2 times. If the device fails to restart, it disables the output and remains off until the fault is cleared as described in Section 10.7. The time between the start of each attempt to restart is set by the value in bits [2:] along with the delay time unit specified for that particular fault.
			011	Retry 3 times	The PMBus device attempts to restart 3 times. If the device fails to restart, it disables the output and remains off until the fault is cleared as described in Section 10.7. The time between the start of each attempt to restart is set by the value in bits [2:] along with the delay time unit specified for that particular fault.
			100	Retry 4 times	The PMBus device attempts to restart 4 times. If the device fails to restart, it disables the output and remains off until the fault is cleared as described in Section 10.7. The time between the start of each attempt to restart is set by the value in bits [2:] along with the delay time unit specified for that particular fault.

			101	Retry 5 times	The PMBus device attempts to restart 5 times. If the device fails to restart, it disables the output and remains off until the fault is cleared as described in Section 10.7. The time between the start of each attempt to restart is set by the value in bits [2:] along with the delay time unit specified for that particular fault.
			110	Retry 6 times	The PMBus device attempts to restart 6 times. If the device fails to restart, it disables the output and remains off until the fault is cleared as described in Section 10.7. The time between the start of each attempt to restart is set by the value in bits [2:] along with the delay time unit specified for that particular fault.
			111	Retry Continuously	The PMBus device attempts to restart continuously, without limitation, until it is commanded OFF (by the CONTROL pin or OPERATION command or both), bias power is removed, or another fault condition causes the unit to shut down.
2:0	Retry Time and Delay Time	Number of delay time units. Used for either the amount of time the device is to continue operating after a fault is detected or for the amount of time between attempts to restart. The time unit is set in register 0xC8.	0	1	
			1	2	
			2	4	
			3	8	
			4	16	
			5	32	
			6	64	
			7	128	

**MFR\_IOUT\_AVG\_OC\_FAULT\_LIMIT (0xD0)**

Description: Average output over current limit.

Bit	Description	Format	Unit
15:0	Average output over current fault limit.	Linear	A

**MFR\_IOUT\_OC\_FAST\_FAULT\_LIMIT (0xD1)**

Description: The MFR\_IOUT\_OC\_FAST\_FAULT\_LIMIT command sets or retrieves IOUT fast overcurrent fault threshold, in Amperes.

Bit	Description	Format	Unit
15:0	Sets IOUT fast over-current fault threshold.	Integer Unsigned	A

**MFR\_IOUT\_AVG\_COEFF (0xD2)**

Description: Coefficient for controlling the averaging strength for the averaged Iout current limit.

Bit	Description	Format
5:0	Coefficient for controlling the averaging strength for the averaged Iout current limit. Value 0-63. Setting the coefficient to 0 will disable the averaging and the average current limit behaviour.	Integer Unsigned

**MFR\_READ\_EVENT (0xD7)**

Description: Retrieves historical information from the snapshot function stored in OTP memory. The MFR\_EVENT\_INDEX command is used to retrieve the number of available snapshots and to set which snapshot should be available to read through this command.

Bit	Function	Description	Format	Unit
207:176	Ticks Low Bytes	The Lowest bytes of the event ticks.	Fixed Point Unsigned	
175:168	Ticks High Byte	The highest byte of the event ticks.	Byte Array	
95:80	Read Duty Cycle	Returns the actual duty cycle in percent.	Fixed Point Signed	%
79:64	Read Temperature 1		Integer Signed	°C
63:48	Read Iout	Returns the measured output current.	Fixed Point Signed	A
47:32	Read Vout	Returns the measured output voltage.	Fixed Point Signed	V
31:16	Read Vin	Returns the input voltage reading.	Fixed Point Signed	V
15:0	Event ID	Event id < 2^16.	Integer Unsigned	

Bit	Function	Description	Value	Function	Description
167:164	Old State	The old state bit field contains the state of the module around 4ms before the error occurred. This is generally of higher interest than the error state.	0000	Idle	Idle.
			0001	Ton Delay	Ton Delay.
			0010	Ramp Up	Ramp Up.
			0011	Regulating	Regulating.
			0100	Toff Delay	Toff Delay.
			0101	Ramp Down	Ramp Down.
			0110	Fault	Fault.
163:160	Error State	The error state bit field contains the state of the module when the error is detected, this will normally have the value FAULT unless a firmware fault occurs or the response setting is set to ignore fault.	0000	Idle	Idle.
			0001	Ton Delay	Ton Delay.
			0010	Ramp Up	Ramp Up.
			0011	Regulating	Regulating.
			0100	Toff Delay	Toff Delay.
			0101	Ramp Down	Ramp Down.
			0110	Fault	Fault.
159	Sync Fault	Sync fault.	0		No fault.
			1		Fault.
158		Iout average overcurrent fault.	0		No fault.

	Iout Average Overcurrent Fault		1		Fault.
157	Iout Fast Overcurrent Fault	Iout fast overcurrent fault.	0		No fault.
			1		Fault.
156	Short Circuit Protection Fault	Short circuit protection fault.	0		No fault.
			1		Fault.
155	Over Temperature 2 Protection Fault	Over temperature 2 protection fault.	0		No fault.
			1		Fault.
154	Auxiliary Voltage Protection Fault	Auxiliary voltage protection fault.	0		No fault.
			1		Fault.
153	Startup Over Current Protection Fault	Startup over current protection fault.	0		No fault.
			1		Fault.
152	Over Temperature 2 Protection Warning	Over temperature 2 protection warning.	0		No fault.
			1		Fault.
151	Invalid Or Unsupported Command Received	Invalid Or Unsupported Command Received.	0		No Invalid Command Received.
			1		Invalid Command Received.
150	Invalid Or Unsupported Data Received	Invalid Or Unsupported Data Received.	0		No Invalid Data Received.
			1		Invalid Data Received.
149	Packet Error Check Failed	Packet Error Check Failed.	0		No Failure.
			1		Failure.
148	Memory Fault Detected	Memory Fault Detected.	0		No Fault.
			1		Fault.
145	Other Communication Fault	A communication fault other than the ones listed in this table has occurred.	0		No Fault.
			1		Fault.
144	Memory Or Logic Fault	Other Memory Or Logic Fault has occurred.	0		No Fault.
			1		Fault.
143	Overtemperature Fault	Overtemperature Fault.	0		No Fault.
			1		Fault.
142	Overtemperature Warning	Overtemperature Warning.	0		No Warning.
			1		Warning.
141	Undertemperature Warning	Undertemperature Warning.	0		No Warning.
			1		Warning.
140	Undertemperature Fault	Undertemperature Fault.	0		No Fault.
			1		Fault.
135	Vin Overvoltage Fault	Vin Overvoltage Fault.	0		No Fault.
			1		Fault.
134		VIN Overvoltage Warning.	0		No Warning.

	Vin Overvoltage Warning		1		Warning.
133	Vin Undervoltage Warning	Vin Undervoltage Warning.	0		No Warning.
			1		Warning.
132	Vin Undervoltage Fault	Vin Undervoltage Fault.	0		No Fault.
			1		Fault.
131	Insufficient Vin	Asserted when either the input voltage has never exceeded the input turn-on threshold Vin-On, or if the unit did start, the input voltage decreased below the turn-off threshold.	0		No Insufficient VIN encountered yet.
			1		Insufficient Unit is off.
127	Iout Overcurrent Fault	Iout Overcurrent Fault.	0		No Fault.
			1		Fault.
126	Iout Overcurrent And Low Voltage Fault	Iout Overcurrent and low voltage fault.	0		No Fault.
			1		Fault.
125	Iout Over Current Warning	Iout Overcurrent Warning.	0		No Warning.
			1		Warning.
124	Iout Undercurrent Fault	Iout Undercurrent Fault.	0		No Fault.
			1		Fault.
119	Vout Overvoltage Fault	Vout Overvoltage Fault.	0		No Fault.
			1		Fault.
118	Vout Overvoltage Warning	Vout Overvoltage Warning.	0		No Warning.
			1		Warning.
117	Vout Undervoltage Warning	Vout Undervoltage Warning.	0		No Warning.
			1		Warning.
116	Vout Undervoltage Fault	Vout Undervoltage Fault.	0		No Fault.
			1		Fault.
115	Vout Max Warning	Vout Max Warning (An attempt has been made to set the output voltage to value higher than allowed by the Vout Max command (Section 13.5)).	0		No Warning.
			1		Warning.
114	Ton Max Fault	Ton-Max Fault.	0		No Fault
			1		Fault.
113	Toff Max Warning	Toff Max Warning.	0		No Warning.
			1		Warning.
111	Vout	An output voltage fault or warning has occurred.	0		No fault
			1		Fault
110	Iout/Pout	An output current or output power fault or warning has occurred.	0		No Fault.
			1		Fault.
109	Input		0		No Fault.

		An input voltage, input current, or input power fault or warning has occurred.	1		Fault.
108	Mfr Specific	A manufacturer specific fault or warning has occurred.	0		No Fault.
			1		Fault.
107	Power-Good	The Power-Good signal, if present, is negated.	0		No Fault.
			1		Fault.
102	Off	This bit is asserted if the unit is not providing power to the output, regardless of the reason, including simply not being enabled.	0		No fault
			1		Fault
101	Vout Overvoltage Fault	An output overvoltage fault has occurred.	0		No Fault.
			1		Fault.
100	Iout Overcurrent Fault	An output overcurrent fault has occurred.	0		No Fault.
			1		Fault.
99	Vin Undervoltage Fault	An input undervoltage fault has occurred.	0		No Fault.
			1		Fault.
98	Temperature	A temperature fault or warning has occurred.	0		No Fault.
			1		Fault.
97	Communication/Logic	A communications, memory or logic fault has occurred.	0		No fault.
			1		Fault.
96	None of the Above	A fault or warning not listed in bits [7:1] has occurred.	0		No fault.
			1		Fault.

**MFR\_READ\_VAUX (0xDA)**

Description: Returns the measured auxiliary input voltage.

Bit	Description	Format	Unit
15:0	Returns the auxiliary input voltage reading.	Linear	V

**MFR\_EVENT\_INDEX (0xDB)**

Description: When reading this command returns the number of events logged. When writing to this command it controls which event can be retrieved via the MFR\_READ\_EVENT command. Valid values when writing are the integers in the interval [0; count - 1].

Bit	Description	Format
15:0	Mfr. event index.	Integer Unsigned

**MFR\_SELECT\_TEMPERATURE\_SENSOR (0xDC)**

Description: Select which temperature sensor, internal one or external remote temperature sensor, is used.

Bit	Function	Description	Value	Function	Description
4:3	Fault Source Select	Select which temperature sensor, internal one or external remote temperature sensor, is used.	00	Temp A	Temp A temperature sensor selected.
			01	Temp B	Temp B temperature sensor selected.
			10	Temp I	Temp I temperature sensor selected.
2:0		READ_TEMPERATURE_1 READ_TEMPERATURE_2 Source Select.	000	TempA TempB	TempA (External Temperature sensor A) TempB (External Temperature sensor B).

READ_TEMPERATURE_1 READ_TEMPERATURE_2 Source Select	001	TempA Templ	TempA (External Temperature sensor A) Templ (Internal Temperature sensor).
	010	TempB TempA	TempB (External Temperature sensor B) TempA (External Temperature sensor A).
	011	TempB Templ	TempB (External Temperature sensor B) Templ (Internal Temperature sensor).
	100	Templ TempA	Templ (Internal Temperature sensor) TempA (External Temperature sensor A).
	101	Templ TempB	Templ (Internal Temperature sensor) TempB (External Temperature sensor B).

**MFR\_FLEX\_FIRMWARE\_CMD (0xE0)**

Description: Mfr. firmware command.

Bit	Description	Format
63:0	Mfr. firmware command.	Byte Array

**MFR\_TEMP\_COEFF (0xE7)**

Description: Coefficient for iout temperature compensation.

Bit	Description	Format
15:0	Coefficient in Q16. iout compensation factor calculated according to: $1 / (1 + t\_coeff * (T - 20))$	Fixed Point Unsigned

**MFR\_IOUT\_APC (0xEA)**

Description: The iout apc gain.

Bit	Description	Format	Unit
15:0	SSet the iout apc gain. the format is Linear 11, Exponent is -9 or -8 (User selection possible). The LSB varies with isen_gain_mode - ISEN_LSB/Secondary current sense resistor (Rsense).	Linear	A

**MFR\_MULTI\_PIN\_CONFIG (0xF9)**

Description: The MFR\_MULTI\_PIN\_CONFIG command can be re-configured to enable or disable different functions and set the pin configuration.

Bit	Function	Description	Value	Function	Description
9	Enable Snapshot Feature	Enables the snapshot feature. When enabled the snapshot function will run once every ms to collect telemetry data and regulator state into ring buffers and to check for OVF, OCF or OTF events.	0		Disabled
			1		Enabled
6:5	Sync Mode		00	Disabled	Sync Pin disabled.

		These bits configures the direction of the sync pin as either SYNC OUT or SYNC IN. Use the INTERLEAVE command to enable/disable the sync function and to configure phase offset.	01	Sync in	When the product is configured as SYNC IN it will synchronize its switching frequency to an external sync signal. The switching phases can be spread individually using the INTERLEAVE command 0x37.
			10	Sync out	When the product is configured as SYNC OUT it will send out a SYNC signal. Only 1 product in a group can be configured as SYNC OUT.
4	Sync Output	Selects the output type of the Sync pin.	0	Open Drain	Sync output configured as Open Drain.
			1	Push/Pull	Sync output configured as Push/Pull.
2	Power Good Pull-down	This bit enables or disables Power Good pin pull-down.	0	Disabled	
			1	Enabled	
1	Power Good Output	Two output options are available for Power Good output, they are Push/Pull or Open Drain.	0	Push/Pull	Power Good configured Push/Pull.
			1	Open Drain	Power Good configured Open Drain.