



Intertek

Key features

- Horizontal mounting non-isolated DC/DC converter
- High power density IBC up to 0.45 kW/cm³
- Ratio conversion 4:1, 800W continuously, 1500W peak power
- Peak efficiency 97.5 %
- LGA industry standard footprint and pinout
- Optimized thermal design for cold wall mounting
- MTBF 7.49 million hours
- Meets safety requirements per IEC/EN/UL 62368-1
- PMBus configuration

Soldering methods

- Pb free SMD reflow

BMR314

Ultra-small Intermediate Bus Converter

The BMR314 is a powerful and compact digital, non-isolated, unregulated DC/DC converter designed to support Artificial Intelligence applications as a first IBC step before voltage regulation module (VRM) or Point of Load (PoL) solutions are used to further convert the desired downstream core voltages.

The converter has a ratio conversion of 4:1 and provides 800W continuous power and has peak power capabilities of up to 1500W.

The BMR314 delivers a power density of more than 0.3kW/cm³ or 5kW/in³ when delivering peak power to the load.

Key electrical information

Parameter	Values
Input range	38-60V
Output voltage	9.5-15V
Output current	62A
Output power	800W
Peak power	1500W

Mechanical

28.2 x 17.8 x 9.65 mm / 1.1 x 0.7 x 0.38 in

Application areas

- Designed for AI applications

Product options

The table below describes the different product options.

Example: BMR314 1 01 1 /001 C							Definitions
Product family	BMR314						
Mech. solution		1					0 = Open frame 1 = Baseplate, LGA
Sequence number			01				01 = Input 38-60 V, Output 9.5-15 V, 800 W continuously, 1500 W peak
Function				1			1 = Stacked module
Configuration code					/001		001 = Default config for Input 38-60 V, Output 9.5-15 V, 800 W continuously, 1500 W peak
Packaging options						C	C = Antistatic tape and reel package

For more information, please refer to [Part 3 Mechanical information](#).

If you do not find the variant you are looking for, please contact us at [Flex Power Modules](#).

Order number examples

Part number	V _{in}	Output	Configuration
BMR3141011/001C	38-60 V	9.5-15 V / 62 A / 800 W	Baseplate / stacked module / antistatic tape and reel package

Part 1: Electrical specifications

Absolute maximum ratings

Stress in excess of our defined *absolute maximum ratings* may cause permanent damage to the converter. Absolute maximum ratings, also referred to as *non-destructive limits*, are normally tested with one parameter at a time exceeding the limits in the electrical specification.

Characteristics	min	max	Unit
Operating temperature (T_{P1})	-20	125	°C
Storage temperature	-40	125	°C
Input voltage (V_{in}) continuous operation	-0.3	60	V
Input voltage transient	-0.3	68	V
C_{out}	0.1	6	mF
Signal I/O voltage (EN, PG, ALERT, ADDR, SCL, SDA)	-0.3	7	V

Reliability

The failure rate (λ) and mean time between failures ($MTBF = 1/\lambda$) is calculated at max output power and an operating ambient temperature (T_A) of +40 °C. Flex Power Modules uses Telcordia SR-332 Issue 4 Method 1 to calculate the mean steady-state failure rate and standard deviation (σ). Telcordia SR-332 Issue 4 also provides techniques to estimate the upper confidence levels of failure rates based on the mean and standard deviation.

	Mean	90% confidence level	Unit
Steady-state failure rate (λ)	134	169	nfailures/h
Standard deviation (σ)	27.2		nfailures/h
MTBF	7.5	5.9	MHr

Typical application diagram

Capacitor values are defined in the Electrical Specification tables. The EMI filter is defined in the EMC Part 2.

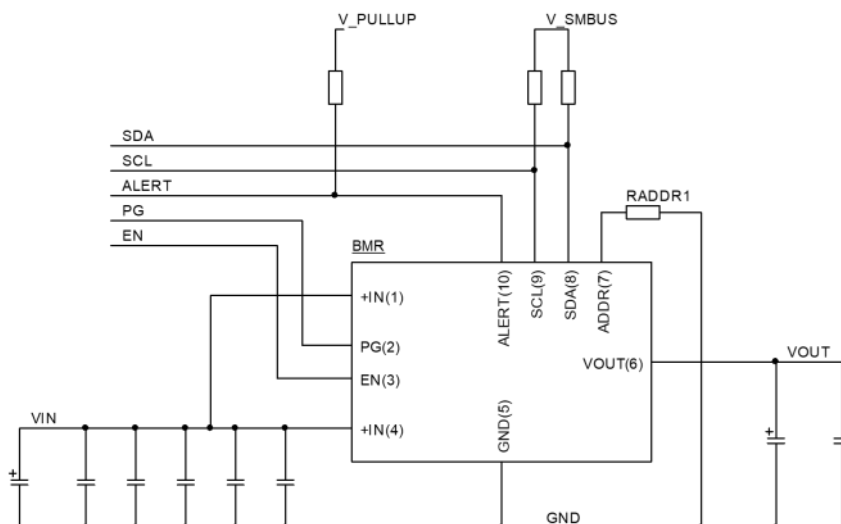

Electrical specifications for BMR3141011/001**13.5 V, 62 A (115 A peak) / 800 W (1500 W peak)**

Min and max values are valid for: $T_{P1} = -20$ to $+95$ °C, $V_{in} = 38$ to 60 V, $I_{out} = 62$ A, unless otherwise specified under conditions. Typical values given at: $T_{P1} = +25$ °C, $V_{in} = 54$ V, max P_{out_TDP} , unless otherwise specified under conditions, see *Note 1*.

Additional external $C_{in} = 470$ μ F + 2 x 2.2 μ F ceramic, $C_{out} = 2$ x 470 μ F

Characteristic	conditions	minimum	typical	maximum	unit
Key features					
Efficiency (η)	Peak		97.5		%
	100 % of P_{out_TDP}		96.5		%
	50 % of P_{out_TDP} $V_{in} = 48$ V		97.3		%
	100 % of P_{out_TDP} $V_{in} = 48$ V		96.2		%
P_{out_TDP} thermal design power (TDP)	See Note 1		800		W
P_{out_MAX} peak power	See Note 1		1500		W
Power dissipation	100 % of P_{out_TDP}		29.4		W
Switching frequency (f_s)	0-100 % of P_{out_TDP}		1250		kHz
Recommended capacitive load		40	470	6000	μ F
Input characteristics					
Input voltage range (V_{in})		38		60	V
Input idling power	$P_{out} = 0$ W		4.9		W
Input standby power	(turned off with EN)		560		mW
Input OVP				68	V
Internal input capacitance			14.1		μ F
Recommended external input capacitance	See Note 2	100			μ F

Note 1: Max. peak power is ≤ 1500 W and continuous power (thermal design power TDP) is ≤ 800 W depending on thermal conditions. Max. output current is rated at 115 A. Max. peak output current is also limited by the Timed OCP threshold and response time, see table Protection features.

*Note 2: Typical value (recommended) is 100 μ F + 5*10 μ F.*

Electrical specifications for BMR3141011/001**13.5 V, 62 A (115 A peak) / 800 W (1500 W peak)**

Min and max values are valid for: $T_{P1} = -20$ to $+95$ °C, $V_{in} = 38$ to 60 V, $I_{out} = 62$ A, unless otherwise specified under conditions. Typical values given at: $T_{P1} = +25$ °C, $V_{in} = 54$ V, max P_{out_TDP} , unless otherwise specified under conditions, see *Note 1*.

Additional external $C_{in} = 470$ μ F + 2 x 2.2 μ F ceramic, $C_{out} = 2$ x 470 μ F

Characteristic	conditions	minimum	typical	maximum	unit
Output characteristics					
Output voltage	$P_{out} = 0$ W		13.54		V
Output voltage	Disabled, no load		2.7		V
Output voltage	Disabled, 1 k Ω load		0.15		V
Output current (I_{out})	$V_{in} = 38 - 60$ V, PG asserted		62	115	A
Output current (I_{out})	Before PG, $V_{in} = 54$ V, $C_{out} = 1.0$ mF, Note 2			31	A
Output current (I_{out})	Before PG, $V_{in} = 38$ V, $C_{out} = 6$ mF, Note 2			9	A
Output voltage droop	I_{out} from 0 to 62 A		407		mV
Output ripple & noise	20 MHz BW, see Note 3		16		mV _{p-p}
Internal output capacitance	$V_{out} = 0$ V			140	μ F
On/off control					
Initialization Time	From $V_{in} > 8.5$ V to ready to be enabled		33		ms
Turn-off input voltage	Decreasing input voltage		32		V
Turn-on input voltage	Increasing input voltage		37		V
On Delay Time	From EN asserted to ramp start		0		ms
Ramp-up time	From 10% to 95% of V_{out} , $I_{out} = 0$ A		6.5		ms
Start-up time	From $V_{in} = 37$ V to PG		36		ms
Enable start-up time	From EN = 600mV to PG		9.8		ms
Logic high: trigger level	EN pin	0.7			V
Logic low: trigger level	EN pin			0.6	V
Source current	EN pin (Internal pull up)			0	μ A
Sink current	EN pin			100	μ A

Note 1: Max. output current is rated at 115 A. Max power is ≤ 1500 W and continuous power (thermal design power (TDP) is ≤ 800 W depending on thermal conditions).

Note 2: Resistive load. The output current value is evaluated after PG. For example, max resistive load before PG at $V_{in} = 38$ V, $C_{out} = 6$ mF is a load that gives 9 A current at $V_{out} = V_{in} / 4 = 9.5$ V

Note 3: See Technical Reference: Application and design considerations.

Electrical specifications for BMR3141011/001**13.5 V, 62 A (115 A peak) / 800 W (1500 W peak)**

Characteristic	conditions	minimum	typical	maximum	unit
Protection features					
Input Under Voltage fault limit (IUVP)	Latch (0x80)		32		V
Input Over Voltage fault limit (IOVP)	Latch (0x80)		68		V
Output Under Voltage fault limit (UVP)	Latch (0x80)		7.5		V
Output Under Voltage warning limit			8.5		V
Output Over Voltage fault limit (OVP)	Latch (0x80)		17		V
Output Over Voltage warning limit			15.5		V
Over temperature fault limit (OTP)	Latch (0x80)		120		°C
Over temperature warning limit	See Note 3		1023		°C
Over Current Protection (OCP) See Note 1	Comparator OCP threshold	150	200		A
	Comparator OCP response time			1	µs
	Average OCP, IOUT_OC_FAULT_LIMIT	115	140		A
	Timed OCP, IOUT_OC_WARN_LIMIT	70	90		A
	Timed OCP response time		37		ms
	Timed OCP response time set point accuracy		0.55		ms
Short circuit output current	T _{P1} = 25 °C, start against short			6.5	A
Protection response time (IUVP, IOVP, UVP, OVP, OTP, Average OCP)	See Note 2	0.75		1	ms

Note 1: Response time = transient duration required to trig an OCP fault. See section Over Current Protection in "Technical Reference: Application and design considerations" for a detailed description of the OCP functionality.

Note 2: The threshold is compared against a moving average value of four samples with 0.25 ms sampling interval. In addition, up to 0.3 ms may pass after a fault is triggered before switching stops.

Note 3: The threshold is set to max logic value to disable the OT warn functionality, to provide robust startup during cold conditions.

Electrical specifications for BMR3141011/001**13.5 V, 62 A (115 A peak) / 800 W (1500 W peak)**

Characteristic	conditions	minimum	typical	maximum	unit
Monitoring & Control					
UVLO _{VI} - Under Voltage Lock-Out	V _{in} rising threshold		8.5		V
	Hysteresis		2.5		V
Power Good Delay Time	From V _{out} = 100 % to PG asserted		0.8		ms
Power Good Threshold	Low to high transition		100		% V _{out}
	High to low transition, Note 1				
V _{IL} - Logic input low	SCL, SDA			0.8	V
V _{IH} - Logic input high	SCL, SDA	1.7			V
V _{OL} - Logic output low	SDA, ALERT, PG			65	mV
I _{OL} - Logic output low sink current	SDA			20	mA
I _{OL} - Logic output low sink current	ALERT, PG			5	mA
I _{LEAK} - Logic leakage current	SDA, SCL, ALERT, PG			10	µA
C _{L_PIN} - Logic input capacitance	SDA, SCL, EN		10		pF
f _{SMB} - SMBus Operating frequency		10		400	kHz
EN - Enable	See page 5 "On/Off control"				

Note 1: Power Good is deasserted when the output voltage is disabled, regardless of the output voltage level.

In the table below all PMBus commands are written in capital letters.

T_{P1} = -20 to + 95 °C, V_{in} = 38 to 60 V, unless otherwise specified under conditions.

Typical values given at: T_{P1} = +25 °C, V_{in} = 54 V, max P_{out_TDP}, unless otherwise specified under conditions

Command	conditions	minimum	typical	maximum	Unit
Monitoring accuracy					
Input voltage READ_VIN			±1		%
Output voltage READ_VOUT			±1		%
Output current READ_IOUT	V _{in} = 54 V, I _{out} = 62 A		±5		%
Temperature READ_TEMPERATURE_1	T ≥ 25 °C		±3		°C

For more detailed information please refer to Technical Reference Document: PMBus commands. This product is supported by the [Flex Power Designer tool](#).

Electrical graphs for BMR3141011/001

13.5 V, 62 A (115 A peak) / 800 W (1500 W peak)

Efficiency

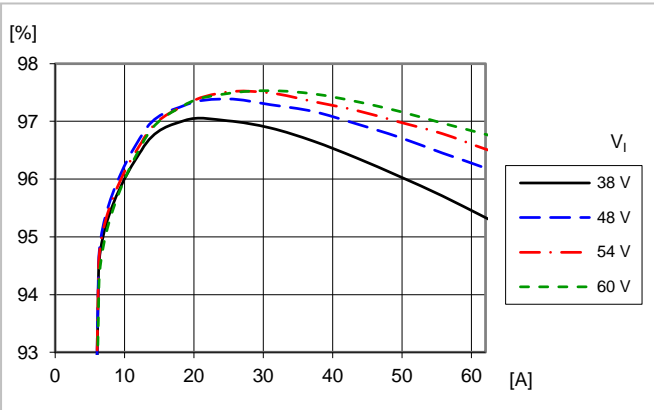

Efficiency vs. output current and input voltage at $T_{P1} = +25\text{ }^{\circ}\text{C}$.

Power dissipation

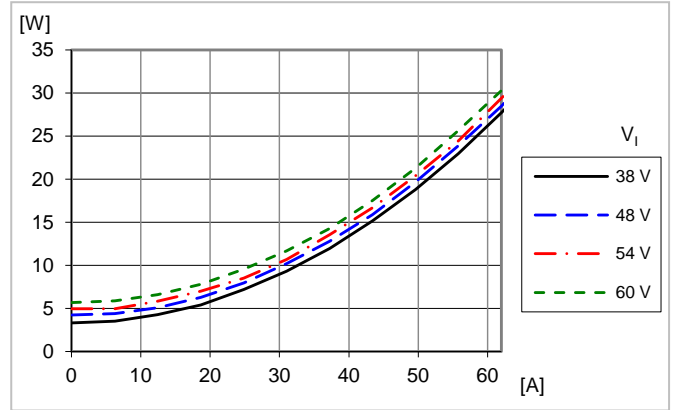

Dissipated power vs. load current at $T_{P1} = +25\text{ }^{\circ}\text{C}$.

Output Ripple and Noise

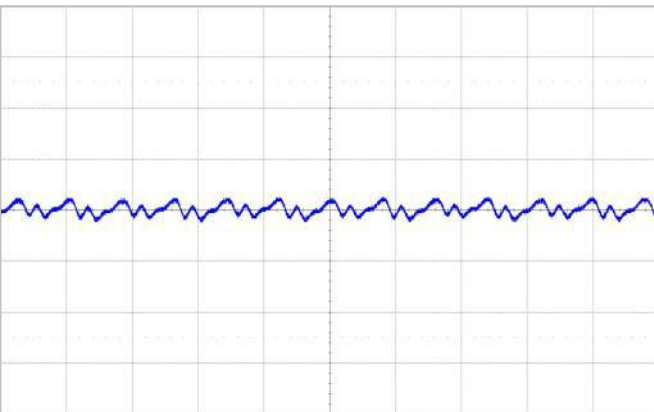

$V_{in} = 54\text{ V}$, $I_{out} = 62\text{ A}$, 20 MHz BW. Scale 20 mV/div, 500 ns/div.

Output voltage droop

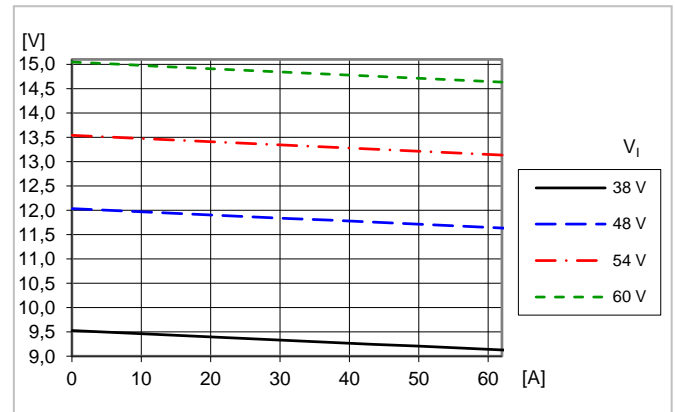

Output voltage vs output current.

Startup

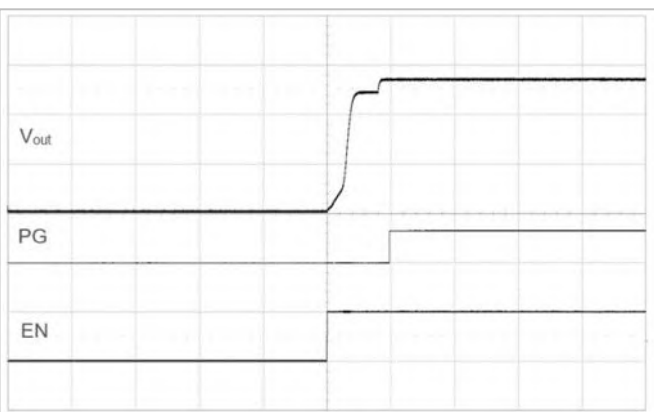

Output enabled by EN pin. $V_{in} = 54\text{ V}$, $I_{out} = 1\text{ A}$
Scale from top: 5, 5, 5 V/div, 10 ms/div.

Shutdown

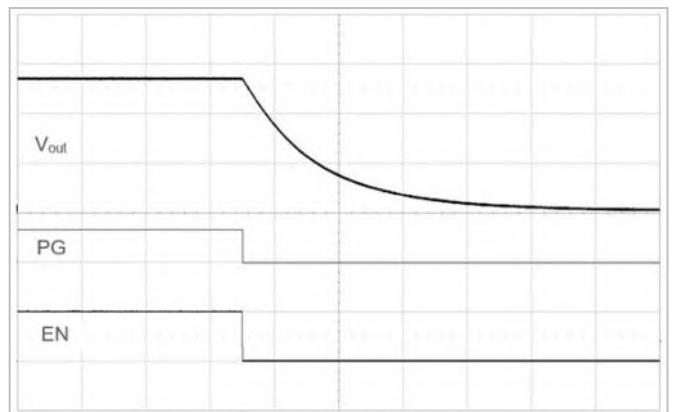

Output disabled by EN pin. $V_{in} = 54\text{ V}$, $I_{out} = 1\text{ A}$
Scale from top: 5, 5, 5 V/div, 10 ms/div.

Part 2: EMC

EMC specifications

Conducted EMI measured according to EN55022 / EN55032, CISPR 22 / CISPR 32 and FCC part 15J (see test set-up below). The fundamental switching frequency is 1.25 MHz for BMR314. The EMI characteristics below is measured at $V_{in} = 54\text{ V}$ and max I_{out} .

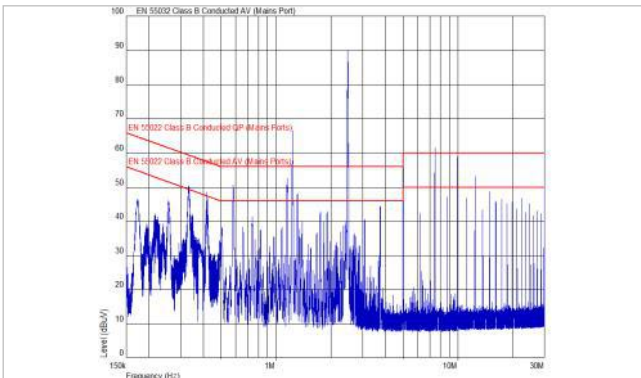

EMI without filter. (Blue graph = QP values)

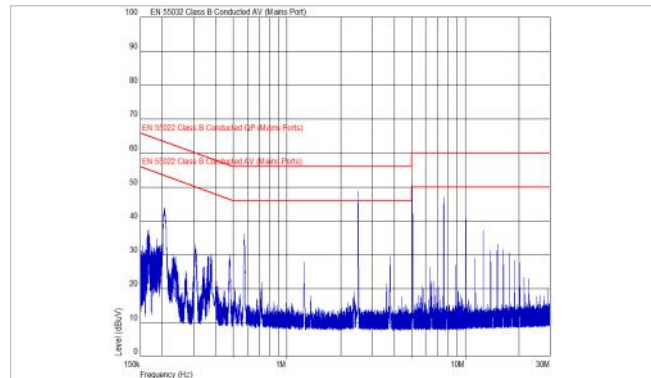

EMI with an optional external filter, EN55032. Test method and limits are the same as EN55022. (Blue graph = QP values)

Optional external filter for Class B

Suggested external input filter in order to meet Class B in EN 55022 / EN 55032, CISPR 22 / CISPR 32 and FCC part 15J.

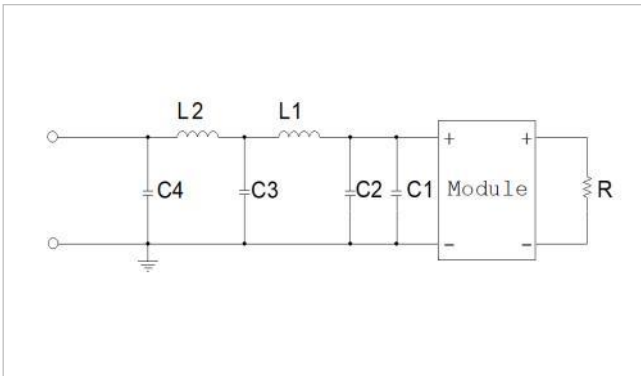

Filter components:

$C1 = 2 \times 2.2\ \mu\text{F} + 100\ \mu\text{F}$ (Oscon)

$C2 = 5 \times 10\ \mu\text{F}$

$C3 = 5 \times 10\ \mu\text{F}$

$L1 = 100\ \text{nH}$

$C4, L2$ not populated.

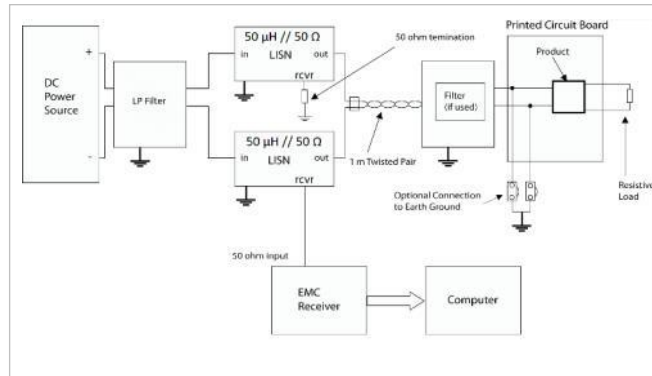

Test set-up

Layout recommendations

The radiated EMI performance of the product will depend on the PCB layout and ground layer design. It is also important to consider the stand-off of the product. If a ground layer is used, it should be connected to the output of the product and the equipment ground or chassis. A ground layer will increase the stray capacitance in the PCB and improve the high frequency EMC performance.

Part 3: Mechanical information

BMR3141011/001: SMD mounted, baseplate version

The mechanical information is based on a module which is SMD mounted and has a baseplate.

Side view

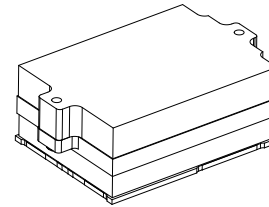
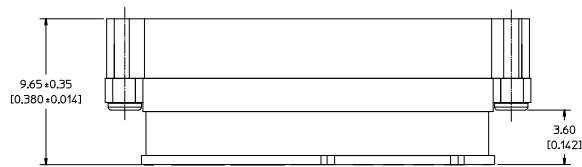

Top view

Product overall X/Y dimension including both top and bottom boards.

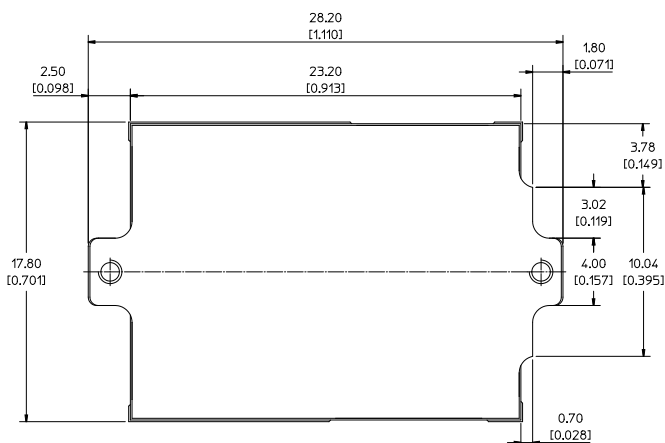

Weight: typical 12.6 g

All dimensions in mm [inches]

Tolerances unless specified:

x.x ±0.5 mm [0.02 inch]

x.xx ±0.25 mm [0.01 inch]

(not applied on footprint or typical values)

All component placements – whether shown as physical components or symbolical outline – are for reference only and are subject to change throughout the product's life cycle, unless explicitly described and dimensioned in this drawing.

BMR3141011/001: SMD mounted, baseplate version

The mechanical information is based on a module which is SMD mounted and has a baseplate.

Pin layout and footprint top view through the product.

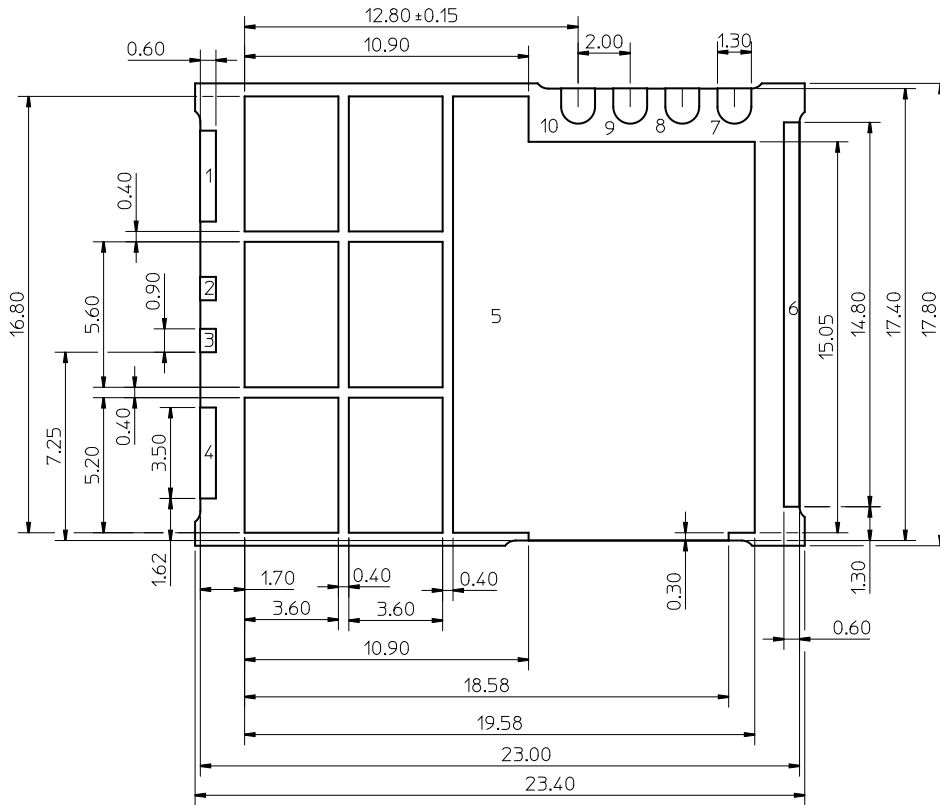

Recommended footprint top view through the product

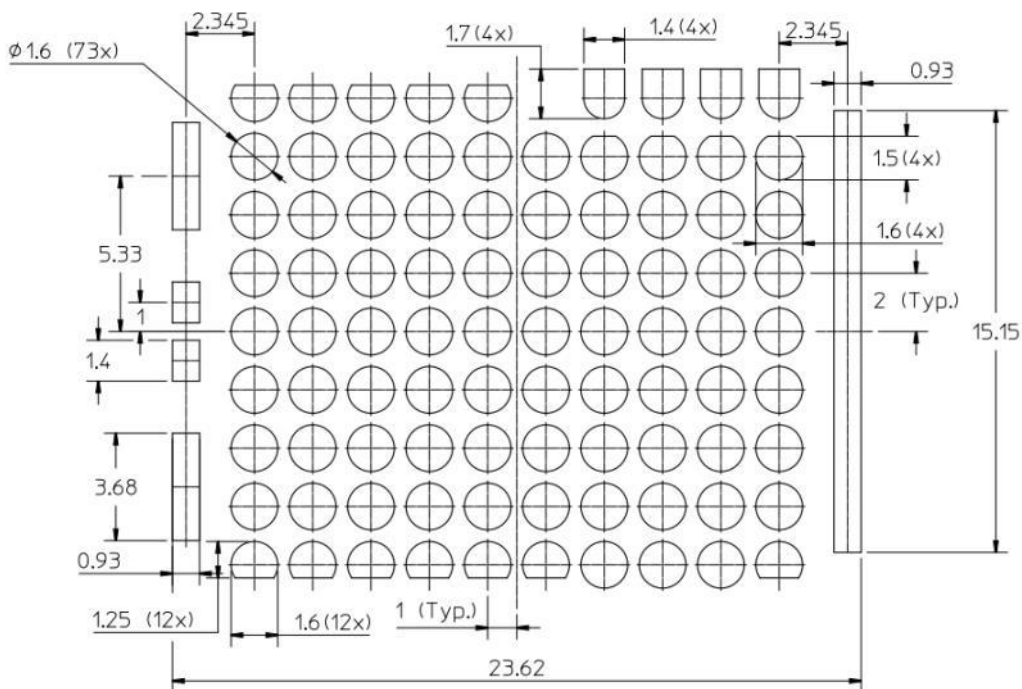

TOP VIEW - Pin-out description and pin positions

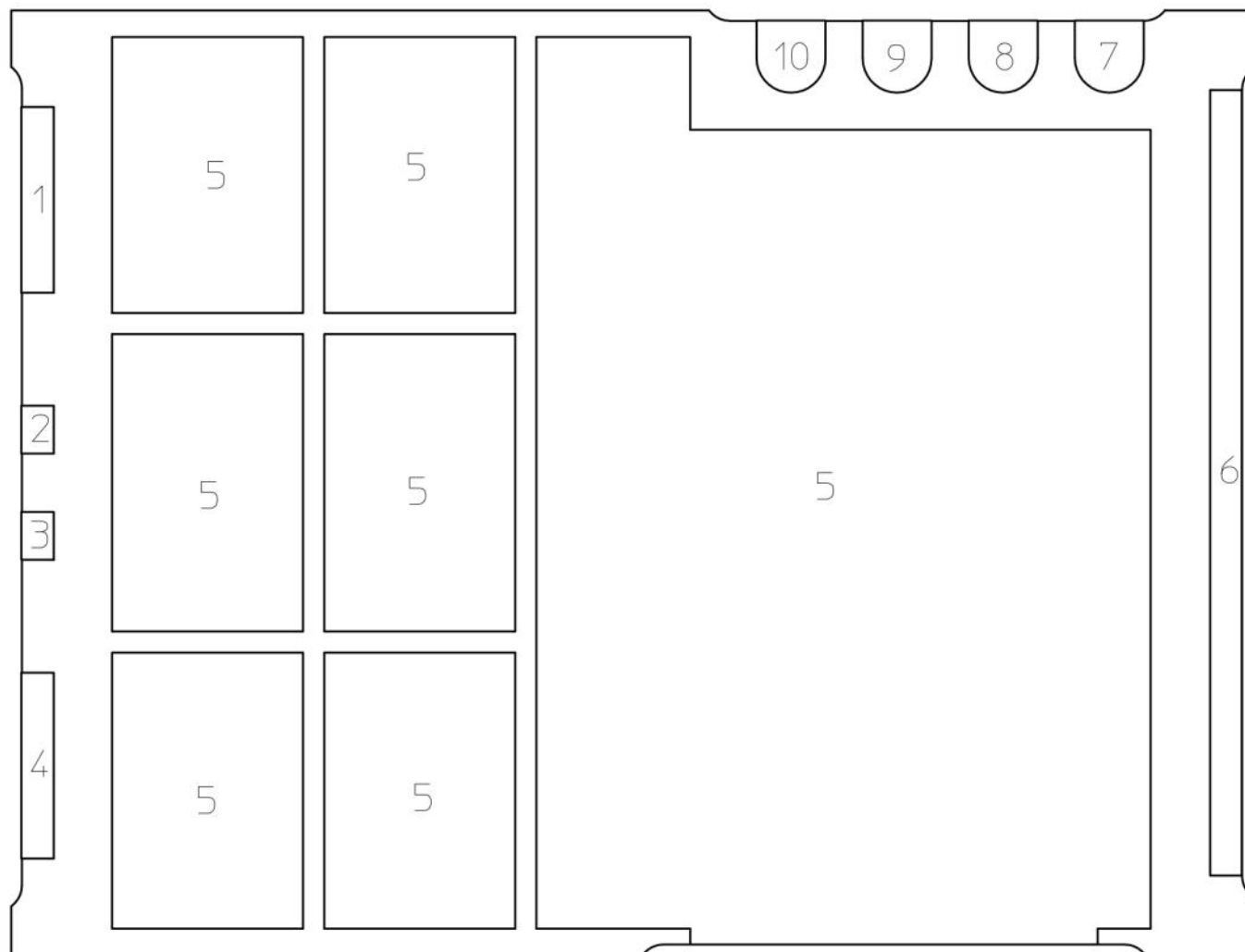

Pin	Designation	Type	Function
1	+IN	Power	Input voltage
2	PG	Open Drain	Power good, active high (has internal pull-up resistor)
3	EN	Input	Enable, active high (has internal pull-up resistor)
4	+IN	Power	Input voltage
5	GND	Power	Power ground
6	VOOUT	Power	Output voltage
7	ADDR	Input	PMBus address pin strap
8	SDA	Input/Output	PMBus data
9	SCL	Input	PMBus clock
10	ALERT	Open Drain	Alert signal, active low. Asserted when an over current warning condition or an over temperature warning condition occurs. Can be connected to GND if unused.

Part 4: Thermal considerations

Thermal considerations

General

The product is designed with power switches on top to operate with top side cooling towards a heat sink or a cold plate. This is required to handle operation with high load. Cooling is also achieved by conduction to the host board and surrounding air. Sufficient cooling must be provided to ensure reliable operation.

The Output Current Derating graph found in the Electrical Specification section provides the available output current versus case temperature and host board temperature.

Test Setup – Cold Plate

The product is tested in a box with two heater/coolers; one as a cold plate to control the temperature at the top of the product, another on the bottom side of the test board to control the host board temperature. The test board used is 130 x 160 mm in size with 1.6 mm thickness and 6 layers of 3 oz.

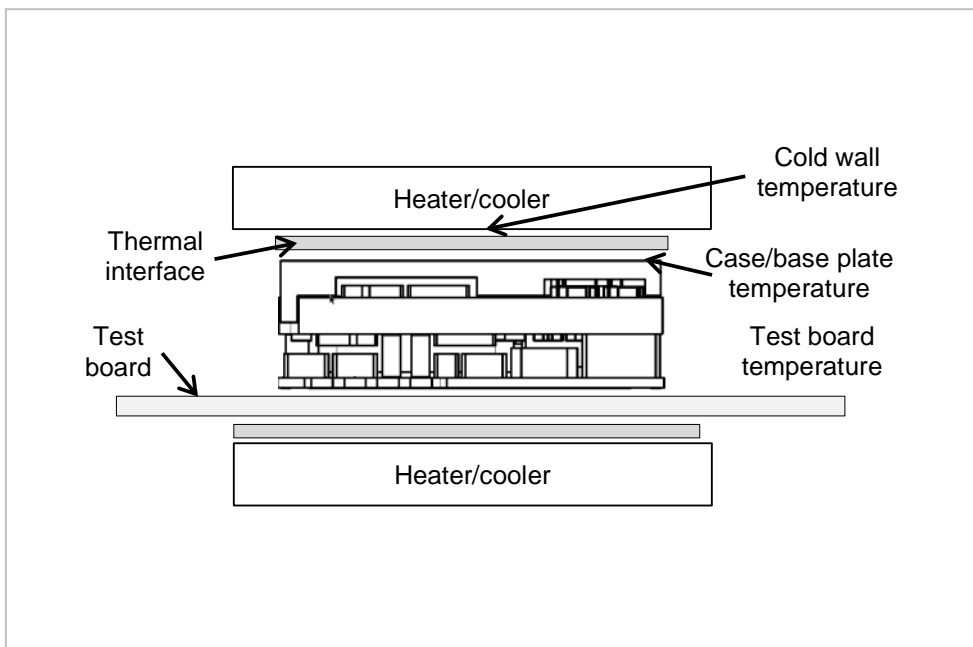

Test set-up: Cold plate

Definition of product operating temperature

The product operating temperatures are used to monitor the temperature of the product, and proper thermal conditions can be verified by measuring the temperature at positions P1, P2, P3. The temperature at these positions (T_{P1} , T_{P2} , T_{P3}) should not exceed the maximum temperatures in the table below. The number of measurement points may vary with different thermal design and topology. Temperatures above maximum are not allowed and may cause permanent damage.

Position	Description	Max. Temp.
P1	MOSFET case	$T_{P1} = 125\text{ °C}$
P2	MOSFET case	$T_{P2} = 125\text{ °C}$
P3	Magnetic core	$T_{P3} = 125\text{ °C}$
P4	PCB side, close to P1	$T_{P4} = 125\text{ °C}$

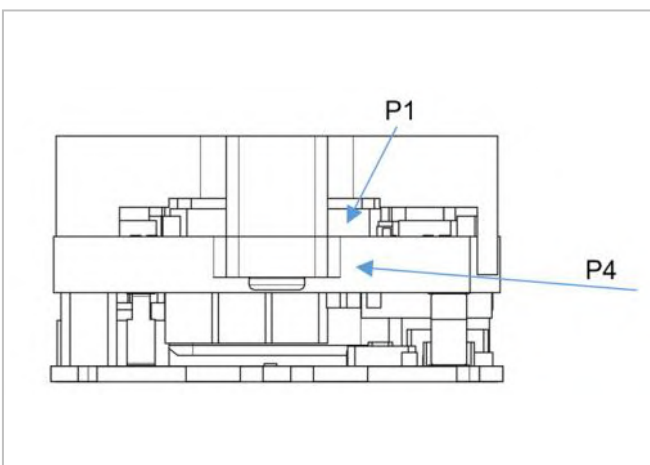

Temperature position (short side view).
Alternative position P4, see note 1.

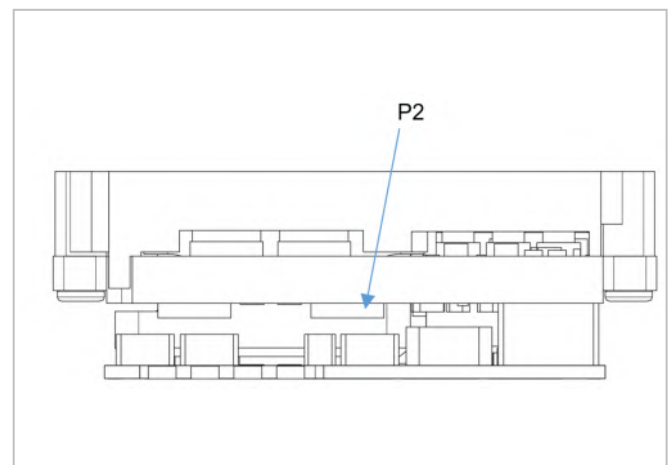

Temperature position (long side view).

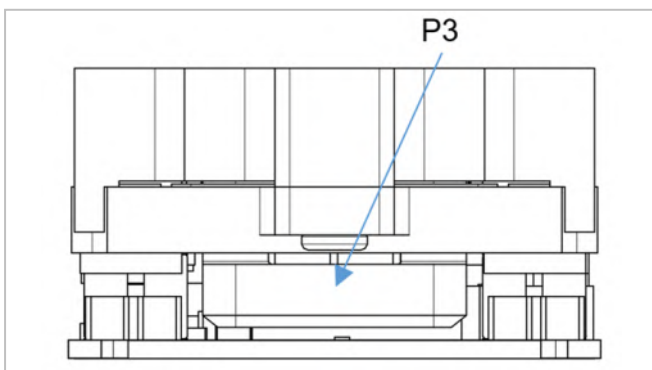

Temperature position (short side view).

Note 1: A temperature probe glued at position P1 may connect with the baseplate, causing a faulty temperature reading. Therefore, a probe glued to the side of the PCB, position P4, can be used instead, since the temperature at P4 is close to the temperature at P1.

Thermal graphs

Output current derating

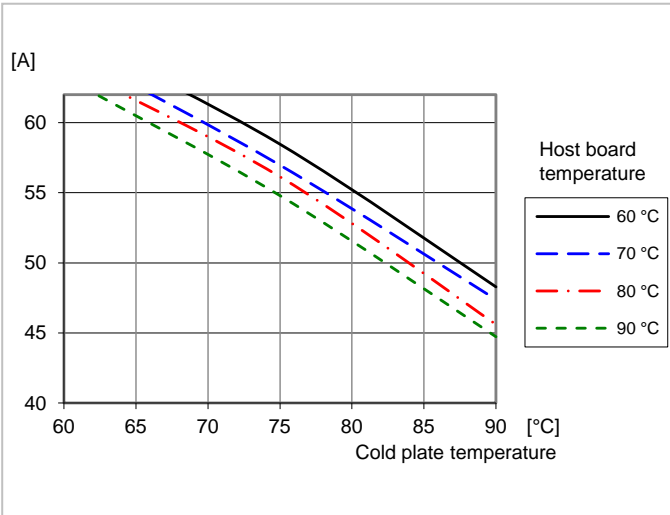

Max. average output current vs. cold plate temperature and host board temperature. Thermal interface gap pad 1.0 mm, 8 W/mK.

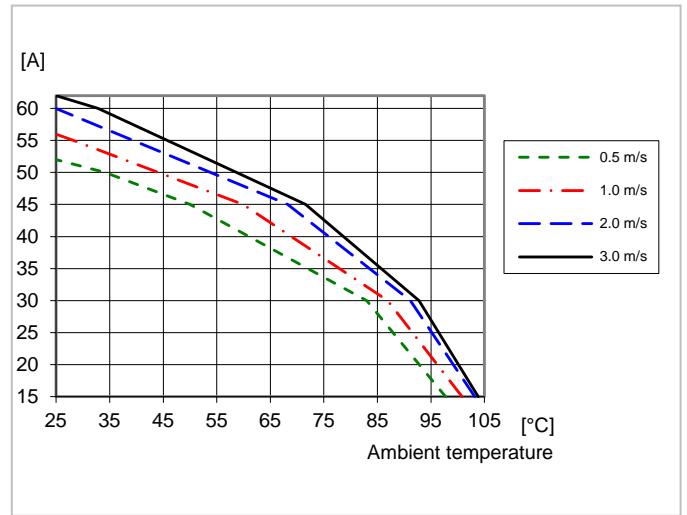

Max. average output current vs. ambient temperature and wind speed, using a 1 inch heatsink ATS-1141-C1-R0. Thermal interface gap pad 1.0 mm, 8 W/mK.

Peak current capability

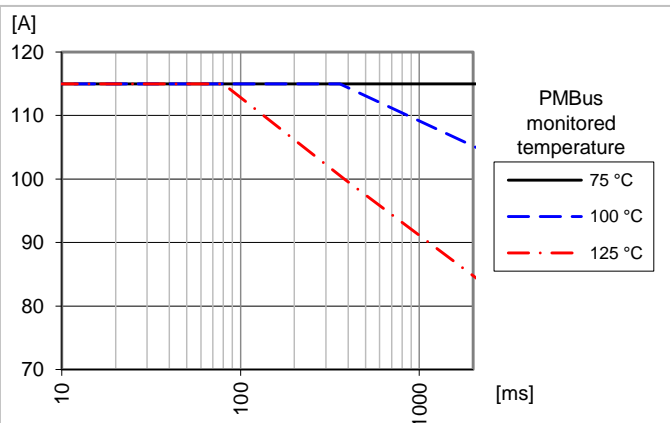

Max. peak output current vs pulse duration and PMBus monitored temperature when pulse starts. Initial Iout = 70 A. Simulated limit given by max. internal junction temperature (150 °C) of hotspot component. In practise, the max. peak current is also limited by the Timed OCP threshold and response time.

For more information, please refer to our [thermal models](#) on the website.

Part 5: Packaging

Packaging information

The products are delivered in antistatic carrier tape (EIA 481 standard).

Carrier Tape Specifications	
Material	PS, Antistatic
Surface resistance	$< 10^7 \Omega/\text{square}$
Bakability	The tape is not bakeable
Tape width, W	56 mm
Pocket pitch, P1	28 mm
Pocket depth, K0	10.8 mm
Reel diameter	330 mm
Reel capacity	150 products /reel
Reel weight	2450 g/full reel

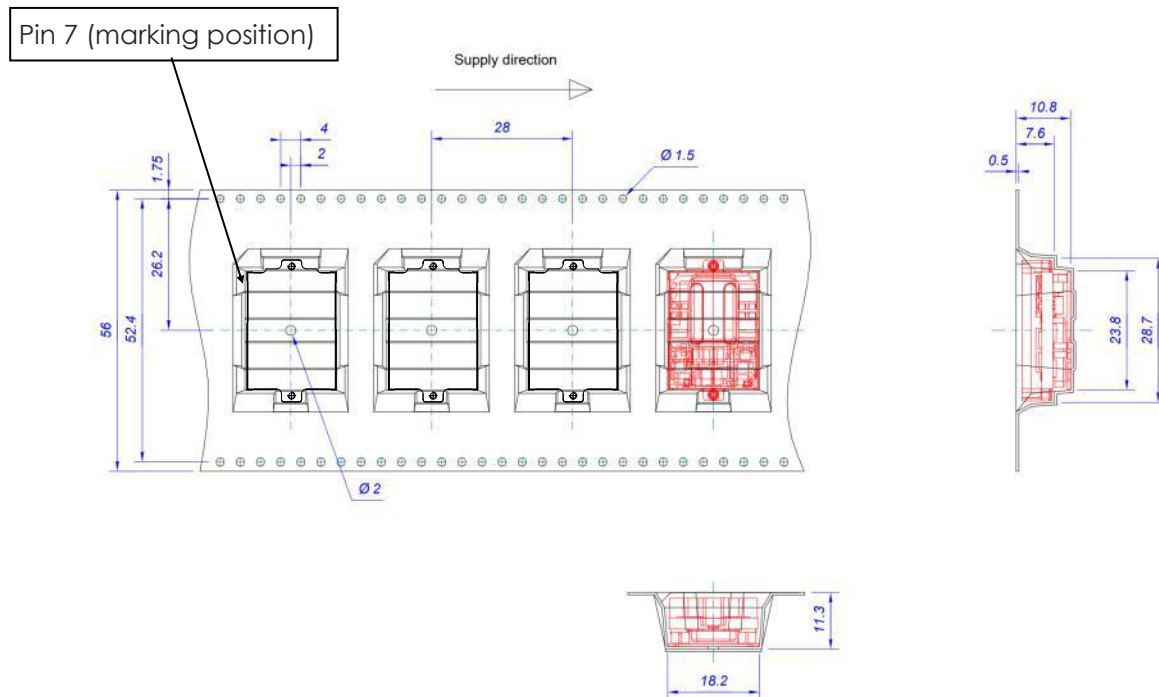

Part 6: Revision history**Revision table**

Revision number	revision change	date	revisor
Rev. A	New document.	2024-02-02	KARFWAHL
Rev. B	General corrections and an additional thermal graph describing output current derating with wind cooling.	2024-09-16	KARJNILS
Rev. C	Minor updates.	2024-09-25	KARTWAER
Rev. D	Updated tolerance for product overall dimension.	2024-09-25	KARALARS
Rev. E	Minor changes.	2024-09-27	KARJNILS
Rev. F	Corrected typos in Product options and Order number examples.	2024-10-08	JIDGEZOU
Rev. G	Changed OT warn limit to 1023 °C, added Note 3 on page 6.	2024-10-11	KARALARS
Rev. H	Formatting updates.	2024-10-16	KARTWAER
Rev. J	Clarified peak power capability on page 4 (Note 1) and page 15 (graph + text).	2024-10-21	KARALARS
Rev. K	Minor changes to mechanical and packaging information.	2024-10-25	JIDJLIAA
Rev. L	Clarified information about pull-up resistors for EN and PG.	2024-11-28	KARCLYRB

© Flex Power Modules 2024

The information and specifications in this document is believed to be correct at the time of publication. However, no liability is accepted for inaccuracies, printing errors or for any consequences thereof. Flex reserves the right to change the contents of this document at any time without prior notice.

flex[®]

Flex Power Modules, a business line of Flex, is a leading manufacturer and solution provider of scalable DC/DC converter primarily serving the data processing, communications, industrial and transportation markets. Offering a wide range of both isolated and non-isolated solutions, its digitally-enabled DC/DC converters include PMBus compatibility supported by the powerful [Flex Power Designer](#).



TECHNICAL REFERENCE DOCUMENT: DESIGN & APPLICATION GUIDELINES

OPERATING INFORMATION

Input Voltage

The input voltage range 38 to 60 V (dc) meets the requirements for normal input voltage range in 48 V systems, 40.5 to 57.0 V.

Short duration transient disturbances can occur on the DC distribution and input of the product when a short circuit fault occurs on the equipment side of a protective device (fuse or circuit breaker). The voltage level, duration and energy of the disturbance are dependent on the particular DC distribution network characteristics and can be sufficient to damage the product unless measures are taken to suppress or absorb this energy. The transient voltage can be limited by capacitors and other energy absorbing devices like zener diodes connected across the positive and negative input conductors at strategic points in the distribution network. The end-user must secure that the transient voltage will not exceed the value stated in the Absolute maximum ratings. ETSI TR 100 283 examines the parameters of DC distribution networks and provides guidelines for controlling the transient and reduce its harmful effect.

Turn on and off input voltage

The product monitors the input voltage and will turn on and turn off at configured thresholds (see Electrical Specification). The turn-on input voltage threshold, defined by command VIN_ON (0x35), is set higher than the corresponding turn-off threshold, defined by command VIN_UV_FAULT_LIMIT (0x59). Hence, there is a hysteresis between turn-on and turn-off input voltage levels.

Input voltage transient

The end-user must secure that the transient voltage will not exceed the value stated in the *Datasheet under Absolute maximum ratings* of each product. ETSI TR 100 283 examines the parameters of DC distribution networks and provides guidelines for controlling the transient and reduce its harmful effect.

Input and Output Impedance

The impedance of both the input source and the load will interact with the impedance of the product. It is important that the input source has low characteristic impedance. Minimum recommended external input capacitance is 100 μ F. The electrolytic capacitors will be degraded in low temperature. The needed input capacitance in low temperature should be equivalent to 100 μ F at 20 °C.

External decoupling capacitors

When powering loads with significant dynamic current requirements, the voltage regulation at the point of load can be improved by addition of decoupling capacitors at the load.

The most effective technique is to locate low ESR ceramic and electrolytic capacitors as close to the load as possible, using several parallel capacitors to lower the effective ESR. The ceramic capacitors will handle high-frequency dynamic load changes while the electrolytic capacitors are used to handle low frequency dynamic load changes. It is equally important to use low resistance and low inductance PCB layouts and cabling.

Enabling Output Voltage

The output voltage is controlled by the EN pin and/or the PMBus command OPERATION, depending on the settings of the standard PMBus command ON_OFF_CONFIG. Both active high and active low logic of the EN pin is supported.

By default the output voltage is enabled by the EN pin only (OPERATION is ignored), using active high logic.

The EN pin has an internal 56 k Ω pull-up resistor to 5 V. The external device must have a sufficient sink current ability to be able pull EN pin voltage down below logic low threshold level (see Electrical Characteristics).

Care must be taken not to toggle EN pin when $V_{in} < V_{IN_ON}$ (PMBus register) and the unit is not operating. If this is done, the PG logic will be locked to low and will not be asserted when V_{out} is good.

Soft-start

Once enabled, the output voltage will ramp up to a 4:1 ratio of the input voltage. The ramp up is controlled monotonic and performed in three steps:

1. A small constant phase shift with low energy transfer. The linear ramp is monitored to detect a short circuit on the output. If the output voltage is not rising as expected, switching will stop.
2. Primary side FETs ramp-up. A slow soft increase of duty cycle until the phase shift reaches 50%.
3. Approaching the end of the soft start, the secondary FETs are enabled, slowly increasing the on duration of the FETs.

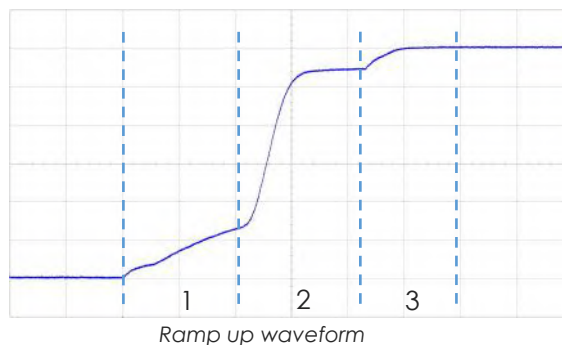

Pre-bias start-up

The product has a pre-bias start up functionality and will not sink current during start up if a pre-bias source is present at the output terminals. If the pre-bias voltage is lower than the target value, the product will ramp up to the target value. If the pre-bias voltage is higher than the target value, the product will ramp down to the target value and in this case sink current.

Over temperature protection (OTP)

The product is protected from thermal overload by an internal over temperature shutdown function. The temperature sensor is located to provide a temperature representative of the module hot spot P1, see section Thermal Considerations in the datasheet.

The temperature is continuously monitored and when the temperature rises above the configured fault threshold level the product will respond as configured. The product can respond in several ways as follows:

1. Immediate and definite shutdown of output voltage until the output voltage is re-enabled (latch).
2. Ignore fault and continue operation.
3. Automatic restart (hiccup).

Default response is option 1. The default OTP limit is specified in section Electrical Characteristics in the datasheet.

The OTP fault and warning limits and response are configured using the PMBus commands OT_FAULT_LIMIT, OT_WARN_LIMIT and OT_FAULT_RESPONSE.

Input Voltage Protections (IUVP, IOVP)

The product monitors the input voltage continuously. If the output voltage is enabled, and the input voltage falls below or rises above the configured threshold levels (see Electrical Specification) the product will respond as configured. The response can be configured in different ways:

1. Immediate and definite shutdown of output voltage until the output voltage is re-enabled (latch).
2. Ignore fault and continue operation.
3. Automatic restart (hiccup).

The default response is option 1.

The protections are configured using the PMBus commands: VIN_UV_FAULT_LIMIT, VIN_UV_FAULT_RESPONSE, VIN_OV_FAULT_LIMIT and VIN_OV_FAULT_RESPONSE.

Output Voltage Protection (UVP, OVP)

The product includes functionality for under and over voltage warnings and protection of the output voltage. The product can be configured to respond in different ways when the UVP/OVP fault limit is passed:

1. Immediate and definite shutdown of output voltage until the output voltage is re-enabled (latch).
2. Ignore fault and continue operation.
3. Automatic restart (hiccup).

The default response is option 1.

The limits and fault responses are configured using the PMBus commands VOUT_UV_FAULT_LIMIT, VOUT_OV_FAULT_LIMIT, VOUT_UV_WARN_LIMIT, VOUT_OV_WARN_LIMIT, VOUT_UV_FAULT_RESPONSE and VOUT_OV_FAULT_RESPONSE.

Over current protection (OCP)

The product includes robust current limiting functionality for protection at overload transients during peak power operation. The OCP function has three parts:

- Comparator OCP. Fast detection by an analog comparator that reacts on pulses down to a microsecond.
- Average OCP. The threshold, set by PMBus command `IOUT_OC_FAULT_LIMIT`, is compared against the average value of the four last samples of the output current, with 250 μ s sampling interval.
- Timed OCP. A timed protection that ensures that component hotspot never exceeds the maximum rated temperature, for transients where the OTP protection is not fast enough. During any time interval T_{WARN} the output current is allowed to be over the threshold $I_{\text{O_WARN}}$ for a maximum accumulated period of half the time of T_{WARN} , or an OCP fault will be triggered.

$I_{\text{O_WARN}}$ is configured by PMBus command `IOUT_OC_WARN_LIMIT`, and the time T_{WARN} is configured by PMBus command `MFR_IOUT_WARN_TIME`.

Below figure summarizes the impact of the OCP functions:

- Transients with a duration up to 0.75 ms must be below the comparator threshold level.
- Transients with a duration in the range 0.75 ms to $T_{\text{WARN}}/2$ must be below the average OCP threshold. If the transients are too frequent, they must also be below the timed OCP threshold.
- Transients with a duration above $T_{\text{WARN}}/2$ must be below the timed OCP threshold.
- OTP will protect the unit at longer pulses and DC operation.

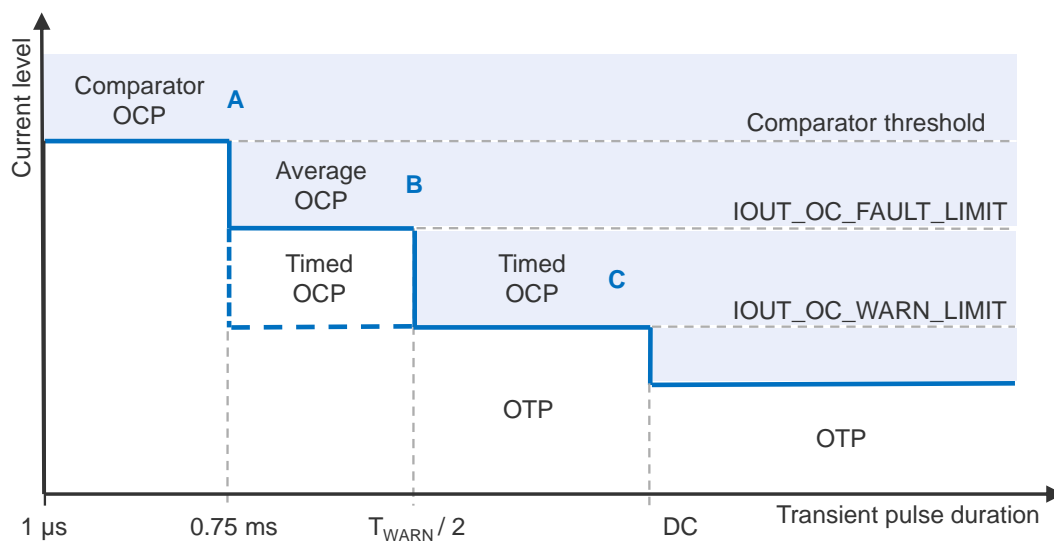

Max current level vs transient pulse duration and areas where OCP and OTP protections affect operation.

The pulse durations specified below are theoretical values at constant temperature. In practise, a current transient will cause a temperature rise of the current sensing element. The consequence of this is that a longer transient duration than the specified response time (1 μ s, 0.75 ms or $T_{\text{WARN}}/2$) may be required before the corresponding OCP is triggered.

The default values of the OCP protection thresholds and T_{WARN} time are listed in section Electrical Specification – Control and Monitoring.

The comparator OCP is always enabled with a latched response, while for the average OCP and timed OCP different response options are available:

1. Immediate and definite shutdown of output voltage until the output voltage is re-enabled (latch).
2. Ignore fault and continue operation.
3. Automatic restart (hiccup).

The default response is option 1. The response options are configured using the PMBus command `IOUT_OC_FAULT_RESPONSE`.

Short circuit protection

During soft start the output voltage ramp is continuously monitored to detect a short circuit on the output. If the output voltage is not rising as expected, switching will stop.

Power good

The power good pin (PG) indicates when the product is ready to provide output voltage to the load. After initialization, the PG pin is asserted low (open drain) until the output voltage is enabled and the soft-start procedure has finalized. The product also provides a power good flag in the `STATUS_WORD` command.

The PG pin has an internal pull-up resistor 10 kohm to +5 V and a pull-down resistor 20 kohm to GND.

Note on PG pin:

Care must be taken not to toggle EN pin when $V_{\text{in}} < V_{\text{IN_ON}}$ (PMBus register) and the unit is not operating. If this is done, the PG logic will be locked to low and will not be asserted when V_{out} is good.

Temperature and current alert

The ALERT pin will be asserted low (open drain) when an over temperature warning condition or an over current warning condition occurs. The ALERT pin will be de-asserted automatically after the timer duration specified by the PMBus command `MFR_IOUT_WARN_TIME`. If the warning condition remains when the timer has expired, the timer restarts, and the ALERT pin will remain asserted. The over temperature warning and over current warning thresholds are defined by the PMBus commands `OT_WARN_LIMIT` and `IOUT_OC_WARN_LIMIT`.

Note that the `MFR_IOUT_WARN_TIME` setting also affects the timed OCP, see section Over Current Protection in this document.

Output ripple and noise

Output ripple and noise measured according to figure below using *evaluation board ROA 170256*. See Design Note 022 for detailed information

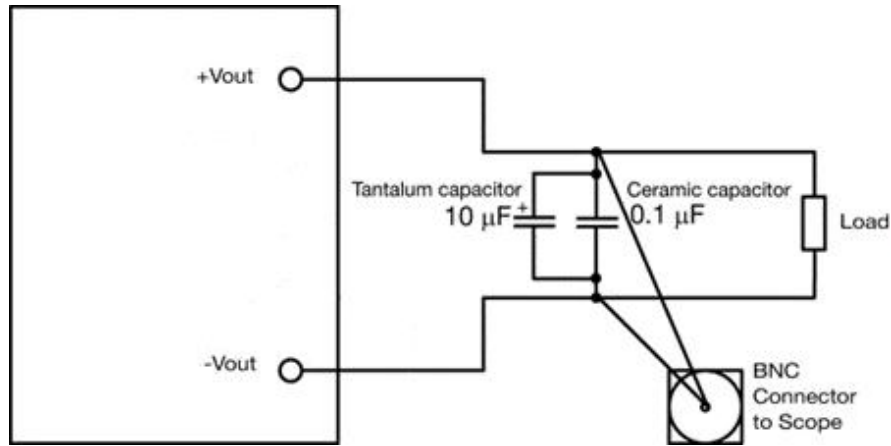

Output ripple and noise test setup

Non-Volatile Memory (NVM)

The product incorporates a Non-Volatile Memory implemented with OTP (One-Time Programmable) technology. However, the memory structure imitates a multi-time programmable memory and can hold 32 updates.

The NVM is pre-loaded with Flex factory default values. The values in NVM are loaded to RAM during initialization after application of input voltage, whereafter commands can be changed through the PMBus Interface. Changes can be stored to NVM using the command OTP_UPLOAD (0xD6) which writes configuration changes in RAM to the OTP memory.

The user can read the command OTP_WRITE (0xCF) to find out the remaining number of possible store cycles, before OTP_UPLOAD (0xD6) is used.

Parallel operation

Two or more products may be paralleled for redundancy. The products provide output voltage droop resistance in secondary transformer winding, which enables direct paralleling. To achieve optimum operation when paralleling modules, it is important to ensure the same PCB routing path resistances between the input terminals and merged output terminals. The output voltage will decrease with increased load current. This feature allows the product to be connected in parallel and share current within 10% accuracy at max output power. This means that up to 90% of max rated current from each module can be utilized.

In applications with several modules in parallel, the PG signal of all modules should be connected together. Further, load shall not be applied unless PG signal is high (= all modules have successfully ramped up).

For further information please contact your local Flex Power Modules' representative or email us at pm.info@flex.com.

Layout recommendation for parallelling

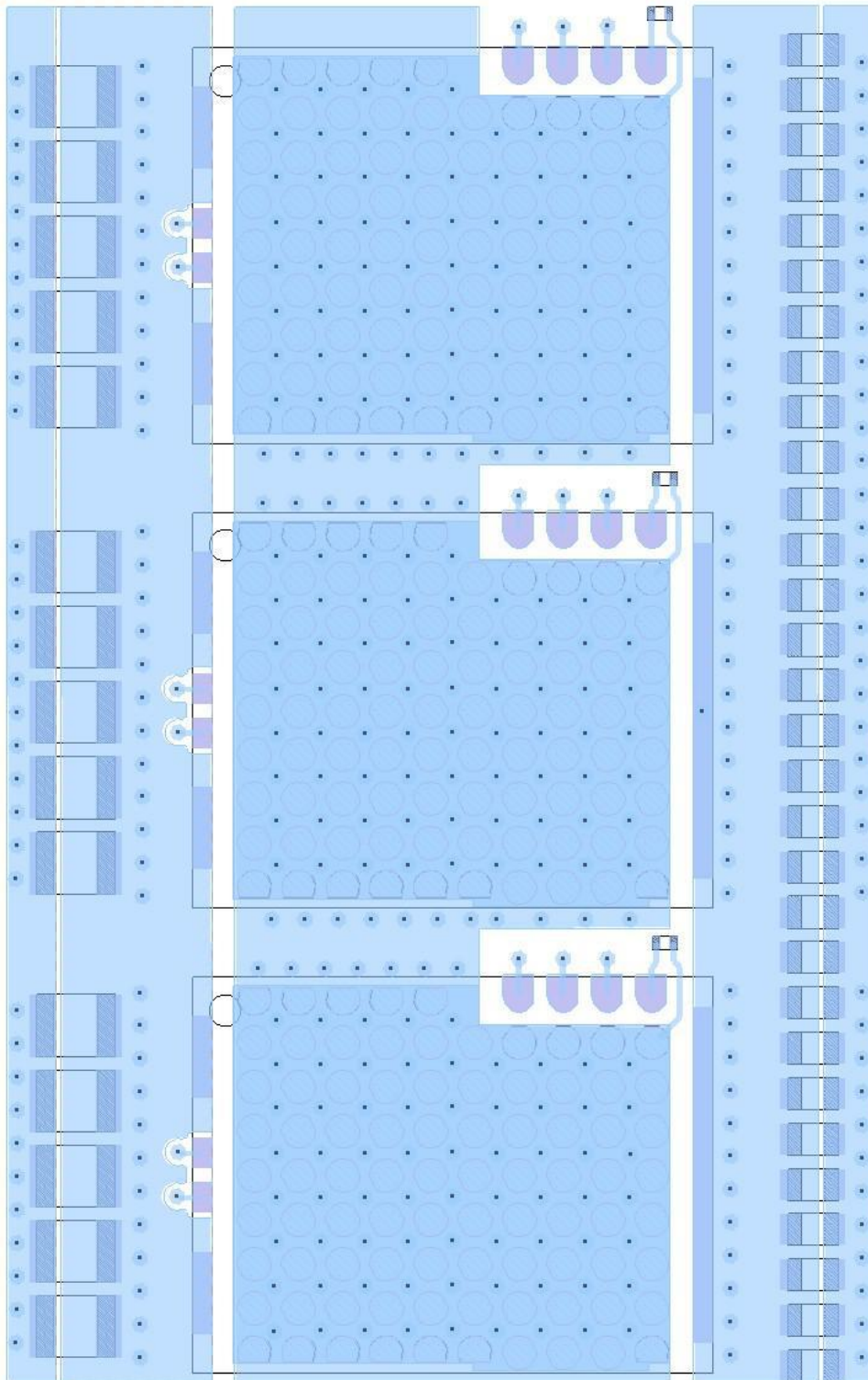

Layout for parallelling

POWER MANAGEMENT

PMBUS overview

This product is equipped with a PMBus interface. The product incorporates a wide range of readable and configurable power management features that are simple to implement with a minimum of external components. Additionally, the product includes protection features that continuously safeguard the load from damage due to unexpected system faults. A fault is also shown as an alert on the SALERT pin. The following product parameters can continuously be monitored by a host: Input voltage, output voltage/ current and internal temperature.

The product is delivered with a default configuration suitable for a wide range operation in terms of input voltage, output voltage, and load. The configuration is stored in an internal Non-Volatile Memory (NVM). All power management functions can be reconfigured using the PMBus interface.

Throughout this document, different PMBus commands are referenced. The Flex Power Designer software suite can be used to configure and monitor this product via the PMBus interface. More information is found on [our website](#).

SMBus interface

This product provides a PMBus digital interface that enables the user to configure many aspects of the device operation as well as to monitor the input and output voltages, output current and device temperature. The product can be used with any standard two-wire I²C (master must allow for clock stretching) or SMBus host device. The product is compatible with PMBus version 1.2 and supports 100 kHz and 400 kHz bus clock frequency. The SMBus signals, SCL and SDA, require passive pull-up resistors as stated in the SMBus Specification. Pull-up resistors must be selected to guarantee rise and fall times according to I²C and SMBus specifications:

Max rise/fall time [ns]	Rise/fall time measurement limits [V]	Specification
300	0.65 to 1.5	SMBus
300	$(0.3 \times V_{DD} - 0.15)$ to $(0.7 \times V_{DD} + 0.15)$	I ² C

V_{DD} = External SCL/SDA pull-up voltage.

The maximum allowed bus load is 400 pF. The pull-up resistor should be tied to an external supply $V_{DD} = 2.5 - 5.5$ V, which should be present prior to or during power-up. If the proper power supply is not available, voltage dividers may be applied.

PEC (Packet Error Check) is not supported for this product. Therefore, it is recommended to use a strong low-value pull-up resistor, but not lower than 270 ohm, to achieve the shortest rise time and the best signal integrity.

PMBus addressing

The PMBus address is configured with a resistor, R_{ADDR} , connected between the ADDR pin and GND. The value of the resistor decides an index according to the table below. The tolerance of the resistor must be 1% or better.

Index	R_{ADDR} [k Ω]	Suggested 1% R_{ADDR} [k Ω]
0	0 – 0.143	0
1	0.418 – 0.658	0.47
2	0.959 – 1.165	1
3	1.494 – 1.753	1.6
4	2.114 – 2.497	2.2
5	2.899 – 3.448	3.3
6	3.903 – 4.701	4.3
7	5.228 – 6.373	5.6

Index	R_{ADDR} [k Ω]	Suggested 1% R_{ADDR} [k Ω]
8	7.000 – 8.645	8.2
9	9.413 – 11.819	10
10	12.796 – 16.328	15
11	17.626 – 22.982	22
12	24.802 – 34.857	33
13	37.761 – 59.808	47
14	65.637 – 119.177	100
15	135.731 - open	open

The PMBus address is calculated as:

$$\text{PMBus Address} = \text{Base Address} + \text{Index}$$

where the base address is defined by bits [7:5] in the PMBus command `PMBUS_ADDRESS` (0xE0). The standard default value for the base address is 0x60, giving an address range from 0x60 to 0x6F. Specific product variants may have a different default value.

If changing the base address, the change will take effect after the input voltage is cycled.

I2C/SMBus timing

The setup time, t_{set} , is the time data, SDA, must be stable before the rising edge of the clock signal, SCL. The hold time t_{hold} , is the time data, SDA, must be stable after the rising edge of the clock signal, SCL. If these times are violated incorrect data may be captured or meta-stability may occur and the bus communication may fail. All standard SMBus protocols must be followed, including clock stretching.

This product supports the BUSY flag in the status commands to indicate product being too busy for SMBus response. A bus-free time delay between every SMBus transmission (between every stop & start condition) must occur. Refer to the SMBus specification, for SMBus electrical and timing requirements.

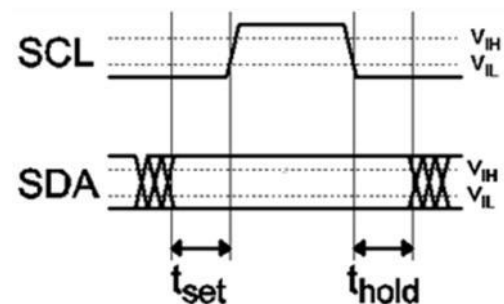

Set-up and hold timing diagram

Monitoring via PMBus

It is possible to continuously monitor a wide variety of parameters through the PMBus interface. These include, but are not limited to, the parameters listed in the table below.

Parameter	PMBus command
Input voltage	READ_VIN
Output voltage	READ_VOUT
Output current	READ_IOUT
Output power	READ_POUT
Temperature	READ_TEMPERATURE_1

These PMBus commands are updated every 0.25 ms.

The temperature sensor is located to provide a temperature reading representative of the module hot spot P1, see section Thermal Considerations in the datasheet.

Monitoring faults

The user may read PMBus status commands to find out what fault or warning condition occurred, see table below:

Fault and warning status	PMBus command
Overview, Power Good	STATUS_BYTE STATUS_WORD
Output voltage level	STATUS_VOUT
Output current level	STATUS_IOUT
Input voltage level	STATUS_INPUT
Temperature level	STATUS_TEMPERATURE
PMBus communication	STATUS_CML
Miscellaneous	STATUS_MFR_SPECIFIC

Status bits are asserted until faults and/or warnings are cleared by the CLEAR_FAULTS (0x03) command. A re-enable of the output voltage will not clear the status bits.

General PMBus comand summary

PMBus signal interfaces characteristics

Characteristic	conditions	minimum	typical	maximum	unit
PMBus signal interface characteristics					
Logic output low signal level	SDA, ALERT, PG, sink/ source current = 5 mA			0.065	V
Logic output low sink current	SDA			20	mA
Logic input low threshold	SCL, SDA			0.8	V
Logic input high threshold		1.7			V
Logic pin input capacitance	SCL, SDA		10		pF
Logic leakage current	SCL, SDA, ALERT, PG			10	µA
Supported SMBus operating frequency		100		400	kHz
SMBus bus free time	STOP bit to START bit		1.3		µs
SMBus SDA setup time from SCL			100		µs
SMBus SDA hold time from SCL			0		ns
SMBus START/STOP condition setup/hold time from SCL			600		ns
SCL low period		1.3			µs
SCL high period			0.6	50	µs

TECHNICAL REFERENCE DOCUMENT: GENERAL INFORMATION

Compatibility with RoHS requirements

The product is compatible with the relevant clauses and requirements of the *RoHS directive 2011/65/EU* and *2015/863* have a maximum concentration value of 0.1% by weight in homogeneous materials for lead, mercury, hexavalent chromium, PBB, PBDE, DEHP, BBP, DBP, DIBP and of 0.01% by weight in homogeneous materials for cadmium.

Exemptions in the RoHS directive utilized in Flex Power Modules products are found in the Statement of Compliance document.

Flex Power Modules fulfills and will continuously fulfill all its obligations under regulation (EC) No 1907/2006 concerning the registration, evaluation, authorization and restriction of chemicals (REACH) as they enter into force and is through product materials declarations preparing for the obligations to communicate information on substances in the products.

Quality statement

The products are designed and manufactured in an industrial environment where quality systems and methods like [ISO 9001](#), [ISO 14001](#), [ISO 45001](#), *Six Sigma* and *SPC* are intensively in use to boost the continuous improvements strategy. Infant mortality or early failures in the products are screened out and they are subjected to an ATE-based final test. Conservative design rules, design reviews and product qualifications, plus the high competence of an engaged workforce, contribute to the high quality of the products.

Warranty

Warranty period and conditions are defined in *Flex Power Modules' General Terms and Conditions of Sales*.

Limitation of Liability

Flex Power Modules does not make any other warranties, expressed or implied including any warranty of merchantability or fitness for a particular purpose (including, but not limited to, use in life support applications, where malfunctions of product can cause injury to a person's health or life).

Product qualification specifications

Characteristics			
External visual inspection	IPC-A-610		
Temperature shock test (Temperature cycling)	IEC 60068-2-14 Na	Temperature range Number of cycles Dwell/transfer time	-40 to 125°C 700 15 min/0-1 min
Cold (in operation)	IEC 60068-2-1 Ad	Temperature T _A Duration	-45°C 72 h
Damp heat	IEC 60068-2-67 Cy	Temperature Humidity Duration	85°C 85% RH 1000 hours
Dry heat	IEC 60068-2-2 Bd	Temperature Duration	125°C 1000 h
Electrostatic discharge susceptibility	IEC 61340-3-1, JESD 22-A114 IEC 61340-3-2, JESD 22-A115	Human body model (HBM) Machine Model (MM)	Class 2, 2000 V Class 3, 200 V
Immersion in cleaning solvents	IEC 60068-2-45 XA, method 2	Water Flux Cleaner	55°C 23°C
Mechanical shock	IEC 60068-2-27 Ea	Peak acceleration Duration	100 g 6 ms
Moisture reflow sensitivity ¹	J-STD-020E	Level 1 (SnPb-eutectic) Level 3 (Pb Free)	225°C 245°C
Operational Life test Rapid Temp.	MIL-STD-202G, method 108A	Duration	1000 h
Resistance to soldering heat ²	IEC 60068-2-20 Tb, method 1A	Solder temperature Duration	270°C 10-13 s
Robustness of terminations	IEC 60068-2-21 Test Ua1 IEC 60068-2-21 Test Ue1	Through-hole mount products Surface-mount products	All leads All leads
Solderability	IEC 60068-2-20 test Ta	Preconditioning Temperature, Pb-free	Steam ageing 245°C
Vibration, broad band random	IEC 60068-2-64 Fh, method 1	Frequency Spectral density Duration	10 to 500 Hz 0.07 g ² /Hz 10 min in each direction

Note 1: only for products intended for reflow soldering (surface mount products & pin-in paste products)

Note 2: only for products intended for wave soldering (plated through hole products)

TECHNICAL REFERENCE DOCUMENT: SAFETY

Safety specifications

Flex Power Modules' DC/DC converters and DC/DC regulators are designed in accordance with the safety standards *IEC 62368-1*, *EN 62368-1* and *UL 62368-1 Audio/video, information and communication technology equipment - Part 1: Safety requirements*

IEC/EN/UL 62368-1 contains requirements to prevent injury or damage due to the following hazards:

- Electrical shock
- Electrically-caused fire
- Injury caused by hazardous substances
- Mechanically-caused injury
- Skin burn
- Radiation-caused injury

On-board DC/DC converters, Power Interface Modules and DC/DC regulators are defined as component power supplies. As components they cannot fully comply with the provisions of any safety requirements without "conditions of acceptability". Clearance between conductors and between conductive parts of the component power supply and conductors on the board in the final product must meet the applicable safety requirements. Certain conditions of acceptability apply for component power supplies with limited stand-off (please refer to *Technical Specification under Mechanical Information* for further information). It is the responsibility of the installer to ensure that the final product housing these components complies with the requirements of all applicable safety standards and regulations for the final product.

Component power supplies for general use shall comply with the requirements in *IEC/EN/UL 62368-1*. Product related standards, e.g. *IEEE 802.3af Power over Ethernet*, and *ETS-300132-2 Power interface at the input to telecom equipment, operated by direct current (dc)* are based on *IEC/EN/UL 62368-1* with regards to safety.

All Flex Power Modules' DC/DC converters, Power Interface Modules and DC/DC regulators are recognized and certified in accordance with *IEC/EN/UL 62368-1*. The flammability rating for all construction parts of the products meet requirements for V-1 class material according to "*IEC 60695-11-10 Fire hazard testing, test flames – 50 W horizontal and vertical flame test methods*".

Non-isolated DC/DC converters

The DC/DC converter output is ES1 energy source if the input source meets the requirements for ES1 according to *IEC/EN/UL 62368-1*.

TECHNICAL REFERENCE DOCUMENT: SOLDERING

Reflow soldering - surface mount

Products intended for surface mount assembly are qualified for use in a Pb-free forced convection or vapor phase reflow soldering process.

The reflow profile should be optimised to avoid excessive heating of the product. It is recommended to have a sufficiently extended preheat time to ensure an even temperature across the host PCB and it is also recommended to minimize the time in reflow.

A no-clean flux is recommended to avoid entrapment of cleaning fluids in cavities inside the product or between the product and the host board, since cleaning residues may affect long time reliability and isolation voltage.

General reflow process specification		Pb-free
Average temperature (T_{product})		3 °C/s max
Typical solder melting temp.	T_L	221 °C
Min. Reflow time above T_L	T_{pin}	60 s
Min. pin temp.	T_{pin}	235 °C
Peak product temp.	T_{product}	245 °C
Average ramp-down (T_{product})		6 °C/s max
Max. time 25° C to peak		8 minutes

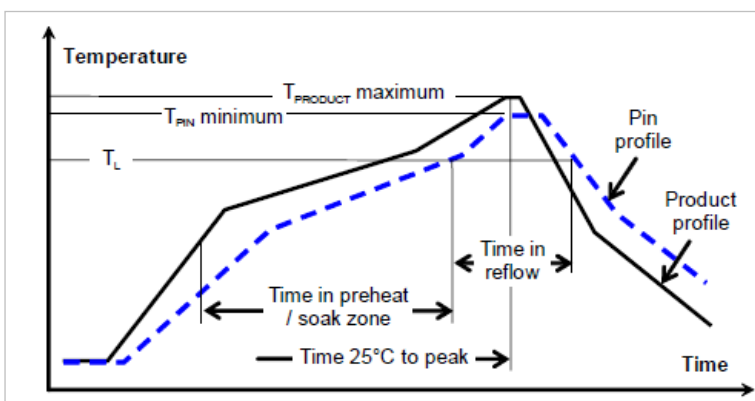

Typical soldering profile

For Pb-free solder processes, a pin temperature (T_{pin}) in excess of the solder melting temperature (T_L , 217 to 221°C for SnAgCu solder alloys) for more than 60 seconds and a peak temperature of 245 °C on all pins is recommended to ensure a reliable solder joint.

Thermocoupler attachment

T_{PRODUCT} is measured on the baseplate top side since this will likely be the warmest part of the product during the reflow process.

T_{PIN} temperature is measured on the power module output power pins solder joints at the customer board.

Product reflow classification

The product has been tested for the following:

Pb-free solder classification

For Pb-free solder processes, the product is qualified for MSL 3 according to IPC/JEDEC standard J-STD-020E.

Dry pack information

Products intended for Pb-free reflow soldering processes are delivered in standard moisture barrier bags according to IPC/JEDEC standard J-STD-033 (handling, packing, shipping and use of moisture/reflow sensitivity surface mount devices).

Using products in high temperature Pb-free soldering processes requires dry pack storage and handling. In case the products have been stored in an uncontrolled environment and no longer can be considered dry, floor life according to MSL 3, the modules must be baked according to J-STD-033.

Surface mount assembly and repair

The LGA of the product require particular care during assembly since the LGAs are hidden between the host board and the product's PCB. Special procedures are required for successful rework of these products.

Assembly

Automatic pick and place equipment should be used to mount the product on the host board. The use of a vision system, utilizing the fiducials on the bottom side of the product, will ensure adequate accuracy. Manual mounting of solder bump products is not recommended.

This module is not recommended for assembly on the bottom side of a customer board. If such an assembly is attempted, components may fall off the module during the second reflow process.

Repair

For a successful repair (removal and replacement) of an LGA product, a dedicated rework system should be used. The rework system should preferably utilize a reflow station and a bottom side heater might also be needed for the operation.

The product is a base plate design with a pick-up surface on a large central component (in this case the ferrite). However, use of this pick up surface for removal of the module when it's hot is not recommended. The best method is to use a tool to lift the module by its bottom PCB.

Technical Reference PMBus BMR3141011/001

This appendix contains a detailed reference of the PMBus commands supported by the product.

Data Formats

The products make use of a few standardized numerical formats, along with custom data formats. A detailed walkthrough of the above formats is provided in AN304, as well as in sections 7 and 8 of the PMBus Specification Part II. The custom data formats vary depending on the command, and are detailed in the command description.

Standard Commands

The functionality of commands with code 0x00 to 0xCF is usually based on the corresponding command specification provided in the PMBus Standard Specification Part II (see Power System Management Bus Protocol Documents below). However there might be different interpretations of the PMBus Standard Specification or only parts of the Standard Specification applied, thus the detailed command description below should always be consulted.

Forum Websites

The System Management Interface Forum (SMIF)

<http://www.powersig.org/>

The System Management Interface Forum (SMIF) supports the rapid advancement of an efficient and compatible technology base that promotes power management and systems technology implementations. The SMIF provides a membership path for any company or individual to be active participants in any or all of the various working groups established by the implementer forums.

Power Management Bus Implementers Forum
(PMBUS-IF)

<http://pmbus.org/>

The PMBus-IF supports the advancement and early adoption of the PMBus protocol for power management. This website offers recent PMBus specification documents, PMBus articles, as well as upcoming PMBus presentations and seminars, PMBus Document Review Board (DRB) meeting notes, and other PMBus related news.

PMBus – Power System Management Bus Protocol Documents

These specification documents may be obtained from the PMBus-IF website described above. These are required reading for complete understanding of the PMBus implementation. This appendix will not re-address all of the details contained within the two PMBus Specification documents.

Specification Part I – General Requirements Transport And Electrical Interface

Includes the general requirements, defines the transport and electrical interface and timing requirements of hard wired signals.

Specification Part II – Command Language

Describes the operation of commands, data formats, fault management and defines the command language used with the PMBus.

SMBus – System Management Bus Documents

System Management Bus Specification, Version 2.0, August 3, 2000

This specification specifies the version of the SMBus on which Revision 1.2 of the PMBus Specification is based. This specification is freely available from the System Management Interface Forum Web site at:

<http://www.smbus.org/specs/>

PMBus Command Summary and Factory Default Values of Standard Configuration

The factory default values provided in the table below are valid for the Standard configuration. Factory default values for other configurations can be found using the Flex Power Designer tool.

Code	Name	Data Format	Factory Default Value Standard Configuration BMR314X011/001 R1	Min Set Value	Max Set Value	Unit	
0x00	PAGE	R/W Byte	0x00				
0x01	OPERATION	R/W Byte					
0x02	ON_OFF_CONFIG	R/W Byte	0x17				
0x03	CLEAR_FAULTS	Send Byte					
0x10	WRITE_PROTECT	R/W Byte	0x00				
0x19	CAPABILITY	Read Byte	0x20				
0x20	VOUT_MODE	Read Byte	0x1B				
0x35	VIN_ON	R/W Word	0xE928	37.00	30	50	V
0x40	VOUT_OV_FAULT_LIMIT	R/W Word	0x0220	17.00	0	17	V
0x41	VOUT_OV_FAULT_RESPONSE	R/W Byte	0x80	0.00			ms
0x42	VOUT_OV_WARN_LIMIT	R/W Word	0x01F0	15.50	0	17	V
0x43	VOUT_UV_WARN_LIMIT	R/W Word	0x0110	8.50	0	15	V
0x44	VOUT_UV_FAULT_LIMIT	R/W Word	0x00F0	7.50	0	15	V
0x45	VOUT_UV_FAULT_RESPONSE	R/W Byte	0x80	0.00			ms
0x46	IOUT_OC_FAULT_LIMIT	R/W Word	0xF230	140.00	0	240	A
0x47	IOUT_OC_FAULT_RESPONSE	R/W Byte	0xC0	0.00			ms
0x4A	IOUT_OC_WARN_LIMIT	R/W Word	0xF168	90.00	0	150	A
0x4F	OT_FAULT_LIMIT	R/W Word	0x0078	120.00	25	130	°C
0x50	OT_FAULT_RESPONSE	R/W Byte	0x80	0.00			ms
0x51	OT_WARN_LIMIT	R/W Word	0x03FF	1023.00	25	1023	°C
0x55	VIN_OV_FAULT_LIMIT	R/W Word	0xEA20	68.00	0	68	V
0x56	VIN_OV_FAULT_RESPONSE	R/W Byte	0x80	0.00			ms
0x59	VIN_UV_FAULT_LIMIT	R/W Word	0xE900	32.00	0	50	V
0x5A	VIN_UV_FAULT_RESPONSE	R/W Byte	0x80	0.00			ms
0x68	POUT_OP_FAULT_LIMIT	R/W Word	0x1977	3000.00	0	3000	W
0x69	POUT_OP_FAULT_RESPONSE	R/W Byte	0x00	0.00			ms
0x6A	POUT_OP_WARN_LIMIT	R/W Word	0x1939	2504.00	0	3000	W
0x78	STATUS_BYTE	Read Byte					
0x79	STATUS_WORD	Read Word					
0x7A	STATUS_VOUT	Read Byte					
0x7B	STATUS_IOUT	Read Byte					
0x7C	STATUS_INPUT	Read Byte					
0x7D	STATUS_TEMPERATURE	Read Byte					
0x7E	STATUS_CML	Read Byte					
0x80	STATUS_MFR_SPECIFIC	Read Byte					
0x88	READ_VIN	Read Word					
0x8B	READ_VOUT	Read Word					
0x8C	READ_IOUT	Read Word					
0x8D	READ_TEMPERATURE_1	Read Word					
0x96	READ_POUT	Read Word					
0x98	PMBUS_REVISION	Read Byte	0x33				
0x99	MFR_ID	Read Block2	0x001A				
0x9A	MFR_MODEL	Read Block2	0x6000				
0x9B	MFR_REVISION	Read Block2	0x0002				
0x9D	MFR_DATE	Read Block2	Unit Specific				

0xB0	MFR_SPEC_SERIAL	Read Block4	Unit Specific					
0xB1	MFR_SPEC_MODEL_REV	Read Block8	Unit Specific					
0xC4	PASSW_I2C	Write Word						
0xC5	PASSW_OTP	Write Word						
0xC6	PASSW_ADDR	Write Word						
0xCF	OTP_WRITE	Read Byte						
0xD3	DEVICE_FULL_ADDRESS	Read Byte						
0xD4	DCX_VOUT_SS_FAULT	R/W Byte	0x05					
0xD5	MFR_IOUT_WARN_TIME	R/W Byte	0x43	73.70	2.2	280	ms	
0xD6	OTP_UPLOAD	R/W Byte						
0xD8	NTC_CS_LUT_STATUS	Read Byte	0x03					
0xD9	IMON_ITH1	R/W Word	0x0000	0.00				A
0xDA	IMON_GAIN_OVER_ITH1	R/W Byte	0x00					
0xDB	IMON_ITH2	R/W Word	0x0000	0.00				A
0xDC	IMON_GAIN_OVER_ITH2	R/W Byte	0x00					
0xDF	DCX_SS_PROTECTION	R/W Byte	0x0D	1.50				ms
0xE0	PMBUS_BASE_ADDRESS	R/W Byte	0xC0					
0xE1	NTC_LUT_CRC16_READ	Read Word	0x1A53					
0xE2	CS_LUT_CRC16_READ	Read Word	0x854F					
0xEE	CHECKSUM_CRC	Read Word	Unit Specific					
0xF0	REG_CON_OFFSET_IOUT	R/W Byte	Unit Specific					
0xF1	REG_CON_MULT_IOUT	R/W Byte	Unit Specific					

PMBus Command Details**PAGE (0x00)**

Description: Page command

Bit	Description	Format
7:0	Command for compability only, no function. Valid values are 0x00 and 0xFF.	Integer Unsigned

OPERATION (0x01)

Description: Sets the desired PMBus enable operation.

Bit	Description	Value	Function	Description
7:6	Make the device enable or disable if PMBus Enable has been activated in ON_OFF_CONFIG.	00	Immediate Off	Disable Immediately without sequencing.
		10	Enable	Enable device to the set voltage.

ON_OFF_CONFIG (0x02)

Description: Configures how the device is controlled by the EN pin and the PMBus OPERATION command. When entering PMBus enable mode (bit 3 changed from 0 to 1), OPERATION command changes to 0x00 and the output is turned off, if enabled. Thus, it is recommended that the output voltage is disabled when changing bit 3. If both bit 2 and bit 3 are set (enable by pin + by PMBus command) the enable pin must be active to allow control by OPERATION command. However, the enable pin can always control the output voltage regardless of the value of OPERATION command.

Bit	Function	Description	Value	Function	Description
4	Powerup Operation	Must be set to 1.	1	Enable pin or PMBus	Unit does not power up until commanded by the CONTROL pin and OPERATION command.
3	PMBus Enable Mode	Controls how the unit responds to commands received via the serial bus.	0	Ignore PMBus	Unit ignores the on/off portion of the OPERATION command from serial bus.
			1	Use PMBus	To start, the unit requires that the on/off portion of the OPERATION command is instructing the unit to run.
2	Enable Pin Mode	Controls how the unit responds to the CONTROL pin.	0	Ignore pin	Unit ignores the CONTROL/Enable pin.
			1	Use pin	Unit requires the CONTROL pin to be asserted to start the unit.
1	Enable Pin Polarity	Polarity of the CONTROL pin.	1	Active High	Enable pin will cause device to enable when driven high.
			0	Active Low	Enable pin will cause device to enable when driven low.
0	Disable Action	Must be set to 1.	1	Imm. Off	Turn off the output and stop transferring energy to the output as fast as possible.

CLEAR_FAULTS (0x03)

Description: Clears all fault status bits

WRITE_PROTECT (0x10)

Description: The WRITE_PROTECT command is used to control writing to the PMBus device. The intent of this command is to provide protection against accidental changes. This command is not intended to provide protection against deliberate or malicious changes to a device's configuration or operation. Above what is specified in the PMBus standard the following protection modes are available: Data 0000 0011 => Disable all writes

Bit	Description	Value	Function	Description
7:0	All supported commands may have their parameters read, regardless of the WRITE_PROTECT settings.	0x80	Enable write command	Disable all writes except to the WRITE_PROTECT command.
		0x40	Enable operation	Disable all writes except to the WRITE_PROTECT, OPERATION and PAGE commands.
		0x20	Enable control and Vout commands	Disable all writes except to the WRITE_PROTECT, OPERATION, PAGE, ON_OFF_CONFIG and VOUT_COMMAND commands.
		0x03	Disable all writes	Disable all writes. Deadlock - needs a recycle of input voltage to unlock.
		0x02	Enable Vout command	Disable all writes except to the VOUT_COMMAND command. Deadlock - needs a recycle of input voltage to unlock.
		0x00	Enable all commands	Enable writes to all commands.

CAPABILITY (0x19)

Description: This command provides a way for a host system to determine some key capabilities of a PMBus device.

Bit	Function	Description	Value	Function	Description
7	Packet Error Checking	Packet error checking.	00	Not Supported	Packet Error Checking not supported.
			01	Supported	Packet Error Checking is supported.
6:5	Maximum Bus Speed	Maximum bus speed.	00	100kHz	Maximum supported bus speed is 100 kHz.
			01	400kHz	Maximum supported bus speed is 400 kHz.
			10	1MHz	Maximum supported bus speed is 1 MHz.
4	Smbalert	SMBALERT	00	No Smbalert	The device does not have a SMBALERT# pin and does not support the SMBus Alert Response protocol.
			01	Have Smbalert	The device does have a SMBALERT# pin and does support the SMBus Alert Response protocol.
3	Numeric Format	Numeric format.	0	LINEAR or DIRECT Format	Numeric data is in LINEAR or DIRECT format.

			1	IEEE Half Precision Floating Point Format	Numeric data is in IEEE half precision floating point format.
2	AVSBus Support	AVSBus support.	0	AVSBus Not Supported	AVSBus not supported.
			1	AVSBus Supported	AVSBus supported.

VOUT_MODE (0x20)

Description: Controls how future VOUT-related commands parameters will be interpreted.

Bit	Function	Description	Format
4:0		Five bit two's complement EXPONENT for the MANTISSA delivered as the data bytes for VOUT_COMMAND in VOUT_LINEAR Mode, five bit VID code identifier per in VID Mode or always set to 00000b in Direct Mode.	Integer Signed

Bit	Function	Description	Value	Function	Description
7:5		Set to 000b to select VOUT_LINEAR Mode (Five bit two's complement exponent for the MANTISSA delivered as the data bytes for an output voltage related command), set to 001b to select VID Mode (Five bit VID code identifier per) or set to 010b to select Direct Mode (Always set to 00000b).	000	Linear	Linear Mode Format.
			001	VID	VID Mode.
			010	Direct	Direct Mode.

VIN_ON (0x35)

Description: The VIN_ON command sets the value of the input voltage, in volts, at which the unit should start power conversion.

Bit	Description	Format	Unit
15:0	Sets the VIN ON threshold. Linear exponent must be set to -3.	Linear	V

VOUT_OV_FAULT_LIMIT (0x40)

Description: Output over voltage fault limit.

Bit	Description	Format	Unit
15:0	Output over voltage fault limit.	Vout Mode Unsigned (Exp = -5)	V

VOUT_OV_FAULT_RESPONSE (0x41)

Description: Output over voltage fault response.

Bit	Function	Description	Format	Unit
2:0	Retry Time and Delay Time	Delay time in 200 ms units between attempts to restart.	Fixed Point Unsigned	ms

Bit	Function	Description	Value	Function	Description
-----	----------	-------------	-------	----------	-------------

7:6	Response	Describes the device interruption operation. 00b - The PMBus device continues operation without interruption. 10b - The device shuts down (disables the output) and responds according to the Retry Setting in bits [5:3].	00	Ignore Fault	The PMBus device continues operation without interruption.
			10	Disable and retry	The device shuts down (disables the output) and responds according to the retry setting in bits [5:3].
5:3	Retries	The device attempts to restart the number of times set by these bits. 000b means the device does not attempt a restart. 111b means the device attempts restarting continuously.	000	Do Not Retry	A zero value for the Retry Setting means that the unit does not attempt to restart. The output remains disabled until the fault is cleared (Section 10.7).
			001	Retry Once	The PMBus device attempts to restart 1 time. If the device fails to restart, it disables the output and remains off until the fault is cleared as described in Section 10.7. The time between the start of each attempt to restart is set by the value in bits [2:] along with the delay time unit specified for that particular fault.
			010	Retry Twice	The PMBus device attempts to restart 2 times. If the device fails to restart, it disables the output and remains off until the fault is cleared as described in Section 10.7. The time between the start of each attempt to restart is set by the value in bits [2:] along with the delay time unit specified for that particular fault.
			011	Retry 3 times	The PMBus device attempts to restart 3 times. If the device fails to restart, it disables the output and remains off until the fault is cleared as described in Section 10.7. The time between the start of each attempt to restart is set by the value in bits [2:] along with the delay time unit specified for that particular fault.

			100	Retry 4 times	The PMBus device attempts to restart 4 times. If the device fails to restart, it disables the output and remains off until the fault is cleared as described in Section 10.7. The time between the start of each attempt to restart is set by the value in bits [2:] along with the delay time unit specified for that particular fault.
			101	Retry 5 times	The PMBus device attempts to restart 5 times. If the device fails to restart, it disables the output and remains off until the fault is cleared as described in Section 10.7. The time between the start of each attempt to restart is set by the value in bits [2:] along with the delay time unit specified for that particular fault.
			110	Retry 6 times	The PMBus device attempts to restart 6 times. If the device fails to restart, it disables the output and remains off until the fault is cleared as described in Section 10.7. The time between the start of each attempt to restart is set by the value in bits [2:] along with the delay time unit specified for that particular fault.
			111	Retry Continuously	The PMBus device attempts to restart continuously, without limitation, until it is commanded OFF (by the CONTROL pin or OPERATION command or both), bias power is removed, or another fault condition causes the unit to shut down.

VOUT_OV_WARN_LIMIT (0x42)

Description: Output over voltage warning limit.

Bit	Description	Format	Unit
15:0	Output over voltage warning limit.	Vout Mode Unsigned (Exp = -5)	V

VOUT_UV_WARN_LIMIT (0x43)

Description: Output under voltage warning limit.

Bit	Description	Format	Unit
15:0	Output under voltage warning limit.	Vout Mode Unsigned (Exp = -5)	V

VOUT_UV_FAULT_LIMIT (0x44)

Description: Output under voltage fault limit.

Bit	Description	Format	Unit
15:0	Output under voltage fault limit.	Vout Mode Unsigned (Exp = -5)	V

VOUT_UV_FAULT_RESPONSE (0x45)

Description: Output under voltage fault response.

Bit	Function	Description	Format	Unit
2:0	Retry Time and Delay Time	Delay time in 200 ms units between attempts to restart.	Fixed Point Unsigned	ms

Bit	Function	Description	Value	Function	Description
7:6	Response	Describes the device interruption operation. 00b - The PMBus device continues operation without interruption. 10b - The device shuts down (disables the output) and responds according to the Retry Setting in bits [5:3].	00	Ignore Fault	The PMBus device continues operation without interruption.
			10	Disable and retry	The device shuts down (disables the output) and responds according to the retry setting in bits [5:3].
5:3	Retries	The device attempts to restart the number of times set by these bits. 000b means the device does not attempt a restart. 111b means the device attempts restarting continuously.	000	Do Not Retry	A zero value for the Retry Setting means that the unit does not attempt to restart. The output remains disabled until the fault is cleared (Section 10.7).
			001	Retry Once	The PMBus device attempts to restart 1 time. If the device fails to restart, it disables the output and remains off until the fault is cleared as described in Section 10.7. The time between the start of each attempt to restart is set by the value in bits [2:] along with the delay time unit specified for that particular fault.

			010	Retry Twice	The PMBus device attempts to restart 2 times. If the device fails to restart, it disables the output and remains off until the fault is cleared as described in Section 10.7. The time between the start of each attempt to restart is set by the value in bits [2:] along with the delay time unit specified for that particular fault.
			011	Retry 3 times	The PMBus device attempts to restart 3 times. If the device fails to restart, it disables the output and remains off until the fault is cleared as described in Section 10.7. The time between the start of each attempt to restart is set by the value in bits [2:] along with the delay time unit specified for that particular fault.
			100	Retry 4 times	The PMBus device attempts to restart 4 times. If the device fails to restart, it disables the output and remains off until the fault is cleared as described in Section 10.7. The time between the start of each attempt to restart is set by the value in bits [2:] along with the delay time unit specified for that particular fault.
			101	Retry 5 times	The PMBus device attempts to restart 5 times. If the device fails to restart, it disables the output and remains off until the fault is cleared as described in Section 10.7. The time between the start of each attempt to restart is set by the value in bits [2:] along with the delay time unit specified for that particular fault.

			110	Retry 6 times	The PMBus device attempts to restart 6 times. If the device fails to restart, it disables the output and remains off until the fault is cleared as described in Section 10.7. The time between the start of each attempt to restart is set by the value in bits [2:] along with the delay time unit specified for that particular fault.
			111	Retry Continuously	The PMBus device attempts to restart continuously, without limitation, until it is commanded OFF (by the CONTROL pin or OPERATION command or both), bias power is removed, or another fault condition causes the unit to shut down.

IOUT_OC_FAULT_LIMIT (0x46)

Description: Output over current limit.

Bit	Description	Format	Unit
15:0	Output over current fault limit. Linear exponent must be -2.	Linear	A

IOUT_OC_FAULT_RESPONSE (0x47)

Description: Output over current fault response.

Bit	Function	Description	Format	Unit
2:0	Retry Time and Delay Time	Delay time in 200 ms units between attempts to restart.	Fixed Point Unsigned	ms

Bit	Function	Description	Value	Function	Description
7:6	Response	For all values of bits [7:6], the device: Sets the corresponding fault bit in the status registers and If the device supports notifying the host, it does so.	00	Ignore Fault	The PMBus device continues to operate indefinitely while maintaining the output current at the value set by IOUT_OC_FAULT_LIMIT without regard to the output voltage (known as constant-current or brickwall limiting).
			11	Disable and Retry	The device shuts down (disables the output) and responds according to the retry setting in bits [5:3].
5:3	Retries		000	Do Not Retry	A zero value for the Retry Setting means that the unit does not attempt to restart. The output remains disabled until the fault is cleared (Section 10.7).

		The device attempts to restart the number of times set by these bits. 000b means the device does not attempt a restart. 111b means the device attempts restarting continuously.	001	Retry Once	The PMBus device attempts to restart 1 time. If the device fails to restart, it disables the output and remains off until the fault is cleared as described in Section 10.7. The time between the start of each attempt to restart is set by the value in bits [2:] along with the delay time unit specified for that particular fault.
			010	Retry Twice	The PMBus device attempts to restart 2 times. If the device fails to restart, it disables the output and remains off until the fault is cleared as described in Section 10.7. The time between the start of each attempt to restart is set by the value in bits [2:] along with the delay time unit specified for that particular fault.
			011	Retry 3 times	The PMBus device attempts to restart 3 times. If the device fails to restart, it disables the output and remains off until the fault is cleared as described in Section 10.7. The time between the start of each attempt to restart is set by the value in bits [2:] along with the delay time unit specified for that particular fault.
			100	Retry 4 times	The PMBus device attempts to restart 4 times. If the device fails to restart, it disables the output and remains off until the fault is cleared as described in Section 10.7. The time between the start of each attempt to restart is set by the value in bits [2:] along with the delay time unit specified for that particular fault.

			101	Retry 5 times	The PMBus device attempts to restart 5 times. If the device fails to restart, it disables the output and remains off until the fault is cleared as described in Section 10.7. The time between the start of each attempt to restart is set by the value in bits [2:] along with the delay time unit specified for that particular fault.
			110	Retry 6 times	The PMBus device attempts to restart 6 times. If the device fails to restart, it disables the output and remains off until the fault is cleared as described in Section 10.7. The time between the start of each attempt to restart is set by the value in bits [2:] along with the delay time unit specified for that particular fault.
			111	Retry Continuously	The PMBus device attempts to restart continuously, without limitation, until it is commanded OFF (by the CONTROL pin or OPERATION command or both), bias power is removed, or another fault condition causes the unit to shut down.

IOUT_OC_WARN_LIMIT (0x4A)

Description: Output over current warning limit.

Bit	Description	Format	Unit
15:0	Output over current warning limit. Linear exponent must be set to -2.	Linear	A

OT_FAULT_LIMIT (0x4F)

Description: Over temperature fault limit.

Bit	Description	Format	Unit
15:0	Over temperature fault limit. Linear exponent must be set to 0.	Linear	°C

OT_FAULT_RESPONSE (0x50)

Description: Over temperature fault response.

Bit	Function	Description	Format	Unit
2:0	Retry Time and Delay Time	Delay time in 200 ms units between attempts to restart.	Fixed Point Unsigned	ms

Bit	Function	Description	Value	Function	Description
-----	----------	-------------	-------	----------	-------------

7:6	Response		00	Ignore Fault	The PMBus device continues operation without interruption.
			10	Disable and retry	The device shuts down (disables the output) and responds according to the retry setting in bits [5:3].
5:3	Retries		000	Do Not Retry	A zero value for the Retry Setting means that the unit does not attempt to restart. The output remains disabled until the fault is cleared (Section 10.7).
			001	Retry Once	The PMBus device attempts to restart 1 time. If the device fails to restart, it disables the output and remains off until the fault is cleared as described in Section 10.7. The time between the start of each attempt to restart is set by the value in bits [2:] along with the delay time unit specified for that particular fault.
			010	Retry Twice	The PMBus device attempts to restart 2 times. If the device fails to restart, it disables the output and remains off until the fault is cleared as described in Section 10.7. The time between the start of each attempt to restart is set by the value in bits [2:] along with the delay time unit specified for that particular fault.
			011	Retry 3 times	The PMBus device attempts to restart 3 times. If the device fails to restart, it disables the output and remains off until the fault is cleared as described in Section 10.7. The time between the start of each attempt to restart is set by the value in bits [2:] along with the delay time unit specified for that particular fault.

			100	Retry 4 times	The PMBus device attempts to restart 4 times. If the device fails to restart, it disables the output and remains off until the fault is cleared as described in Section 10.7. The time between the start of each attempt to restart is set by the value in bits [2:] along with the delay time unit specified for that particular fault.
			101	Retry 5 times	The PMBus device attempts to restart 5 times. If the device fails to restart, it disables the output and remains off until the fault is cleared as described in Section 10.7. The time between the start of each attempt to restart is set by the value in bits [2:] along with the delay time unit specified for that particular fault.
			110	Retry 6 times	The PMBus device attempts to restart 6 times. If the device fails to restart, it disables the output and remains off until the fault is cleared as described in Section 10.7. The time between the start of each attempt to restart is set by the value in bits [2:] along with the delay time unit specified for that particular fault.
			111	Retry Continuously	The PMBus device attempts to restart continuously, without limitation, until it is commanded OFF (by the CONTROL pin or OPERATION command or both), bias power is removed, or another fault condition causes the unit to shut down.

OT_WARN_LIMIT (0x51)

Description: Over temperature warning limit.

Bit	Description	Format	Unit
15:0	Over temperature warning limit. Linear exponent must be set to 0.	Linear	°C

VIN_OV_FAULT_LIMIT (0x55)

Description: Input over voltage fault limit.

Bit	Description	Format	Unit
-----	-------------	--------	------

15:0	Input over voltage fault limit. Linear exponent must be set to -3.	Linear	V
------	--	--------	---

VIN_OV_FAULT_RESPONSE (0x56)

Description: Input over voltage fault response.

Bit	Function	Description	Format	Unit
2:0	Retry Time and Delay Time	Delay time in 200 ms units between attempts to restart.	Fixed Point Unsigned	ms

Bit	Function	Description	Value	Function	Description
7:6	Response		00	Ignore Fault	The PMBus device continues operation without interruption.
			10	Disable and retry	The device shuts down (disables the output) and responds according to the retry setting in bits [5:3].
5:3	Retries		000	Do Not Retry	A zero value for the Retry Setting means that the unit does not attempt to restart. The output remains disabled until the fault is cleared (Section 10.7).
			001	Retry Once	The PMBus device attempts to restart 1 time. If the device fails to restart, it disables the output and remains off until the fault is cleared as described in Section 10.7. The time between the start of each attempt to restart is set by the value in bits [2:] along with the delay time unit specified for that particular fault.
			010	Retry Twice	The PMBus device attempts to restart 2 times. If the device fails to restart, it disables the output and remains off until the fault is cleared as described in Section 10.7. The time between the start of each attempt to restart is set by the value in bits [2:] along with the delay time unit specified for that particular fault.

			011	Retry 3 times	The PMBus device attempts to restart 3 times. If the device fails to restart, it disables the output and remains off until the fault is cleared as described in Section 10.7. The time between the start of each attempt to restart is set by the value in bits [2:] along with the delay time unit specified for that particular fault.
			100	Retry 4 times	The PMBus device attempts to restart 4 times. If the device fails to restart, it disables the output and remains off until the fault is cleared as described in Section 10.7. The time between the start of each attempt to restart is set by the value in bits [2:] along with the delay time unit specified for that particular fault.
			101	Retry 5 times	The PMBus device attempts to restart 5 times. If the device fails to restart, it disables the output and remains off until the fault is cleared as described in Section 10.7. The time between the start of each attempt to restart is set by the value in bits [2:] along with the delay time unit specified for that particular fault.
			110	Retry 6 times	The PMBus device attempts to restart 6 times. If the device fails to restart, it disables the output and remains off until the fault is cleared as described in Section 10.7. The time between the start of each attempt to restart is set by the value in bits [2:] along with the delay time unit specified for that particular fault.
			111	Retry Continuously	The PMBus device attempts to restart continuously, without limitation, until it is commanded OFF (by the CONTROL pin or OPERATION command or both), bias power is removed, or another fault condition causes the unit to shut down.

VIN_UV_FAULT_LIMIT (0x59)

Description: Input under voltage fault limit.

Bit	Description	Format	Unit
15:0	Input under voltage fault limit. Linear exponent must be set to -3.	Linear	V

VIN_UV_FAULT_RESPONSE (0x5A)

Description: Input under voltage fault response.

Bit	Function	Description	Format	Unit
2:0	Retry Time and Delay Time	Delay time in 200 ms units between attempts to restart.	Fixed Point Unsigned	ms

Bit	Function	Description	Value	Function	Description
7:6	Response		00	Ignore Fault	The PMBus device continues operation without interruption.
			10	Disable and retry	The device shuts down (disables the output) and responds according to the retry setting in bits [5:3].
5:3	Retries		000	Do Not Retry	A zero value for the Retry Setting means that the unit does not attempt to restart. The output remains disabled until the fault is cleared (Section 10.7).
			001	Retry Once	The PMBus device attempts to restart 1 time. If the device fails to restart, it disables the output and remains off until the fault is cleared as described in Section 10.7. The time between the start of each attempt to restart is set by the value in bits [2:] along with the delay time unit specified for that particular fault.
			010	Retry Twice	The PMBus device attempts to restart 2 times. If the device fails to restart, it disables the output and remains off until the fault is cleared as described in Section 10.7. The time between the start of each attempt to restart is set by the value in bits [2:] along with the delay time unit specified for that particular fault.

			011	Retry 3 times	The PMBus device attempts to restart 3 times. If the device fails to restart, it disables the output and remains off until the fault is cleared as described in Section 10.7. The time between the start of each attempt to restart is set by the value in bits [2:] along with the delay time unit specified for that particular fault.
			100	Retry 4 times	The PMBus device attempts to restart 4 times. If the device fails to restart, it disables the output and remains off until the fault is cleared as described in Section 10.7. The time between the start of each attempt to restart is set by the value in bits [2:] along with the delay time unit specified for that particular fault.
			101	Retry 5 times	The PMBus device attempts to restart 5 times. If the device fails to restart, it disables the output and remains off until the fault is cleared as described in Section 10.7. The time between the start of each attempt to restart is set by the value in bits [2:] along with the delay time unit specified for that particular fault.
			110	Retry 6 times	The PMBus device attempts to restart 6 times. If the device fails to restart, it disables the output and remains off until the fault is cleared as described in Section 10.7. The time between the start of each attempt to restart is set by the value in bits [2:] along with the delay time unit specified for that particular fault.
			111	Retry Continuously	The PMBus device attempts to restart continuously, without limitation, until it is commanded OFF (by the CONTROL pin or OPERATION command or both), bias power is removed, or another fault condition causes the unit to shut down.

POUT_OP_FAULT_LIMIT (0x68)

Description: Sets the Output power over-power fault limit.

Bit	Description	Format	Unit
15:0	Output power over-power fault limit. Linear exponent must be set to 3.	Linear	W

POUT_OP_FAULT_RESPONSE (0x69)

Description: Sets the output power Over-Power fault response.

Bit	Function	Description	Format	Unit
2:0	Retry Time and Delay Time	Delay time in 200 ms units between attempts to restart.	Fixed Point Unsigned	ms

Bit	Function	Description	Value	Function	Description
7:6	Response		00	Ignore Fault	The PMBus device continues operation without interruption.
			10	Disable and retry	The device shuts down (disables the output) and responds according to the retry setting in bits [5:3].
5:3	Retries		000	Do Not Retry	A zero value for the Retry Setting means that the unit does not attempt to restart. The output remains disabled until the fault is cleared (Section 10.7).
			001	Retry Once	The PMBus device attempts to restart 1 time. If the device fails to restart, it disables the output and remains off until the fault is cleared as described in Section 10.7. The time between the start of each attempt to restart is set by the value in bits [2:] along with the delay time unit specified for that particular fault.
			010	Retry Twice	The PMBus device attempts to restart 2 times. If the device fails to restart, it disables the output and remains off until the fault is cleared as described in Section 10.7. The time between the start of each attempt to restart is set by the value in bits [2:] along with the delay time unit specified for that particular fault.

			011	Retry 3 times	The PMBus device attempts to restart 3 times. If the device fails to restart, it disables the output and remains off until the fault is cleared as described in Section 10.7. The time between the start of each attempt to restart is set by the value in bits [2:] along with the delay time unit specified for that particular fault.
			100	Retry 4 times	The PMBus device attempts to restart 4 times. If the device fails to restart, it disables the output and remains off until the fault is cleared as described in Section 10.7. The time between the start of each attempt to restart is set by the value in bits [2:] along with the delay time unit specified for that particular fault.
			101	Retry 5 times	The PMBus device attempts to restart 5 times. If the device fails to restart, it disables the output and remains off until the fault is cleared as described in Section 10.7. The time between the start of each attempt to restart is set by the value in bits [2:] along with the delay time unit specified for that particular fault.
			110	Retry 6 times	The PMBus device attempts to restart 6 times. If the device fails to restart, it disables the output and remains off until the fault is cleared as described in Section 10.7. The time between the start of each attempt to restart is set by the value in bits [2:] along with the delay time unit specified for that particular fault.
			111	Retry Continuously	The PMBus device attempts to restart continuously, without limitation, until it is commanded OFF (by the CONTROL pin or OPERATION command or both), bias power is removed, or another fault condition causes the unit to shut down.

POUT_OP_WARN_LIMIT (0x6A)

Description: Sets the Output power over-power warn limit.

Bit	Description	Format	Unit
15:0	Output power over-power warn limit. Linear exponent must be set to 3.	Linear	W

STATUS_BYTE (0x78)

Description: Returns a brief fault/warning status byte.

Bit	Function	Description	Value	Description
6	Off	This bit is asserted if the unit is not providing power to the output, regardless of the reason, including simply not being enabled.	0	No fault
			1	Fault
5	Vout Overvoltage Fault	An output overvoltage fault has occurred.	0	No fault
			1	Fault
4	Iout Overcurrent Fault	An output overcurrent fault has occurred.	0	No fault
			1	Fault
3	Vin Undervoltage Fault	An input undervoltage fault has occurred.	0	No fault
			1	Fault
2	Temperature	A temperature fault or warning has occurred.	0	No fault
			1	Fault
1	Communication/Logic	A communications, memory or logic fault has occurred.	0	No fault
			1	Fault
0	None of the Above	A fault or warning not listed in bits [7:1] has occurred.	0	No fault
			1	Fault

STATUS_WORD (0x79)

Description: Returns an extended fault/warning status byte.

Bit	Function	Description	Value	Description
15	Vout	An output voltage fault or warning has occurred.	0	No fault
			1	Fault
14	Iout/Pout	An output current or output power fault or warning has occurred.	0	No Fault.
			1	Fault.
13	Input	An input voltage, input current, or input power fault or warning has occurred.	0	No Fault.
			1	Fault.
12	Mfr Specific	A manufacturer specific fault or warning has occurred.	0	No Fault.
			1	Fault.
11	Power-Good	The Power-Good signal, if present, is negated.	0	No Fault.
			1	Fault.
6	Off	This bit is asserted if the unit is not providing power to the output, regardless of the reason, including simply not being enabled.	0	No fault
			1	Fault
5	Vout Overvoltage Fault	An output overvoltage fault has occurred.	0	No Fault.
			1	Fault.
4	Iout Overcurrent Fault	An output overcurrent fault has occurred.	0	No Fault.
			1	Fault.
3	Vin Undervoltage Fault	An input undervoltage fault has occurred.	0	No Fault.
			1	Fault.
2	Temperature	A temperature fault or warning has occurred.	0	No Fault.
			1	Fault.
1	Communication/Logic	A communications, memory or logic fault has occurred.	0	No fault.
			1	Fault.
0	None of the Above		0	No fault.

		A fault or warning not listed in bits [7:1] has occurred.	1	Fault.
--	--	---	---	--------

STATUS_VOUT (0x7A)

Description: Returns Vout-related fault/warning status bits.

Bit	Function	Description	Value	Description
7	Vout Overvoltage Fault	Vout Overvoltage Fault.	0	No Fault.
			1	Fault.
6	Vout Overvoltage Warning	Vout Overvoltage Warning.	0	No Warning.
			1	Warning.
5	Vout Undervoltage Warning	Vout Undervoltage Warning.	0	No Warning.
			1	Warning.
4	Vout Undervoltage Fault	Vout Undervoltage Fault.	0	No Fault.
			1	Fault.

STATUS_IOUT (0x7B)

Description: Returns Iout-related fault/warning status bits.

Bit	Function	Description	Value	Description
7	Iout Overcurrent Fault	Iout Overcurrent Fault.	0	No Fault.
			1	Fault.
5	Iout Over Current Warning	Iout Overcurrent Warning.	0	No Warning.
			1	Warning.
1	Pout Over Power Fault	Pout Over Power Fault.	0	No Fault.
			1	Fault.
0	Pout Over Power Warning	Pout Over Power Warning.	0	No Warning.
			1	Warning.

STATUS_INPUT (0x7C)

Description: Returns VIN/IIN-related fault/warning status bits.

Bit	Function	Description	Value	Description
7	Vin Overvoltage Fault	Vin Overvoltage Fault.	0	No Fault.
			1	Fault.
6	Vin Overvoltage Warning	VIN Overvoltage Warning.	0	No Warning.
			1	Warning.
5	Vin Undervoltage Warning	Vin Undervoltage Warning.	0	No Warning.
			1	Warning.
4	Vin Undervoltage Fault	Vin Undervoltage Fault.	0	No Fault.
			1	Fault.
3	Insufficient Vin	Asserted when either the input voltage has never exceeded the input turn-on threshold Vin-On, or if the unit did start, the input voltage decreased below the turn-off threshold.	0	No Insufficient VIN encountered yet.
			1	Insufficient Unit is off.

STATUS_TEMPERATURE (0x7D)

Description: Returns the temperature-related fault/warning status bits.

Bit	Function	Description	Value	Description
7	Overtemperature Fault	Overtemperature Fault.	0	No Fault.
			1	Fault.
6	Overtemperature Warning	Overtemperature Warning.	0	No Warning.
			1	Warning.

STATUS_CML (0x7E)

Description: Returns Communication/Logic/Memory-related fault/warning status bits.

Bit	Function	Description	Value	Description
7	Invalid or Unsupported Command Received	Invalid or Unsupported Command Received.	0	No Invalid Command Received.
			1	Invalid Command Received.
6	Invalid or Unsupported Data Received	Invalid or Unsupported Data Received.	0	No Invalid Data Received.
			1	Invalid Data Received.
5	Packet Error Check Failed	Packet Error Check Failed.	0	No Failure.
			1	Failure.
4	Memory Fault Detected	Memory Fault Detected.	0	No Fault.
			1	Fault.

STATUS_MFR_SPECIFIC (0x80)

Description: Returns manufacturer specific status information.

Bit	Function	Description	Value	Description
7	Analog Ratio Protection	Analog Ratio Protection.	0	No Fault.
			1	Fault.
6	Digital Ratio Protection	Digital Ratio Protection; $N * V_{out} - V_{INSS}$.	0	No Fault.
			1	Fault.
5	Buck Duty Fault	Buck duty fault; $ V_{BUS} - V_{INSS} < K * V_{INSS}$.	0	No Fault.
			1	Fault.
4	Analog (peak) OC Protection	Analog (peak) OC protection.	0	No Fault.
			1	Fault.
2	Vout Monotonic Rise Fault	Vout rise is not monotonic at startup, i.e. short circuit on output.	0	No Fault.
			1	Fault.
1	VCC Boot Below Threshold	At the start-up, the VCC was below threshold.	0	No Fault.
			1	Fault.
0	Vout Boot Below Threshold	At the start-up, the VOUT was below threshold.	0	No Fault.
			1	Fault.

READ_VIN (0x88)

Description: Returns the measured input voltage.

Bit	Description	Format	Unit
15:0	Returns the input voltage reading.	Linear	V

READ_VOUT (0x8B)

Description: Returns the measured output voltage.

Bit	Description	Format	Unit
15:0	Returns the measured output voltage.	Vout Mode Unsigned (Exp = -5)	V

READ_IOUT (0x8C)

Description: Returns the measured output current.

Bit	Description	Format	Unit
15:0	Returns the measured output current.	Linear	A

READ_TEMPERATURE_1 (0x8D)

Description: Reads temperature from the internal sensor.

Bit	Description	Format	Unit
15:0		Linear	°C

READ_POUT (0x96)

Description: Returns the calculated output power.

Bit	Description	Format	Unit
15:0		Linear	W

PMBUS_REVISION (0x98)

Description: Returns the PMBus revision number for this device.

Bit	Function	Description	Value	Function	Description
7:4	Part I Revision	Part I Revision.	0x0	1.0	Part I Revision 1.0.
			0x1	1.1	Part I Revision 1.1.
			0x2	1.2	Part I Revision 1.2.
			0x3	1.3	Part I Revision 1.3.
3:0	Part II Revision	Part II Revision.	0x0	1.0	Part II Revision 1.0.
			0x1	1.1	Part II Revision 1.1.
			0x2	1.2	Part II Revision 1.2.
			0x3	1.3	Part II Revision 1.3.

MFR_ID (0x99)

Description: Sets the Manufacturers ID

Bit	Description	Format
15:0	Manufacturer ID.	Integer Unsigned

MFR_MODEL (0x9A)

Description: Mfr. Model

Bit	Description	Format
15:0	Mfr. Model.	ASCII

MFR_REVISION (0x9B)

Description: Sets the MFR revision string.

Bit	Description	Format
15:0	Mfr. Revision.	Integer Unsigned

MFR_DATE (0x9D)

Description: This command returns the date the regulator was manufactured.

Bit	Function	Description	Format
15:8	Mfr. Week	The week number.	Integer Unsigned
7:0	Mfr. Year	The year (e.g. 20 stands for 2020).	Integer Unsigned

MFR_SPEC_SERIAL (0xB0)

Description: Contains serial # from production.

Bit	Function	Description	Format
-----	----------	-------------	--------

31:27	Test station number	Test station number, e.g. 00000 = X01	Integer Unsigned
26:0	Serial number	Serial number. Decimal number calculated as: 100000 x (Last three digits of production order number) + counter number	Integer Unsigned

MFR_SPEC_MODEL_REV (0xB1)

Description: Contains product number and revision information.

Bit	Function	Description	Format
63	Scheme ID	Always 1	Integer Unsigned
59:50	BMR number 3-digit	Number 0-999.	Integer Unsigned
49:46	BMR number 1-digit	Number 0-9.	Integer Unsigned
45:42	BMR number 1-digit	Number 0-9.	Integer Unsigned
41:38	BMR number 1-digit	Number 0-9.	Integer Unsigned
37:34	BMR number 1-digit	Number 0-9.	Integer Unsigned
33:24	BMR number after /	Number 0-999.	Integer Unsigned
22:17	Product revision number	Number 1-63.	Integer Unsigned
16:12	Product revision letter	Number 1-26 represents A-Z.	Integer Unsigned
10:6	Config revision letter	Number 1-26 represents A-Z.	Integer Unsigned
5:0	Config revision number	Number 1-63. Ignore for sharp release.	Integer Unsigned

Bit	Function	Description	Value	Description
23	Product preliminary revision	0=Sharp revision (e.g. R1A), 1=Preliminary revision (e.g. P1A)	0	Sharp revision (e.g. R1A)
			1	Preliminary revision (e.g. P1A)
11	Config preliminary revision	0=Sharp revision, 1=Preliminary revision	0	Sharp revision
			1	Preliminary revision

PASSW_I2C (0xC4)

Description: Password for I2C

Bit	Description	Format
15:0	Write value 0xC93F to this command to enable I2C register writes. Writing the password to this command is also required for passwords in 0xC5 and 0xC6 to be effective.	Byte Array

PASSW_OTP (0xC5)

Description: Password for OTP

Bit	Description	Format
15:0	Write value 0x4B6A to this command to enable the burn OTP function (0xD6 command). It is also required that the password is written to command 0xC4.	Byte Array

PASSW_ADDR (0xC6)

Description: Password for ADDRESS

Bit	Description	Format
15:0	Write value 0xF1C0 to this command to enable the custom PMBUS base address setting (0xE0 command). It is also required that the password is written to command 0xC4.	Byte Array

OTP_WRITE (0xCF)

Description: Available # of OTP write cycles

Bit	Description	Format
7:0	Returns how many OTP writes that are left. Use before a 0xD6 command write.	Integer Unsigned

DEVICE_FULL_ADDRESS (0xD3)

Description: Reads PMBus address 8 bit

Bit	Description	Format
7:0	Returns the PMBus device address aligned on 8 bit.	Byte Array

DCX_VOUT_SS_FAULT (0xD4)

Description: Soft start rise check step size

Bit	Description	Format
7:0	Enable/disable and specify the incremental step of the monotonic check in Vout mantissa number. The value is Vout_step (value of Vout PMBUS mantissa) where $Vout(n+1) > Vout(n) + Vout_step$ for a regular soft start. The sampling (n+1) and (n) are defined by the command 0xDF. A value of 0 means monotonic check is disabled. The check is also always disabled when $Vout > 0.5 VOUT_UV_FAULT_LIMIT$.	Integer Unsigned

MFR_IOUT_WARN_TIME (0xD5)

Description: Sets the Twarn time

Bit	Description	Format	Unit
7:0	Twarn is set from 2.2 ms (0x02) to 280 ms (0xFF) with step 1.1 ms. 0x01 is a non-valid value and will cause a CML fault. Twarn controls two functions: 1) ALERT pin assertion time = Twarn. The ALERT pin is triggered by an OC warning or an OT warning event. 2) Timed OCP. An OCP fault is triggered when the Timed OCP counter reaches Twarn/2. The counter is reset after time Twarn. The counter is increased at every 1 ms sample above IOUT_OC_WARN_LIMIT. If set to 0x00 the ALERT pin function and the Timed OCP counter are disabled. If any READ command is received during the Twarn timer, the timer is interrupted to execute the READ command. For each READ command the Twarn time is extended by ~1 ms. Thus, a READ burst will block the timer for a while.	Fixed Point Unsigned	ms

OTP_UPLOAD (0xD6)

Description: Store to OTP command

Bit	Description	Format
7:0	In Write mode, it saves the config values from RAM into OTP memory. Use payload 0xAA. PMBus commands are not accepted, wait 120 ms for the writing time. Before command is written, passwords must be written to 0xC4 and 0xC5. In Read mode, it returns 0xCC = written successfully; 0xFF = it's an error.	Byte Array

NTC_CS_LUT_STATUS (0xD8)

Description: LUT memory area status

Bit	Description	Value	Function	Description
7:0	Returns the status of the LUT memory area: If 0x01, LUT NTC stored If 0x02, LUT CS stored If 0x03, LUT NTC and CS stored	0x00	No LUT stored	No LUT stored.
		0x01	NTC LUT stored	NTC LUT stored.
		0x02	CS Gain LUT stored	CS Gain LUT stored.
		0x03	NTC and CS Gain LUTs stored	NTC and CS Gain LUTs stored.

IMON_ITH1 (0xD9)

Description: READ_IOUT Calibration Threshold 1

Bit	Function	Description	Format	Unit
15:11	Linear exponent	Must be set to -2.	Integer Signed	
10:0	READ_IOUT calibration threshold 1	Specifies the threshold of output current over which a post-processing gain scaling according to command IMON_GAIN_OVER_ITH1 shall be applied. Set to 0 if unused.	Fixed Point Unsigned	A

IMON_GAIN_OVER_ITH1 (0xDA)

Description: READ_IOUT calibration gain over threshold 1

Bit	Description	Format
7:0	Sets a post-processing gain scaling that is applied to READ_IOUT for values above IMON_ITH1: $READ_IOUT = READ_IOUT + IMON_GAIN_OVER_ITH1 \times (READ_IOUT - ITH1)$ Range is 0 to 4 with LSB = 0.015625.	Fixed Point Unsigned

IMON_ITH2 (0xDB)

Description: READ_IOUT Calibration Threshold 2

Bit	Function	Description	Format	Unit
15:11	Linear exponent	Must be set to -2.	Integer Signed	
10:0	READ_IOUT calibration threshold 2	Specifies the threshold of output current over which a post-processing gain scaling according to command IMON_GAIN_OVER_ITH2 shall be applied. Set to 0 if unused.	Fixed Point Unsigned	A

IMON_GAIN_OVER_ITH2 (0xDC)

Description: READ_IOUT calibration gain over threshold 2

Bit	Description	Format
7:0	Sets a post-processing gain scaling that is applied to READ_IOUT for values above IMON_ITH2: $READ_IOUT = READ_IOUT + IMON_GAIN_OVER_ITH2 \times (READ_IOUT - ITH2)$ Range is 0 to 4 with LSB = 0.015625.	Fixed Point Unsigned

DCX_SS_PROTECTION (0xDF)

Description: Defines the sampling instants (n+1) and (n) for the command 0xD4.

Bit	Function	Description	Format	Unit
5:3	Initial sample time	From 0.5 ms [000] to 2.25 ms [111], step 0.25 ms.	Fixed Point Unsigned	ms

Bit	Function	Description	Value	Function	Description
2:0	Pace of samples (n) and (n+1)	From 0.75 ms [011] to 1.75 ms [111], step 0.25 ms.	011	0.75 ms	
			100	1.00 ms	
			101	1.25 ms	
			110	1.50 ms	
			111	1.75 ms	

PMBUS_BASE_ADDRESS (0xE0)

Description: Sets the PMBUS base address of the address range. If a store failed and with blank part a default base address set equal to 0x1 (16d). Before command is written, passwords must be written to 0xC4 and 0xC6. After write, input voltage must be cycled before the base address is actually changed.

Bit	Description	Format
7:5	Base Address to start from. 000b => base address 0x00, 001b => base address 0x10, 010b => base address 0x20, 011b => base address 0x30, etc.	Fixed Point Unsigned

NTC_LUT_CRC16_READ (0xE1)

Description: Reads the checksum value for the NTC LUT.

Bit	Description	Format
15:0	NTC LUT CRC16 value.	Integer Unsigned

CS_LUT_CRC16_READ (0xE2)

Description: Reads the checksum value for the CS Gain LUT.

Bit	Description	Format
15:0	CS Gain LUT CRC16 value.	Integer Unsigned

CHECKSUM_CRC (0xEE)

Description: Calculated config file CRC

Bit	Description	Format
15:0	Returns the CRC16 calculated based on the configuration file. At POR and after STORE, the embedded processor compares the CRC16 signature placed in the configuration file with the calculated CRC16. If they don't match, IC enters Recovery mode (no configuration file), triggers the Memory Fault in STATUS_CML and set the PMBUS address to 0xB0.	Direct

REG_CON_OFFSET_IOUT (0xF0)

Description: READ_IOUT calibration offset

Bit	Function	Description	Format	Unit
6:0	READ_IOUT calibration offset value	Setting the offset to the READ_IOUT mantissa: Bit 7 = 0 for positive values and 1 for negative Bit 6:0 = offset of the PMBUS mantissa	Fixed Point Unsigned	A

Bit	Function	Description	Value	Function	Description
7	READ_IOUT calibration offset sign bit	Setting the offset to the READ_IOUT mantissa: Bit 7 = 0 for positive values and 1 for negative Bit 6:0 = offset of the PMBUS mantissa	0	Positive offset	Positive offset.
			1	Negative offset	Negative offset.

REG_CON_MULT_IOUT (0xF1)

Description: READ_IOUT calibration gain

Bit	Description	Format
7:0	Setting the internal gain of the READ_IOUT value.	Fixed Point Unsigned